



VIPA Accessories



ProfiHub B5 | 973-5BE00 | Manual

HB151E | Rev. 12/04

January 2012

Copyright © VIPA GmbH. All Rights Reserved.

This document contains proprietary information of VIPA and is not to be disclosed or used except in accordance with applicable agreements.

This material is protected by the copyright laws. It may not be reproduced, distributed, or altered in any fashion by any entity (either internal or external to VIPA), except in accordance with applicable agreements, contracts or licensing, without the express written consent of VIPA and the business management owner of the material.

For permission to reproduce or distribute, please contact:
VIPA, Gesellschaft für Visualisierung und Prozessautomatisierung mbH
Ohmstraße 4, D-91074 Herzogenaurach, Germany
Tel.: +49 (91 32) 744 -0
Fax.: +49 9132 744 1864
EMail: info@vipa.de
<http://www.vipa.de>

Note

Every effort has been made to ensure that the information contained in this document was complete and accurate at the time of publishing. Nevertheless, the authors retain the right to modify the information. This customer document describes all the hardware units and functions known at the present time. Descriptions may be included for units which are not present at the customer site. The exact scope of delivery is described in the respective purchase contract.

CE Conformity

Hereby, VIPA GmbH declares that the products and systems are in compliance with the essential requirements and other relevant provisions of the following directives:

- 2004/108/EC Electromagnetic Compatibility Directive
- 2006/95/EC Low Voltage Directive

Conformity is indicated by the CE marking affixed to the product.

Conformity Information

For more information regarding CE marking and Declaration of Conformity (DoC), please contact your local VIPA customer service organization.

Trademarks

VIPA, SLIO, System 100V, System 200V, System 300V, System 300S, System 400V, System 500S and Commander Compact are registered trademarks of VIPA Gesellschaft für Visualisierung und Prozessautomatisierung mbH.

SPEED7 is a registered trademark of profichip GmbH.

SIMATIC, STEP, SINEC, S7-300 and S7-400 are registered trademarks of Siemens AG.

Microsoft und Windows are registered trademarks of Microsoft Inc., USA.

Portable Document Format (PDF) and Postscript are registered trademarks of Adobe Systems, Inc.

All other trademarks, logos and service or product marks specified herein are owned by their respective companies.

Information product support

Contact your local VIPA Customer Service Organization representative if you wish to report errors or questions regarding the contents of this document. If you are unable to locate a customer service center, contact VIPA as follows:

VIPA GmbH, Ohmstraße 4, 91074 Herzogenaurach, Germany

Telefax: +49 9132 744 1204
EMail: documentation@vipa.de

Technical support

Contact your local VIPA Customer Service Organization representative if you encounter problems with the product or have questions regarding the product. If you are unable to locate a customer service center, contact VIPA as follows:

VIPA GmbH, Ohmstraße 4, 91074 Herzogenaurach, Germany

Telephone: +49 9132 744 1150 (Hotline)
EMail: support@vipa.de

Product	Order number
ProfiHub B5	VIPA 973-5BE00

The information contained in this manual is supplied without warranties. The information is subject to change without notice.

**Icons
Headings**

Important passages in the text are highlighted by following icons and headings:



Danger!
Immediate or likely danger.
Personal injury is possible.



Attention!
Damages to property is likely if these warnings are not heeded.



Note!
Supplementary information and useful tips.

Contents

Contents	2
Product description	3
Installation	8
Technical Data	13

Important Safety Information for users

Handling of electrostatic sensitive modules

VIPA modules make use of highly integrated components in MOS-Technology. These components are extremely sensitive to over-voltages that can occur during electrostatic discharges.

The following symbol is attached to modules that can be destroyed by electrostatic discharges:



Attention!

Personnel and instruments should be grounded when working on electrostatic sensitive modules!

Product description

General

The ProfiHub B5 PROFIBUS DP repeater in a IP20 casing for industrial automation, to implement long multi-device spur lines and backbone structures with star/tree segments for PROFIBUS DP.

PROFIBUS DP is a high speed communication bus that has to comply with strict rules concerning spur lines, because of possible reflections that could lead to communication disturbances.

It has the functionality of 5 galvanic isolated transparent repeaters. This allows network structures with extended spur lines that individually can handle a maximum of 31 devices and a length equal to the main bus. The ProfiHub B5 refreshes a received message on one channel and transfers it to all the other channels.

Because the ProfiHub B5 creates isolated segments, the devices can now be removed and added during operation. Also electrical bus problems and EMC disturbances in a spur do not spread to the other segments. The intelligent logic and isolation circuits of the ProfiHubs do not change the bit width. This means the ProfiHubs do not have limitations in serial placement. The logic also detects the transmission speed automatically.

To assist the installation work, termination is integrated and can be switched on/off. The grounding concept is also selectable: direct or capacitive grounding.

The ProfiHub B5 is to be powered by DC 10...32V.

For troubleshooting, maintenance and commissioning there are LEDs at the front side of the ProfiHub B5

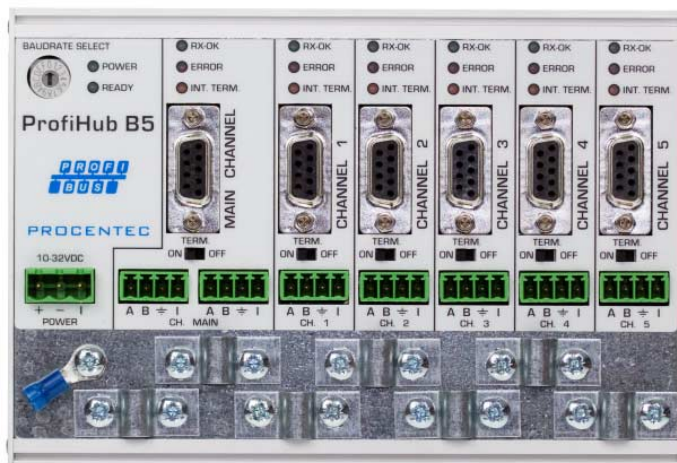

Order data

Type	Order number	Description
ProfiHub B5	973-5BE00	5 channel PROFIBUS DP Repeater

Features

- 5 Galvanic isolated channels (repeater segments).
- Transparent for all PROFIBUS DP protocols
- DP - RS 485 specifications for each channel.
- 9.6kbps to 12Mbps
- 31 devices per channel
- 1200 m spur line length (depends on transmission speed)
- No limit in serial placement or cascading of ProfiHubs
- No PROFIBUS address required
- Integrated termination facilities (switches)
- Configurable grounding system (direct or capacitive).
- IP 20 classification (according to DIN 40 050)

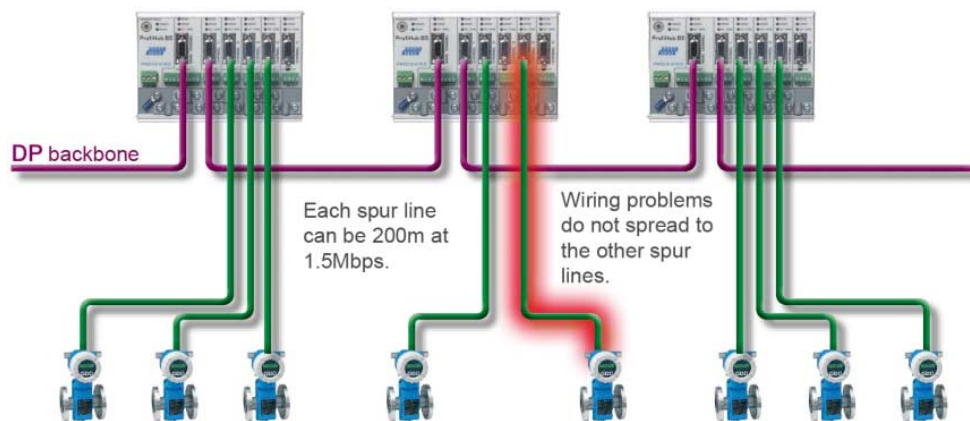
**Application areas**

- Dynamic spur lines to actuators, flow meters and pH analyzers.
- Removable drives and motors
- Pull/Plug motor control centers (drawers)
- Roof mounted devices in tank farms
- Dirty and humid environments
- Barrier for non galvanic isolated equipment
- Large star/tree structured networks

Additional Benefits

- Hot slave insertion and removal during operation
- Short circuit protection on each channel
- Compact and robust construction
- Status and error display (per channel)
- Suitable for all DP cables
- Conveniently arranged networks
- Easy extendable installations

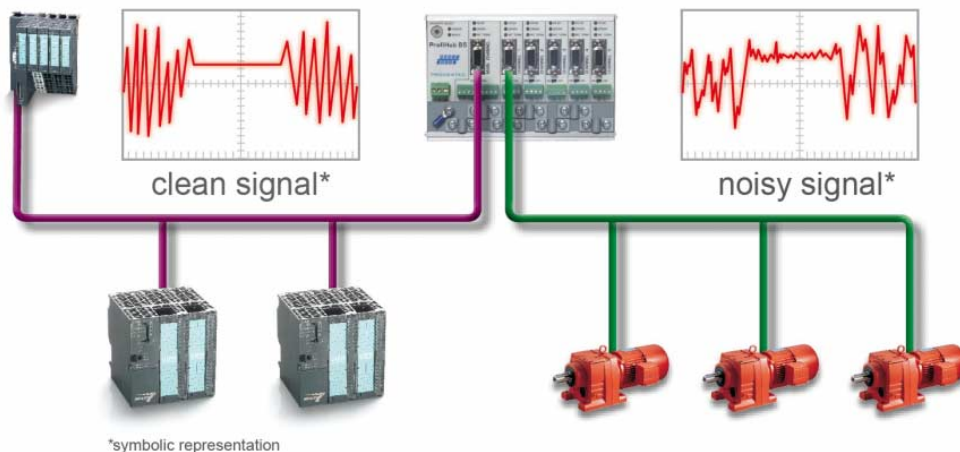

Channel structure

Every channel is electrically isolated and internally connected to the transparent intelligent backbone. The termination is switchable and powered by the ProfiHub. The shielding of the PROFIBUS cable can be directly grounded or indirectly grounded.

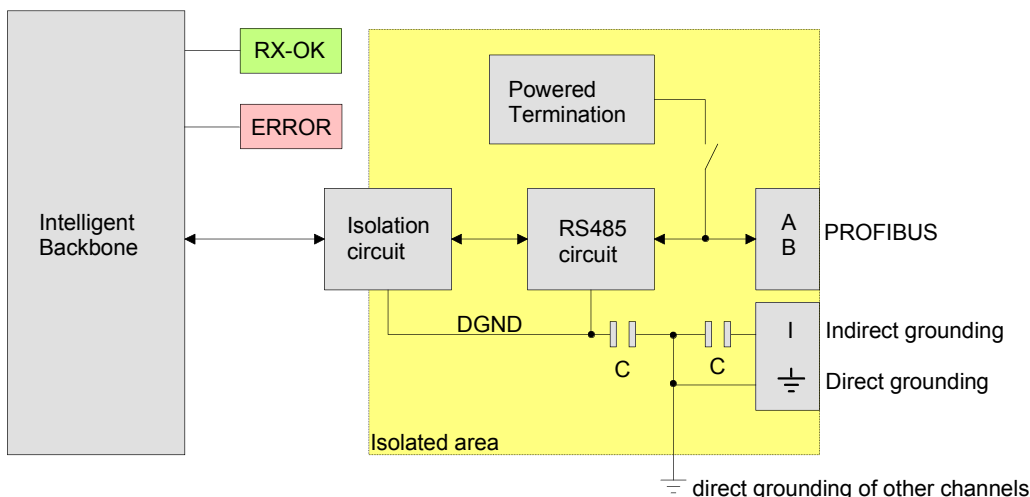

Grounding System The ProfiHub can be grounded by 3 methods:

- Direct grounding
- Indirect grounding (through a capacitor)
- Combination of direct and indirect

In most cases it is recommended always to use Direct Grounding with the power supply and the shielding of the PROFIBUS cables. If you do not want to ground all or some cables to the common ground, the cable shielding should be connected to pin "I". A capacitor with a parallel high value resistor will separate the 2 potentials.

If by accident on 1 channel the Direct Grounding is connected with the Indirect Grounding, the Direct Grounding "wins".

Cable length for PROFIBUS DP The cables on the channels and the Main Channel should comply with the PROFIBUS DP cable specifications for RS485.

Baudrate (kbit/s)	9.6	19.2	45.45	93.75	187.5	500	1500	3000	6000	12000
Segment length (m)	1200	1200	1200	1200	1000	400	200	100	100	100
Segment length (feet)	3940	3940	3940	3940	3280	1310	656	328	328	328

Cable types for PROFIBUS DP The cable type should comply with the PROFIBUS DP cable specifications for RS 485.

Parameter	Value
Wires	2 (twisted)
Impedance	150Ohm (3 ... 20MHz)
Capacity	< 30pF/m
Loop resistance	< 110Ohm/km
Wire diameter	> 0.64mm
Wire area	> 0.32mm

Diagnostic LEDs

LED	Color	Description
Power	green	○ Power is not switched on or an internal failure
		⚡ Power supply not stable or an internal failure
		● Power supply OK
READY	green	○ Power is not switched on or an internal failure
		⚡ Trying to detect the transmission speed, but has not locked it yet
		● The transmission speed has been detected
Main RX-OK	green	○ No communication detected on the Main Channel
		⚡ 1 or more devices communicating on the Main Channel
		● 1 or more devices communicating on the Main Channel
Main ERROR	red	○ No problem has been detected
		⚡ Problem in the cabling has been detected (Main Channel)
		● Problem in the cabling has been detected (Main Channel)
Main INT. TERM.	yellow	○ Termination off (Main Channel)
		● Termination on (Main Channel)
Channel RX-OK	green	○ There is no communication detected (on this channel)
		⚡ 1 or more devices communicating (on this channel)
		● 1 or more devices communicating (on this channel)
Channel ERROR	red	○ No problem has been detected
		⚡ Problem in the cabling has been detected (on this channel)
		● Problem in the cabling has been detected (on this channel).
Channel INT. TERM.	yellow	○ Termination off (on this channel)
		● Termination on (on this channel)

off: ○ blinking: ⚡ on: ●

Installation

Location The ProfiHub B5 can be installed everywhere in a non-hazardous area that complies with IP 20 (DIN 40 050) and the specified temperature range of -20 to +75°C.

Position The ProfiHub B5 can be installed in every position, but it is recommended to install it with the cables pointing down. In this position it is also easier to read the status display.

Mounting The ProfiHub B5 has to be mounted on 35mm DIN rail with a minimum width of 167mm.

Power Supply

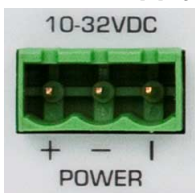

The 3-pole screw type power connector is located on the bottom left of the ProfiHub B5.

PIN	Wiring
+	+
-	-
I	Indirect grounding

The power supply has to comply with the following specifications:

Voltage: DC 10 ... 32V

Current: Min. 130mA

Wire diameter: < 2.5mm²

Procedure

To connect the 24V supply to the 3-pole screw-type terminal, proceed as follows:

- Strip the insulation from the cable or the conductors for the 24V power supply.
- Secure the conductors in the screw-type terminal



Note!

There is a grounding point that can be used.

To connect the power supply, you need a 3mm screwdriver.

Diagnose

If the power is switched on it can be diagnosed by the following indicators:

- All the LEDs should be shortly blinking.
- The POWER LED is ON.
- The READY LED is ON or blinking.



Note!

It is recommended to use a power supply with a ground lead (3-wire).

Backbone

Connect the DP backbone cable to the bottom-left connector of the Main Channel. If the ProfiHub is not the last device on the bus segment, connect the Bus-Out cable to the right connector of the Main Channel. The second method is to place a PROFIBUS standardized plug with an in/out cable on the DB9 connector.

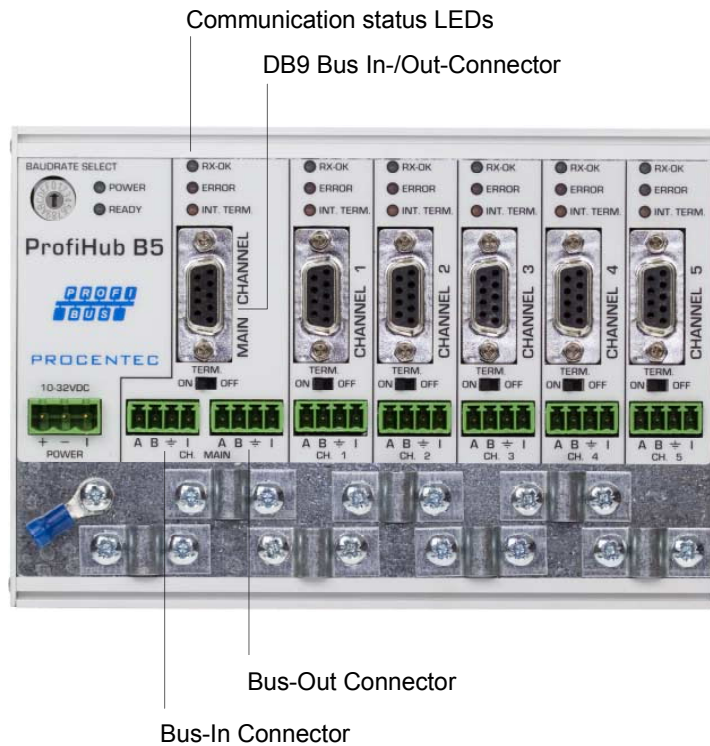

Pin layout



PIN (Clamp)	Wiring
A	green wire
B	red wire
\perp	Cable shielding <i>or</i>
I	Cable shielding

LED

If the Main Channel recognizes valid PROFIBUS messages from 1 or more connected devices, the RX-OK LED of this channel should be blinking.

Spur segments

Connect the spur segments to the connectors of channel 1 to 5. The second method is to place a PROFIBUS standardized plug on the DB9 connector of the specific channel.

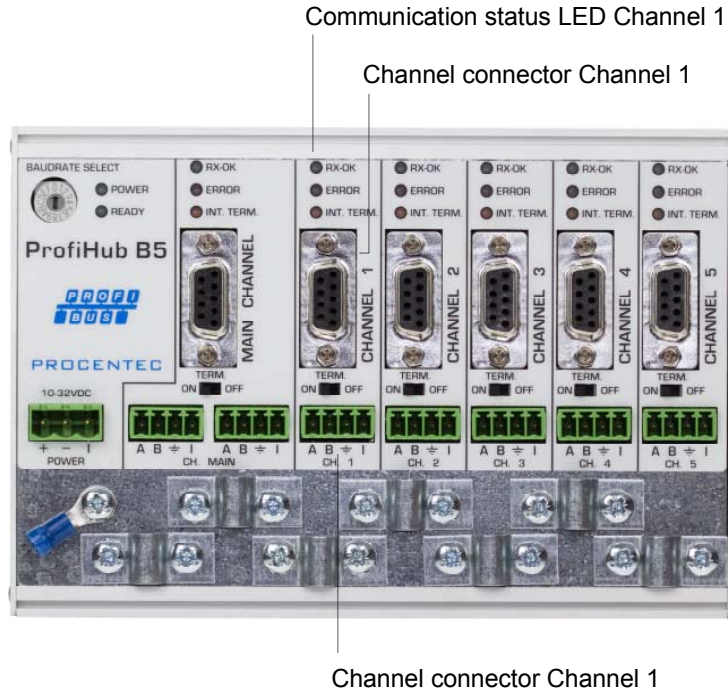

Pin layout

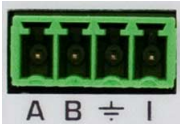

Pin (Clamp)	Wiring
A	green wire
B	red wire
⊥	Cable shielding <i>or</i>
I	Cable shielding



Note!

Connecting the cable shielding is not required when the ground clips are used.

LED

If the Main Channel recognizes valid PROFIBUS messages from 1 or more connected devices, the RX-OK LED should be blinking.

Termination

The termination of the Main Channel has been set to OFF by default. If the ProfiHub is the last device on the bus, the termination should be set to ON.

The termination of the channels have been set to ON by default. Because it is assumed that the new segment is started at the ProfiHub.

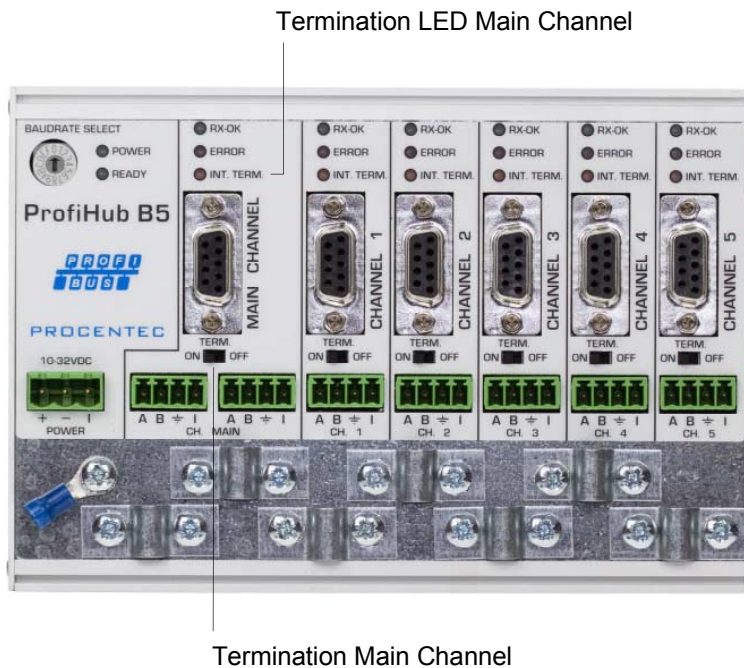

The termination LED of the specific channel is activated when the termination switch is set to ON.



Note!

When the DB9 connector is used and the cable starts at the ProfiHub, it is recommended to use the termination on the DB9 plug and NOT the ProfiHub.

Baudrate switch

The ProfiHub B5 recognizes the transmission speed by default. If it is required that the ProfiHub B5 is locked to a certain transmission speed, the baudrate switch should be set to the required value.

Baudrate speed
switch



Settings	Values
0	Auto detect (Default)
1	9.6kbps
2	19.2kbps
3	45.45kbps
4	93.75kbps
5	187.5kbps
6	500kbps
7	1500kbps
8	3000kbps
9	6000kbps
A	12000kbps
B ... F	Auto detect

**Note!**

To set the transmission speed, you need a 3mm screwdriver.

Technical Data

Order number	973-5BE00
Type	ProfiHub B5
Dimensions and weight	
Dimensions (LxWxH) in mm	167x111x32 (with screws)
Weight	650g
Environmental conditions	
Operating temperature	-20 to +75°C
Isolation class	IP 20 (DIN 40 050)
Protocol specifications	
Supported protocols	DP-V0, DP-V1, DP-V2, FDL, MPI, FMS, PROFIsafe, PROFIdrive and any other protocol auf FDL-Basis
Transmission speed	9.6kbps to 12Mbps (including 45.45kbps)
Transmission speed detection	Auto detect (default) or settable with a rotary switch
Transmission speed switch	< 10s (if it set to auto detect)
Data delay time	1.25Tbit at 9.6kbps to 93.75kbps 1.3Tbit at 187.5kbps to 500kbps 1.4Tbit at 1.5Mbps 1.6Tbit at 3Mbps 2.0Tbit at 6Mbps 3.0Tbit at 12Mbps
Delay time jitter	Max. 1/4 bit time
Specification PROFIBUS cable	
Cable lengths	1200m at 9.6kbps to 93.75kbps 1000m at 187.5kbps 400m at 500kbps 200m at 1.5Mbps 100m at 3Mbps to 12Mbps
Cable thickness	10mm (when the ground rail is used)
Wire diameter	< 2.5mm ²
Wire type	Stranded or solid core
Number of devices	max. 31 per channel (including ProfiHubs, OLMs, PCs)
Termination	Integrated and switchable Powered according to IEC 61158 (390/220/390 Ohm) - all channels (default on) - main channel (default off)
Cascading depth	no limits
Redundancy	no
Power supply specifications	
Nominal supply voltage	DC 10 ... 32V
Current consumption	130mA at DC 24V power supply (all channels fully loaded)
Power dissipation	max. 4.1W

Reverse polarity protection	yes
Cable thickness	10mm (when the ground rail is used)
Wire diameter	< 2.5mm ²
Others	
MTBF	398723 hours according to IEC62380 (RDF-2000 / UTE C 80-810, mathematical model for failure rates).