



VIPA Accessories



Teleservice module | 900-2E651 | Manual

HB39E_TM | RE_900-2E651 | Rev. 10/16

April 2010

Copyright © VIPA GmbH. All Rights Reserved.

This document contains proprietary information of VIPA and is not to be disclosed or used except in accordance with applicable agreements.

This material is protected by the copyright laws. It may not be reproduced, distributed, or altered in any fashion by any entity (either internal or external to VIPA), except in accordance with applicable agreements, contracts or licensing, without the express written consent of VIPA and the business management owner of the material.

For permission to reproduce or distribute, please contact:
VIPA, Gesellschaft für Visualisierung und Prozessautomatisierung mbH
Ohmstraße 4, D-91074 Herzogenaurach, Germany
Tel.: +49 (91 32) 744 -0
Fax.: +49 9132 744 1864
EMail: info@vipa.de
<http://www.vipa.de>

Note

Every effort has been made to ensure that the information contained in this document was complete and accurate at the time of publishing. Nevertheless, the authors retain the right to modify the information. This customer document describes all the hardware units and functions known at the present time. Descriptions may be included for units which are not present at the customer site. The exact scope of delivery is described in the respective purchase contract.

CE Conformity

Hereby, VIPA GmbH declares that the products and systems are in compliance with the essential requirements and other relevant provisions of the following directives:

- 2004/108/EC Electromagnetic Compatibility Directive
- 2006/95/EC Low Voltage Directive

Conformity is indicated by the CE marking affixed to the product.

Conformity Information

For more information regarding CE marking and Declaration of Conformity (DoC), please contact your local VIPA customer service organization.

Trademarks

VIPA, SLIO, System 100V, System 200V, System 300V, System 300S, System 400V, System 500S and Commander Compact are registered trademarks of VIPA Gesellschaft für Visualisierung und Prozessautomatisierung mbH.

SPEED7 is a registered trademark of profichip GmbH.

SIMATIC, STEP, SINEC, S7-300 and S7-400 are registered trademarks of Siemens AG.

Microsoft und Windows are registered trademarks of Microsoft Inc., USA.

Portable Document Format (PDF) and Postscript are registered trademarks of Adobe Systems, Inc.

All other trademarks, logos and service or product marks specified herein are owned by their respective companies.

Information product support

Contact your local VIPA Customer Service Organization representative if you wish to report errors or questions regarding the contents of this document. If you are unable to locate a customer service center, contact VIPA as follows:

VIPA GmbH, Ohmstraße 4, 91074 Herzogenaurach, Germany

Telefax: +49 9132 744 1204
EMail: documentation@vipa.de

Technical support

Contact your local VIPA Customer Service Organization representative if you encounter problems with the product or have questions regarding the product. If you are unable to locate a customer service center, contact VIPA as follows:

VIPA GmbH, Ohmstraße 4, 91074 Herzogenaurach, Germany

Telephone: +49 9132 744 1150/1180 (Hotline)
EMail: support@vipa.de

Contents

About this manual	1
Safety information.....	2
Chapter 1 Assembly and installation guidelines.....	1-1
Safety information for Users.....	1-2
Installation of the SIM card.....	1-3
Installation dimensions	1-5
Assembly.....	1-6
Cabling.....	1-8
Installation guidelines.....	1-9
Chapter 2 Hardware description	2-1
Properties.....	2-2
Structure	2-3
Technical Data	2-8
Chapter 3 Deployment TM	3-1
Fast introduction.....	3-2
Assembly.....	3-5
Cabling.....	3-6
TM - Configuration - eBuddy	3-7
TM - Reset	3-13
TM - Web page	3-14
TM - PLC linking.....	3-16
TM - Project integration - PG/PC interface via NetPro.....	3-19
TM - Project integration - PG/PC interface via eVCOM	3-24
Installation of the SIM card.....	3-26
Deployment of Tags	3-28
Teleservice via telephone with MPI gateway	3-31
Teleservice via Callback function	3-35
Teleservice via SMS.....	3-39
Appendix.....	A-1
Index	A-1

About this manual

Important note! The information in this manual should simplify you the deployment of remote controlling VIPA PLCs. More information concerning this may be found in German and English at:

support.ewon.biz
www.ewon-online.de

This Teleservice module TM-E from VIPA is constructed in the same way as the module "eWON2001".

Overview

Chapter 1: Assembly and installation guidelines

In this chapter you will find all information, required for assembly and installation of the Teleservice module (TM).

Chapter 2: Hardware description

Here the hardware components of the Teleservice module (TM) are more described.

The technical data are at the end of this chapter.

Chapter 3: Deployment

This chapter concerns on the deployment of the Teleservice module (TM) from VIPA with a PLC. With the fast introduction you will get an overview about the possibilities of the Teleservice module. Another part of this chapter is the configuration of the TM by means of the integrated Web page.

This chapter ends with the possibilities of the teleservice functions.

Objective and contents

This manual describes the Teleservice module TM-E GSM/GPRS Router Quadband from VIPA. It contains a description of the construction, project implementation and usage.

This manual is part of the documentation package with order number VIPA HB39E_TM and relevant for:

Product	Order number	as of state: TM-FW
TM-E GSM/GPRS Router Quadband	VIPA 900-2E651	5.6

Target audience

The manual is targeted at users who have a background in automation technology.

Structure of the manual

The manual consists of chapters. Every chapter provides a self-contained description of a specific topic.

Guide to the document

The following guides are available in the manual:

- an overall table of contents at the beginning of the manual
- an overview of the topics for every chapter
- an index at the end of the manual.

Availability

The manual is available in:

- printed form, on paper
- in electronic form as PDF-file (Adobe Acrobat Reader)

Icons Headings

Important passages in the text are highlighted by following icons and headings:



Danger!

Immediate or likely danger.
Personal injury is possible.



Attention!

Damages to property is likely if these warnings are not heeded.



Note!

Supplementary information and useful tips

Safety information

Applications conforming with specifications

The Teleservice module is constructed and produced for:

- communication and process control
- general control and automation applications
- industrial applications
- operation within the environmental conditions specified in the technical data
- installation into a cubicle



Danger!

This device is not certified for applications in

- in explosive environments (EX-zone)

Documentation

The manual must be available to all personnel in the

- project design department
- installation department
- commissioning
- operation



The following conditions must be met before using or commissioning the components described in this manual:

- Modification to the process control system should only be carried out when the system has been disconnected from power!
- Installation and modifications only by properly trained personnel
- The national rules and regulations of the respective country must be satisfied (installation, safety, EMC ...)

Disposal

National rules and regulations apply to the disposal of the unit!

Chapter 1 Assembly and installation guidelines

Overview In this chapter you will find all information, required for assembly and installation of the Teleservice module (TM).

Content	Topic	Page
	Chapter 1 Assembly and installation guidelines.....	1-1
	Safety information for Users.....	1-2
	Installation of the SIM card.....	1-3
	Installation dimensions.....	1-5
	Assembly.....	1-6
	Cabling.....	1-8
	Installation guidelines.....	1-9

Safety information for Users

Handling of electrostatic sensitive modules

VIPA modules make use of highly integrated components in MOS-Technology. These components are extremely sensitive to over-voltages that can occur during electrostatic discharges.

The following symbol is attached to modules that can be destroyed by electrostatic discharges.



The Symbol is located on the module, the module rack or on packing material and it indicates the presence of electrostatic sensitive equipment.

It is possible that electrostatic sensitive equipment is destroyed by energies and voltages that are far less than the human threshold of perception. These voltages can occur where persons do not discharge themselves before handling electrostatic sensitive modules and they can damage components thereby, causing the module to become inoperable or unusable.

Modules that have been damaged by electrostatic discharges can fail after a temperature change, mechanical shock or changes in the electrical load.

Only the consequent implementation of protection devices and meticulous attention to the applicable rules and regulations for handling the respective equipment can prevent failures of electrostatic sensitive modules.

Shipping of electrostatic sensitive modules

Modules must be shipped in the original packing material.

Measurements and alterations on electrostatic sensitive modules

When you are conducting measurements on electrostatic sensitive modules you should take the following precautions:

- Floating instruments must be discharged before use.
- Instruments must be grounded.

Modifying electrostatic sensitive modules you should only use soldering irons with grounded tips.



Attention!

Personnel and instruments should be grounded when working on electrostatic sensitive modules.

Installation of the SIM card



Caution!

Please regard the SIM card may only be plugged if you have configured it at the TM Web page, before. Else your SIM card may be blocked!

Preconditions

For the further approach it is precondition that you have access to the Web page of the TM and you have a valid GSM SIM card with PIN.

Configuration at the Web page

- Open the Web page of the Teleservice module.
- Navigate via **Configuration** > *System setup* to the page "Communication".
- Open at the navigation tree **Interfaces** the page "Modem".
- At "GSM PIN" type in the pin number, which is delivered with your SIM card. Leave every values at default setting and click at [Update].

Installing the SIM card

The slot for the SIM card is located at the rear-side of the module. The SIM card should be installed before the assembly. The installation happens with the following approach:

- Switch off the power supply of the Teleservice module.
- Insert the SIM card as shown to the SIM card slot. Please regard here the correct positioning!

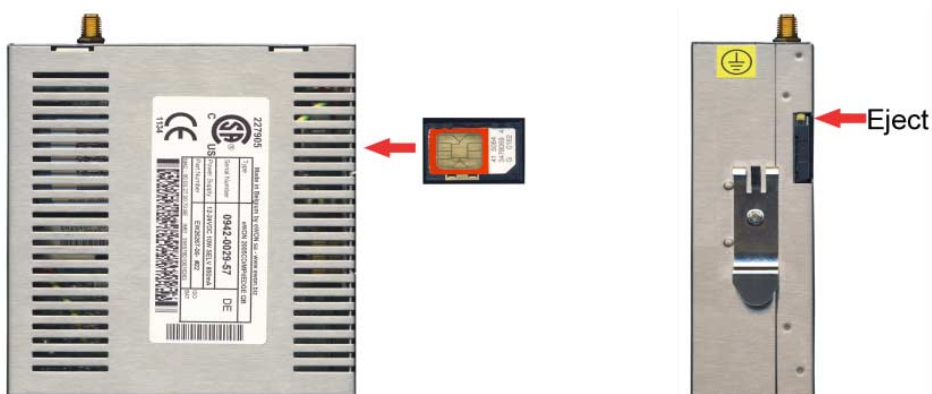

- For taking the SIM cart push the eject button with a pointed object. The eject button may be found above the card slot.

Commissioning with SIM card

- Connect if not just happened a suited antenna. The Teleservice module has a an antenna jack. Here a GSM dual band antenna may be connected. The TM is delivered without any antenna. You may get a suited antenna from VIPA.
You find the order numbers in this manual under "Properties".
- Switch-on again the power supply of the TM. With a cold restart it may last up to 2 minutes until the GSM modem is been rebooted and initialized.
- Open the Web page of the Teleservice module.
- Navigate via **Configuration** > *System setup* to the page "Communication".
- Open in the navigation tree **Interfaces** the page "Modem".

If you have made everything correctly and your GSM modem is connected to a mobile network, the following parameters are listed:

Modem detected	This parameter shows you the type of the internal modem. Here the text "internal Multiband GSM" should be shown.
Signal level	Here the signal level 0...99 is shown. This value is determined once a minute. For a communication connection this value should be higher than 17. A value of 25 corresponds to a good connection. If a value is higher than 30 this correspond to an excellent connection. A signal level of 0 indicates a non existing mobile network.
Network	"Home Network" is shown if the SIM card is operated in the country of which the SIM card is from. If the Teleservice module is operated in an other country, "Roaming" is shown. Otherwise the following error messages may be displayed with his parameter: - "SIM card error!" if SIM card is missing - "PIN code error!" if PIN is faulty - "in operation..." the modem tries to connect to a mobile network.
Operator	Here the name of your mobile network provider is listed.

Installation dimensions

Dimensions

Make sure that a clearance of at least 100mm exists above and 70mm below the middle of the bus rail.

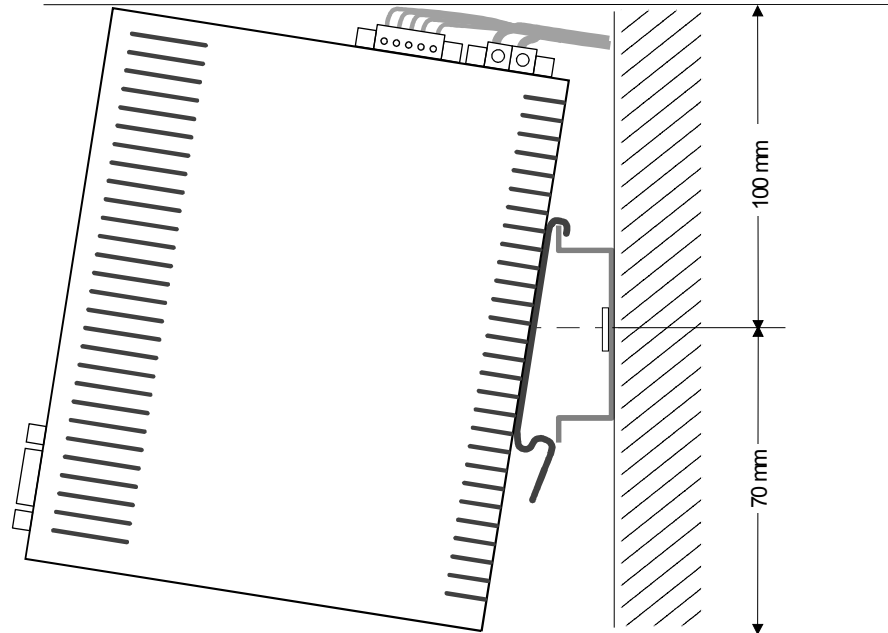

Dimensions assembled

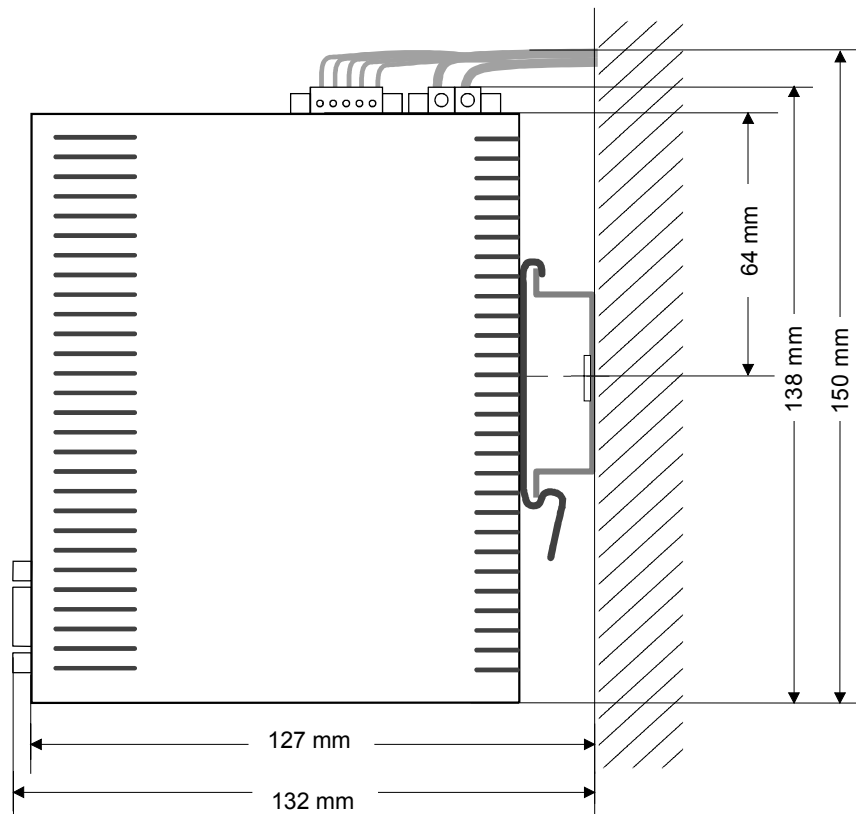

Assembly

General

The modules are installed on a profile rail. You may use the following standard 35mm profile rail:

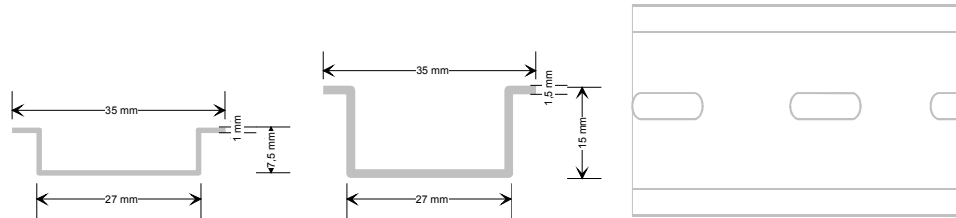

Assembly procedure

The following sequence represents the assembly procedure as viewed from the side.

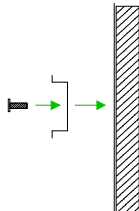

- Install the profile rail. Make sure that a clearance of at least 100mm exists above and 70mm below the middle of the profile rail.

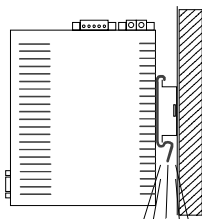
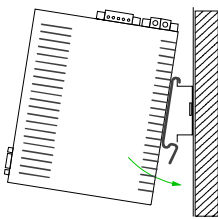
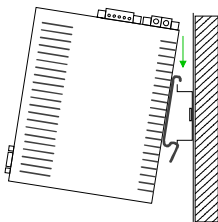

Click

- Insert the module that you are installing into the profile rail at an angle of about 45 degrees from the top and rotate the module into place until it clicks into the profile rail with an audible click.

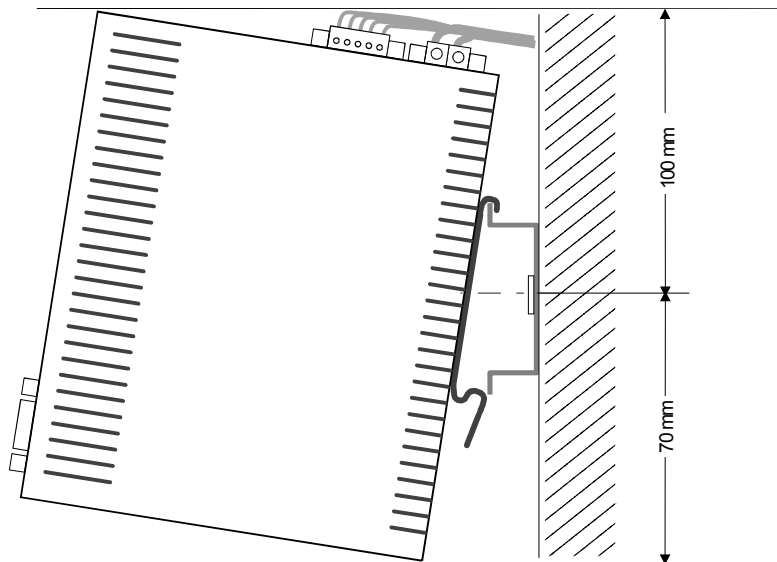

Removal procedure

The following sequence shows the steps required for the removal of modules in a side view.

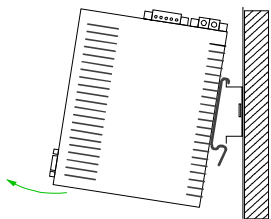

- For the removal take the module at the bottom and pull it forward with a strong jerk.

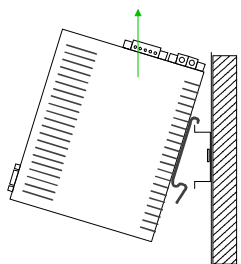

- Now withdraw the module with a slight rotation to the top.

Cabling

Overview

At the upper side of the Teleservice module there are connectors for power supply and digital inputs/outputs. The output is designed as low-side output and may be configured.

The connectors are plugs with screw contacts. If connected the plugs may be fixed with screws.

The I/Os are controlled by *Tags*. An example may be found at the chapter "Deployment" at "Deployment of Tags".

Power supply

The Teleservice module is to be supplied by DC 12...24V ±20%.

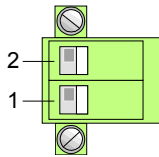

Pin	Name	Meaning
2	12-24V DC	DC 12 ... 24V ±20%
1	GND	Ground power supply

DI/DO connection

The output is designed as low-side output and may be configured.

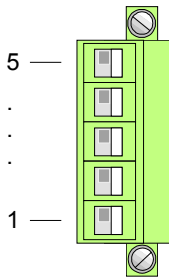

Pin	Name	Meaning
5	DI	Digital input DC 0/24V "0": 0 ... 5V DC "1": 10V ... 30V DC
4	DI_GND	DI ground (isolated)
3	DO_VDC	DO load voltage DC 24V
2	DO	Digital output DC 24V, 0.2A Low-side output
1	DO_GND	DO ground

DI/DO wiring schematic diagram

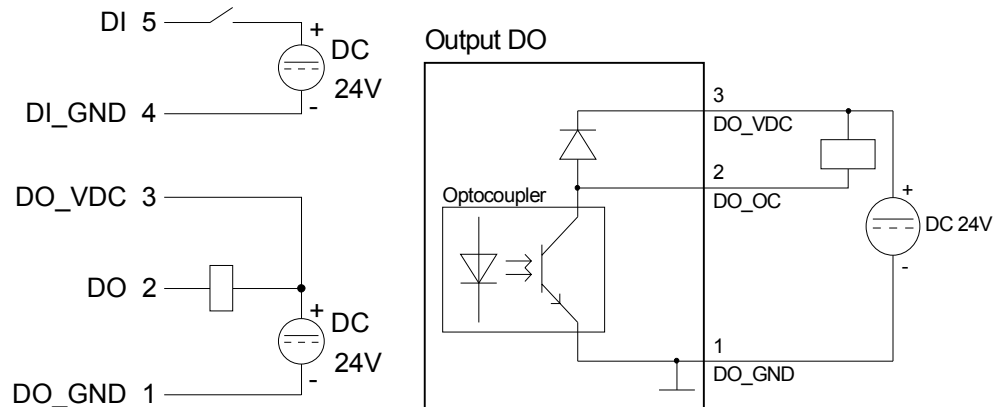

Installation guidelines

General The installation guidelines contain information about the possible interference causes. Here we describe possible ways of interference that may disturb the controlling system and how you have to approach shielding and screening issues to ensure the electromagnetic compatibility (EMC).

What is EMC? Electromagnetic digestibility (EMC) means the ability of an electrical device, to function error free in an electromagnetic environment without being interferenced res. without interfering the environment.
The Teleservice module is developed for applications in harsh industrial environments and they comply with EMC requirements to a large degree. In spite of this you should implement an EMC strategy before installing your SPS and the Teleservice module, which should include any possible source of interference.

Possible interference causes Electromagnetic interferences may interfere your control via different ways:

- Fields
- I/O signal conductors
- Bus system
- Current supply
- Protected earth conductor

Depending on the spreading medium (lead bound or lead free) and the distance to the interference cause, interferences to your control occur by means of different coupling mechanisms.

One differs:

- galvanic coupling
- capacitive coupling
- inductive coupling
- radiant coupling

Basic rules for EMC

In the most times it is enough to take care of some elementary rules to guarantee the EMC. Please regard the following basic rules when installing your PLC.

- Take care of a correct area-wide grounding of the inactive metal parts when installing your components.
 - Install a central connection between the ground and the protected earth conductor system.
 - Connect all inactive metal extensive and impedance-low.
 - Please try not to use aluminum parts. Aluminum is easily oxidizing and is therefore less suitable for grounding.
- When cabling, take care of the correct line routing.
 - Organize your cabling in line groups (high voltage, current supply, signal and data lines).
 - Always lay your high voltage lines and signal res. data lines in separate channels or bundles.
 - Route the signal and data lines as near as possible beside ground areas (e.g. suspension bars, metal rails, tin cabinet).
- Proof the correct fixing of the lead isolation.
 - Data lines must be laid isolated.
 - Analog lines must be laid isolated. When transmitting signals with small amplitudes the one sided laying of the isolation may be favorable.
 - Lay the line isolation extensively on an isolation/protected earth conductor rail directly after the cabinet entry and fix the isolation with cable clamps.
 - Make sure that the isolation/protected earth conductor rail is connected impedance-low with the cabinet.
 - Use metallic or metalized plug cases for isolated data lines.
- In special use cases you should appoint special EMC actions.
 - Wire all inductivities with erase links, which are addressed by your PLC.
 - For lightening cabinets you should prefer incandescent lamps and avoid luminescent lamps.
- Create a homogeneous reference potential and ground all electrical operating supplies when possible.
 - Please take care for the targeted employment of the grounding actions. The grounding of the PLC is a protection and functionality activity.
 - Connect installation parts and cabinets with your PLC in star topology with the isolation/protected earth conductor system. So you avoid ground loops.
 - If potential differences between installation parts and cabinets occur, lay sufficiently dimensioned potential compensation lines.

Isolation of conductors

Electrical, magnetic and electromagnetic interference fields are weakened by means of an isolation, one talks of absorption.

Via the isolation rail, that is connected conductive with the rack, interference currents are shunt via cable isolation to the ground. Hereby you have to make sure, that the connection to the protected earth conductor is impedance-low, because otherwise the interference currents may appear as interference cause.

When isolating cables you have to regard the following:

- If possible, use only cables with isolation tangle.
- The hiding power of the isolation should be higher than 80%.
- Normally you should always lay the isolation of cables on both sides. Only by means of the both-sided connection of the isolation you achieve high quality interference suppression in the higher frequency area.
Only as exception you may also lay the isolation one-sided. Then you only achieve the absorption of the lower frequencies. A one-sided isolation connection may be convenient, if:
 - the conduction of a potential compensating line is not possible
 - analog signals (some mV res. μ A) are transferred
 - foil isolations (static isolations) are used.
- With data lines always use metallic or metalized plugs for serial couplings. Fix the isolation of the data line at the plug rack. Do not lay the isolation on the PIN 1 of the plug bar!
- At stationary operation it is convenient to strip the insulated cable interruption free and lay it on the isolation/protected earth conductor line.
- To fix the isolation tangles use cable clamps out of metal. The clamps must clasp the isolation extensively and have well contact.
- Lay the isolation on an isolation rail directly after the entry of the cable in the cabinet. Lead the isolation further on to the PLC and **don't** lay it on there again!

**Please regard at installation!**

At potential differences between the grounding points, there may be a compensation current via the isolation connected at both sides.

Remedy: Potential compensation line

Chapter 2 Hardware description

Overview Here the hardware components of the Teleservice module (TM) are more described.
The technical data are at the end of this chapter.

Content	Topic	Page
	Chapter 2 Hardware description	2-1
	Properties	2-2
	Structure	2-3
	Technical Data	2-8

Properties

Overview

The TM-E is an intelligent Teleservice module. This module makes simple and safe communication with your machines and plants possible via telephone respectively internet. Values of your plant may be observed and appropriate reactions to limit exceeds may be configured.

Here e.g. plant data may be collected and sent via mail. Due to the integrated Web page, for configuration there is no additional software necessary.

Due to the predefined server the embedding to a VIPA PLC may be established problem-free. The TM may be integrated as PG/OP interface to the Siemens SIMATIC manager by means of a station file.

Properties

- Transparent Ethernet-Gateway with TCP/IP Router
- Sending alarms by E-Mail and SMS (only via free SMS provider)
- up to 20 Ethernet sessions simultaneous
- Programmable gateway by BASIC
- fully customizable web pages (in HTML)
- integrated alarm management
- RS485 MPI/Profibus DP interface
- RJ45 Ethernet interface
- integrated GSM/GPRS Quadband-Modem - GSM 900MHz / DCS 1800MHz and GSM 850MHz / PCS 1900MHz
- Slot for SIM card

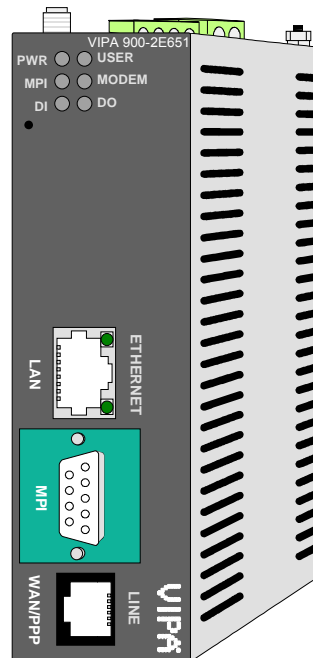

Order data

Type	Order number	Description
TM-E GSM/GPRS Router Quadband	VIPA 900-2E651	DC 12 ... 24V, GSM/GPRS, MPI/Profibus DP, Ethernet RJ45, router functions, DI 1xDC 24V, DO 1xDC 24V 0.2A
TM-Antenna	VIPA 900-0AA00	Dipole antenna with SMA plug
TM-Antenna	VIPA 900-0AB50	Mobile antenna incl. 5m cable and SMA plug
TM-Antenna	VIPA 900-0AQ50	Rod antenna incl. 5m cable and SMA plug

Structure

TM-E GSM/GPRS Router Quadband

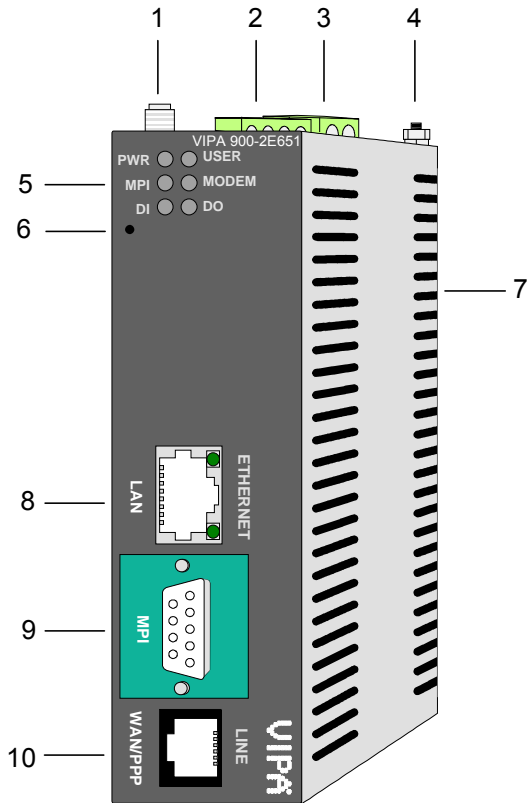

- [1] SMA antenna jack with male thread
- [2] Connector for digital I/O
- [3] Connector for DC 12...24V power supply
- [4] Earthing screw
- [5] LEDs
- [6] Reset button
- [7] Slot for SIM card
- [8] LAN RJ45 Ethernet interface
- [9] RS485 MPI/Profibus DP interface
- [10] not connected

Components

LEDs

At the front-side of the Teleservice module there are two rows of LEDs. The following table shows you the usage of the LEDs and the according colors:



Label	Color	Meaning
PWR	green	Power supply is active.
USER	green	blinks: The TM module is ready for communication (ca. 20s after PowerOn).
	red	blinks: IP address not valid (just exist).
	red/green	blinks alternating: The TM module is just waiting for an IP address during boot-up. The LED is also used with the Reset. More about this may be found at "TM - Reset".
MPI	green	blinks: The TM module is communicating with the PLC via MPI.
MODEM	green	on: The modem of the TM module is active.
DI	green	on: The digital input of the TM module is "1".
DO	green	on: The digital output of the TM module is "1".

RJ45 Ethernet interface

You may connect your Teleservice module to Ethernet by the RJ45 interface. Via Ethernet the integrated Web page of the TM may be accessed for according configurations.

The interface is automatically adapting to the transfer rate 10 or 100Mbit/s. The jack has the following assignment:

8-pole RJ45 jack:

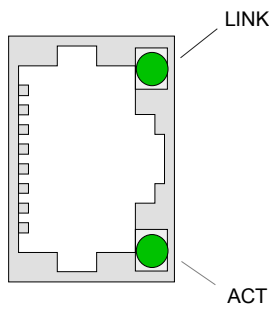

Pin	Assignment
1	Transmit +
2	Transmit -
3	Receive +
4	-
5	-
6	Receive -
7	-
8	-

Linking to Ethernet

Connect your PC to your TM via Ethernet. Here either a crossed cable or a switch may be used.

An active link via Ethernet is shown by the Teleservice module with the upper green "LINK" led. Blinks the lower green "ACT" led the TM module communicates via Ethernet (activity).

The TM is delivered with the following IP address parameters:

IP address: 10.0.0.53
Subnet mask: 255.255.255.0

To change the IP address parameters the configuration tool "eBuddy" from VIPA may be used.

MPI/Profibus DP interface

The Teleservice module is connected to your PLC CPU via this interface. The interface is designed as RS485 jack and has the following assignment:

9-pole SubD jack:

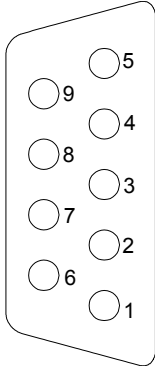

Pin	Assignment
1	n.c.
2	n.c.
3	RxD/TxD (line B)
4	n.c.
5	GND
6	n.c.
7	n.c.
8	RxD/TxD (line A)
9	n.c.

Reset

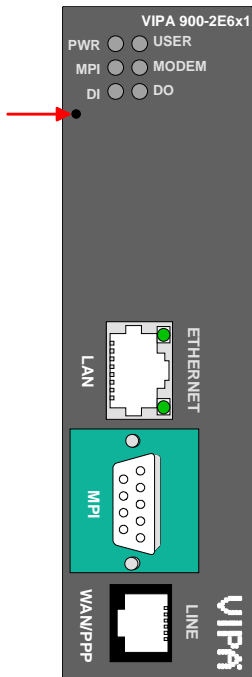

A reset at the Teleservice module may be initiated by the Reset button. The Reset button is allocated below the LEDs behind an opening. Please use for operation a pointed object.

With the reset (*user reset*) extra created Web pages and Tag configurations are erased. Here the communication settings are still remaining.

For a *complete reset* please contact the VIPA support. More about the deployment of the Reset button may be found at "TM - Reset".



Caution!

An unauthorized *complete reset*, which possibly was not carefully executed, leads automatically to the expiring of the warranty! Then the device must be sent back to VIPA for reprogramming

Connector power supply

The Teleservice module is to be power supplied by DC 12 ... 24V ±20%. Here the power consumption amounts to 3 ... 6W.

For power supply there is a 2-pin connector at the upper side of the TM module. The connector is a plug with screw contacts. If connected the plugs may be fixed with screws.

The connector has the following assignment:

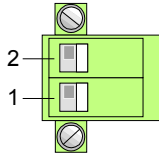

Pin	Name	Meaning
2	12-24V DC	DC 12 ... 24V ±20%
1	GND	Ground power supply

Connector digital I/O

For the digital inputs/outputs there is a connector at the upper side of the Teleservice module. The output is designed as low-side output and may accordingly be configured.

The connector is a plug with screw contacts. If connected the plugs may be fixed with screws.

The I/Os are controlled by *Tags*. An example may be found at the chapter "Deployment" at "Deployment of Tags".

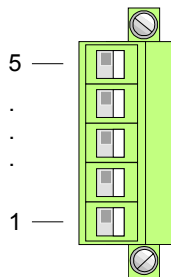

Pin	Name	Meaning
5	DI	Digital input DC 0/24V "0": 0 ... 5V DC "1": 10V ... 30V DC
4	DI_GND	DI ground (isolated)
3	DO_VDC	DO load voltage DC 24V
2	DO	Digital output DC 24V, 0.2A Low-side output
1	DO_GND	DO ground

DI/DO wiring schematic diagram

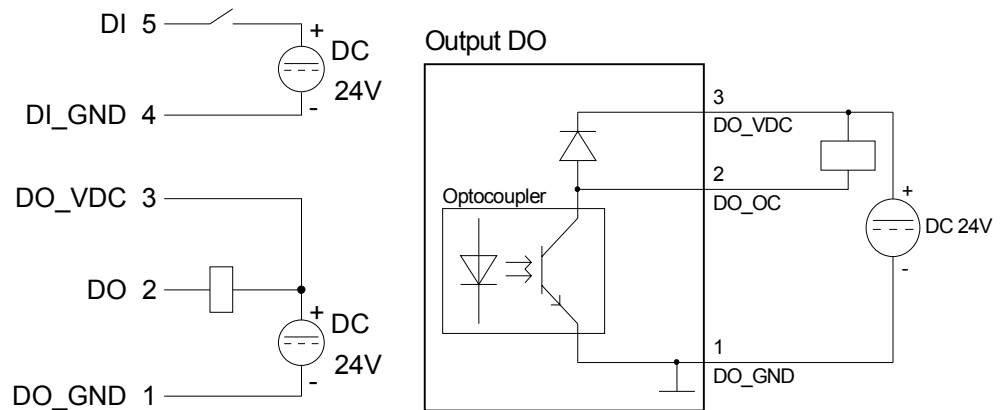

Antenna jack

The Teleservice module has an antenna jack. Here antennas of the type GSM 900MHz / DCS 1800MHz respectively GSM 850MHz / PCS 1900MHz, dual band or quad band may be connected.

The consignment of the TM does not include an antenna. A suited antenna may be ordered by VIPA.

The antenna is provided with a SMA plug. The coaxial built SMA plug (**straight medium adaptor**) is a miniature HF plug with a threaded connector that excels by high HF denseness. In the standard version the plug has a swivel nut with female thread and a pin.

The SMA jack at the TM is with its male thread and the calyx the complement for assembly.

Portable antenna

The portable antenna is a short rod antenna that is mounted without cable directly at the module via the SMA plug.

The antenna may be angled and turned into any direction.

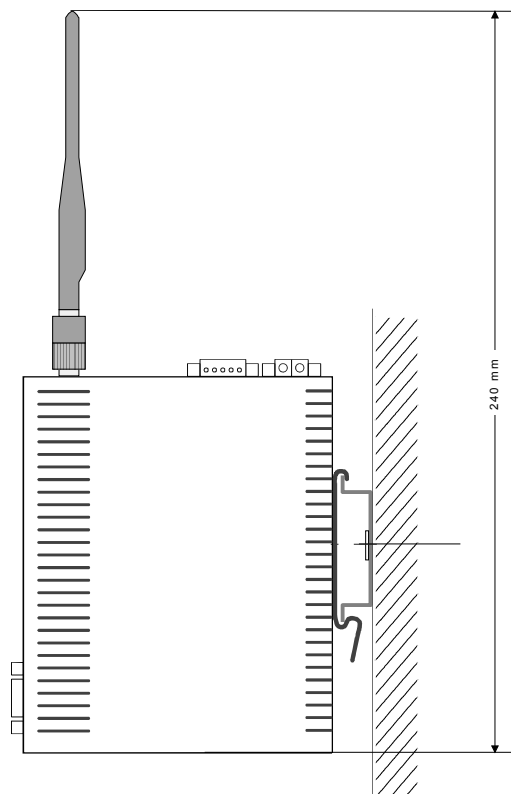
**Slot for the SIM card**

The slot for a cellular mobile telephony SIM card is located at the rear-side of the module.

**Caution!**

Please regard the SIM card may only be plugged if you have configured it at the Teleservice module Web page, before. Else your SIM card may be blocked!

More about the installation of a SIM card may be found in the chapter "Deployment" at "Installation of the SIM card".

Technical Data

TM-E GSM/GPRS Router Quadband

Electrical Data	VIPA 900-2E651
Power supply (rated value)	DC 12 ... 24V \pm 20%
Power consumption	3 ... 6W
Nominal current	max. 300mA
Mark of conformity and certification	CE
Hardware	
Memory	8Mbyte SDRAM, 8Mbyte Flash
Real time clock	Manual setting by Webinterface or automatically by NTP Server, without Battery
Environment conditions	
Position of installation	horizontal/vertical
Operating temperature	0 ... +50°C
Relative humidity	80% (no condensation)
Storage /Transport temperature	-20 up to +60°C
Interfaces	
Ethernet Isolation tested with	RJ45 Ethernet 10/100 BaseTX; 1.5kV
MPI/Profibus-DP	RS485 isolated
Slot for	SIM card
Integrated GSM/GPRS modem	
Bands	Quad band: GSM 900MHz / DCS 1800MHz and GSM 850MHz / PCS 1900MHz
GPS Class	Class 10
Baud rate max.	14.400bit/s
Antenna connector	SMA-F
Digital I/Os	
Input	1xDI 0/24V DC
Output (Low side) Isolation tested with	1xDO DC 24V, 0.2A 3.5kV
Data record	
Protocols	Modbus RS485, Modbus TCP, Unitelway, DF1, PPI MPI (on board) and serial ASCII
Dimensions and weight	
Dimension front (WxHxD)	39 x 129 x 108mm
Weight	300g

Chapter 3 Deployment TM

Overview

This chapter concerns on the deployment of the Teleservice module (TM) from VIPA with a PLC. With the fast introduction you will get an overview about the possibilities of Teleservice. Another part of this chapter is the configuration of the TM module by means of the integrated Web page.

This chapter ends with the possibilities of the teleservice functions.

Content

Topic	Page
Chapter 3 Deployment TM	3-1
Fast introduction.....	3-2
Assembly.....	3-5
Cabling.....	3-6
TM - Configuration - eBuddy	3-7
TM - Reset	3-13
TM - Web page	3-14
TM - PLC linking.....	3-16
TM - Project integration - PG/PC interface via NetPro	3-19
TM - Project integration - PG/PC interface via eVCOM.....	3-24
Installation of the SIM card	3-26
Deployment of Tags	3-28
Teleservice via telephone with MPI gateway	3-31
Teleservice via Callback function	3-35
Teleservice via SMS.....	3-39

Fast introduction

Important note!

The information in this manual should simplify you the deployment of remote controlling VIPA PLCs. More information concerning this may be found in German and English at:

support.ewon.biz
www.ewon-online.de

Power supply

The Teleservice module is to be supplied with DC 12...24V ±20%. The connection is established by a plug. This may be found at the upper side of the module and has the following allocation:

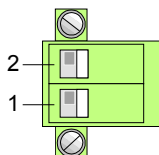

Pin	Name	Meaning
2	12-24V DC	DC 12 ... 24V ±20%
1	GND	Ground power supply

IP address parameters on delivery

For the access to the TM valid IP address parameters are necessary. The IP addresses are assigned by the network administrator and must be coordinated with him.

The TM is delivered with the following IP address parameters:

IP address: 10.0.0.53
Subnet mask: 255.255.255.0

To change the IP address parameters the configuration tool "eBuddy" from VIPA may be used.



Caution!

For every Teleservice module is delivered with the IP address 10.0.0.53 you must not connect more than one new TM module at one time.

First commissioning: Connect the new TM with the network, assign TCP/IP address parameters. Now you may connect the next new TM and so on ...

Linking to Ethernet

Connect your PC to your TM module via Ethernet. Here either a crossed cable or a switch may be used.

An active link via Ethernet is shown by the TM module with the upper green led on the Ethernet interface.

Access via eBuddy

The software tool "eBuddy" may be found at the download area of www.vipa.de. For installation execute eBuddySetup.exe and follow the instructions.

- Start eBuddy.



- Switch to the list view with "Switch to list mode". Here every TM available in you network is listed.

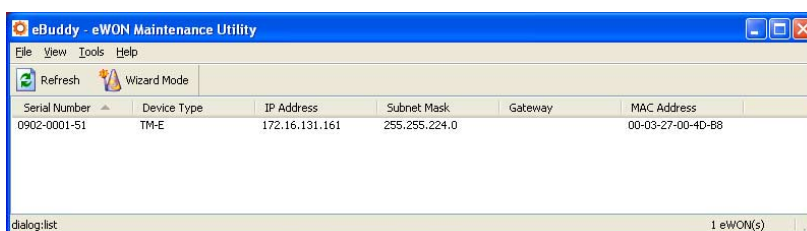

By selecting the corresponding TM at the list, the following functions are available by the context menu (right click):

- Changing respectively entering the IP address parameters
- Loading respectively executing a firmware update
- Backup respectively restoring of an application
- Access to the integrated web page of the Teleservice module

Access to the Web page

Open the Web page of the corresponding TM. After entering *User name* and *Password* the web page of the corresponding TM is opened.

Access parameters

User name: adm
 Password: adm

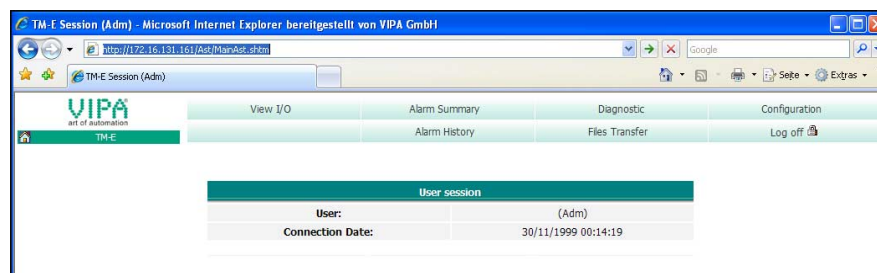

Access to the VIPA PLC

- Connect your CPU to the TM via MPI.
 - Switch on the power supply of the CPU and switch the CPU to RUN.
 - Open the Web page of the corresponding TM.
 - Open with **Configuration** > *I/O server config*. the page for adjusting an I/O server. Set as I/O server "S73&400".
 - To access the VIPA PLC enter the following parameters:

<i>MPI destination node:</i>	2 (standard)
<i>Baud rate:</i>	187500
<i>Reply timeout:</i>	3000 (Standard)
<i>MPI address:</i>	0 (Standard)
<i>Highest MPI station address:</i>	31 (Standard)
<i>Topic A:</i>	enabled
<i>Global device address:</i>	MPI, # (with #: MPI address CPU)
<i>Poll rate:</i>	2000 MS (Standard)
 - To confirm click at [Update config].
- Now the CPU may be accessed via the TM.

Establish a Tag

In a *Tag* the storage areas of you PLC may be defined. These storage areas may R/W accessed by the Tag.

- To establish a Tag open at the Web page the page "Tag setup" and click at "Create new Tag ...".
- Enter the following parameters:

<i>Tag name:</i>	Test
<i>Server name:</i>	S73&400
<i>Topic name:</i>	A
<i>Address:</i>	MW0
<i>Type:</i>	Boolean
- Otherwise leave the standard setting and click at [Add/Update...].
- Switch with **Main menu** > *View I/O* to the Tag list.
- Enter a new value for the Tag "Test" and click at [Update]. Now this value is set and may be transferred to the CPU with clicking to [Update] in the head line.
- If the new value is accepted by the CPU, so the communication between the TM module and the CPU is secured.

**Caution!**

Please regard the SIM card may only be plugged if you have configured it at the TM Web page, before. Else your SIM card may be blocked!

These steps are more described at the following pages.

Assembly

General

The modules are installed on a profile rail. You may use the following standard 35mm profile rail:

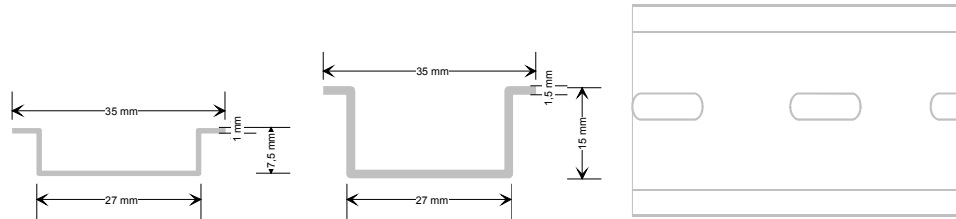

Assembly procedure

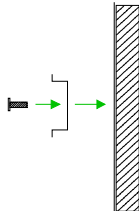

The following sequence represents the assembly procedure as viewed from the side.

- Install the profile rail. Make sure that a clearance of at least 100mm exists above and 70mm below the middle of the profile rail.

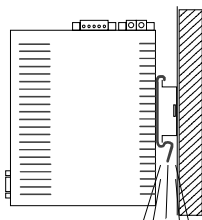
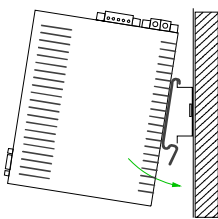
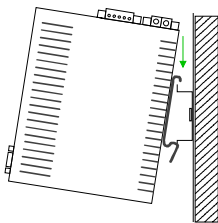

Clack

- Insert the module that you are installing into the profile rail at an angle of about 45 degrees from the top and rotate the module into place until it clicks into the profile rail with an audible click.

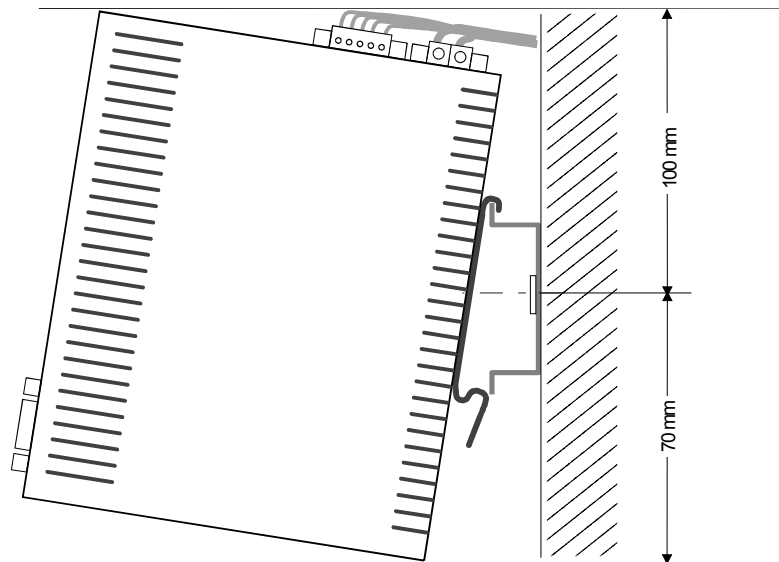

Cabling

Overview

At the upper side of the Teleservice module there are connectors for power supply and digital inputs/outputs. The output is designed as low-side output and may be configured.

The connectors are plugs with screw contacts. If connected the plugs may be fixed with screws.

The I/Os are controlled by *Tags*. An example may be found at the chapter "Deployment" at "Deployment of Tags".

Power supply

The Teleservice module is to be supplied by DC 12...24V ±20%.

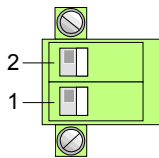

Pin	Name	Meaning
2	12-24V DC	DC 12 ... 24V ±20%
1	GND	Ground power supply

DI/DO connection

The output is designed as low-side output and may be configured.

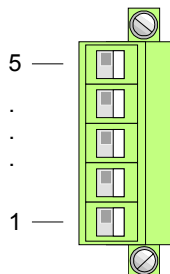

Pin	Name	Meaning
5	DI	Digital input DC 0/24V "0": 0 ... 5V DC "1": 10V ... 30V DC
4	DI_GND	DI ground (isolated)
3	DO_VDC	DO load voltage DC 24V
2	DO	Digital output DC 24V, 0.2A Low-side output
1	DO_GND	DO ground

DI/DO wiring schematic diagram

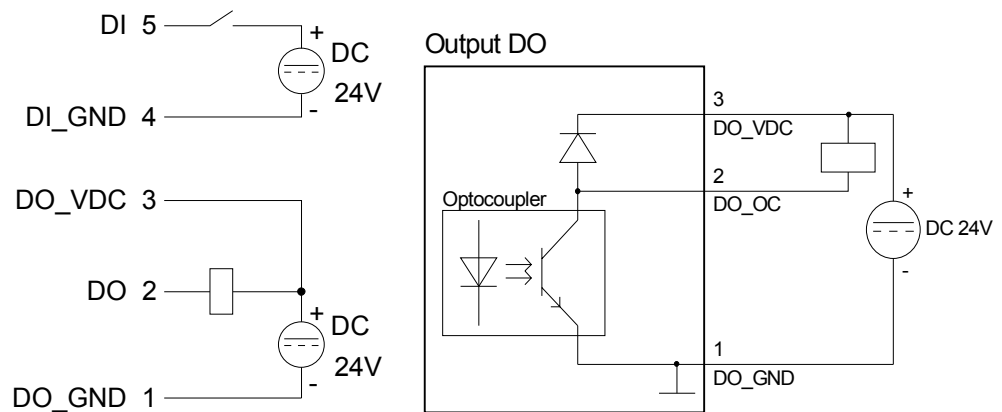

TM - Configuration - eBuddy

Overview

To deploy the Teleservice module, the VIPA software tool "eBuddy" is necessary. With this new IP address parameters may be assigned to the TM; you may load and transfer new firmware, backup/restore applications and access the integrated web page of the TM.

Installation

The software tool "eBuddy" may be found at the download area of www.vipa.de. For installation execute eBuddySetup.exe and follow the instructions.

Wizard mode List mode

Connect the Teleservice module via Ethernet and switch on its power supply. Start eBuddy. This always starts in the last used mode.



Wizard mode

Here the following functions are available:

- Set or modify the IP address parameters
- Load or execute a firmware update
- Backup or restore of an application

List mode

To change to the *List mode* from the *Wizard Mode* click to the link "Switch to list mode". In the *List mode* every TM module available in you network is listed.

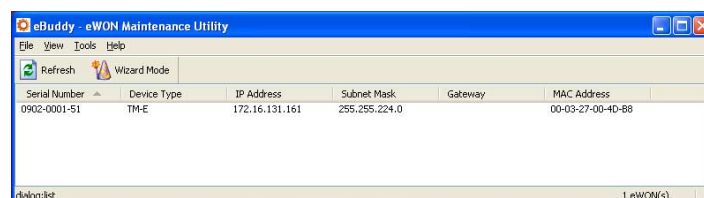

By selecting the corresponding TM in the list, there are the same functions available by context menu (right click), which were listed above.

Additionally the Web page integrated to the Teleservice module may directly be accessed by "Open in browser"

**Basics
IP address
and subnet**

Industrial Ethernet exclusively supports IPv4. At IPv4 the IP address is a 32Bit address that must be unique within the network and consists of 4 numbers that are separated by a dot.

Every IP address is a combination of a **Net-ID** and a **Host-ID** and its structure is as follows: **XXX.XXX.XXX.XXX**

Range: 000.000.000.000 to 255.255.255.255

The network administrator also defines IP addresses.

**Net-ID
Host-ID**

The **Network-ID** identifies a network res. a network controller that administrates the network.

The Host-ID marks the network connections of a participant (host) to this network.

Subnet mask

The Host-ID can be further divided into a **Subnet-ID** and a *new Host-ID* by using a bit for bit AND assignment with the **Subnet mask**.

The area of the original Host-ID that is overwritten by 1 of the Subnet mask becomes the Subnet-ID, the rest is the new Host-ID.

Subnet mask	binary all "1"		binary all "0"
IPv4 address	Net-ID	Host-ID	
Subnet mask and IPv4 address	Net-ID	Subnet-ID	<i>new Host-ID</i>

Subnet

A TCP-based communication via point-to-point, hub or switch connection is only possible between stations with identical Network-ID and Subnet-ID! Different area must be connected with a router.

The subnet mask allows you to sort the resources following your needs. This means e.g. that every department gets an own subnet and thus does not interfere another department.

Address at first start-up

At the first start-up the TM has the following IP address:

IP address: 10.0.0.53
Subnet mask: 255.255.255.0



Attention!

For every Teleservice module is delivered with the IP address 10.0.0.53 you must not connect more than one new Teleservice module at one time. First commissioning: Connect the new TM with the network, assign TCP/IP address parameters. Now you may connect the next new TM and so on ...

Address classes

For IPv4 addresses there are five address formats (class A to class E) that are all of a length of 4byte = 32bit.

Class A	0	Network-ID (1+7bit)	Host-ID (24bit)
Class B	10	Network-ID (2+14bit)	Host-ID (16bit)
Class C	110	Network-ID (3+21bit)	Host-ID (8bit)
Class D	1110	Multicast group	
Class E	11110	Reserved	

The classes A, B and C are used for individual addresses, class D for multicast addresses and class E is reserved for special purposes.

The address formats of the 3 classes A, B, C are only differing in the length of Network-ID and Host-ID.

Private IP networks

To build up private IP-Networks within the Internet, RFC1597/1918 reserves the following address areas:

Network class	Start IP	End IP	Standard subnet mask
A	10. <u>0.0.0</u>	10. <u>255.255.255</u>	255.0.0.0
B	172.16. <u>0.0</u>	172.31. <u>255.255</u>	255.255.0.0
C	192.168.0. <u>0</u>	192.168.255. <u>255</u>	255.255.255.0

(The Host-ID is underlined.)

These addresses can be used as net-ID by several organizations without causing conflicts, for these IP addresses are neither assigned in the Internet nor are routed in the Internet.

Reserved Host-IDs

Some Host-IDs are reserved for special purposes.

Host-ID = 0	Identifier of this network, reserved!
Host-ID = maximum (binary complete 1)	Broadcast address of this network

**Note!**

Never choose an IP address with Host-ID=0 or Host-ID=maximum!

(e.g. for class B with subnet mask = 255.255.0.0, the "172.16.0.0" is reserved and the "172.16.255.255" is occupied as local broadcast address for this network.)

Changing the IP address

For the access to the Teleservice module valid IP address parameters are necessary. The IP addresses are assigned by the network administrator.

Per default the Teleservice module is delivered with the IP address 10.0.0.53. You may switch to the IP address parameter wizard with "Set IP address".

By clicking to [Browse...] each TM of the network is listed.

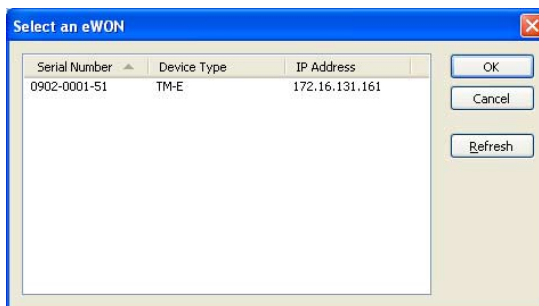

- Choose the TM, which corresponds to the serial number. Confirm your input and click to [Continue >].
- The dialog window to enter IP address data is opened.
- Enter the new IP address parameters. By clicking to [Continue >] the new IP address parameters are transferred to the TM.
→ The TM module is started new. After a certain waiting period and during successful transmissions this is reported.
- [Finish >] closes the dialog.

Symbolic name instead of IP address

With each new dial-in of the Teleservice module, this is assigned automatically with a new IP address. This is called dynamic address allocation.

Usually the TM sends an eMail containing the current valid IP address. By this IP address the TM may be accessed.

With the service of a DNS service provider like e.g. www.no-ip.com there is the possibility to directly access the TM by a name instead by the IP address.

Here usually a free user account is to be established.

The corresponding DNS service provider may be selected on the Web page of the TM at "Networking config" with the page "Publish IP address". Here the user data may be entered.

During communication the dynamic IP address is submitted to the service provider and there transformed to the symbolic name.

Update firmware

A firmware update happens in 2 steps:

- Update eBuddy
- Update firmware

Update eBuddy

With "Update eBuddy" the firmware files may directly be stored at you PC. This is necessary to update the firmware of you TM.

As source the Internet or a local directory may be selected. With [Continue >] the available firmware language versions are listed. Select the corresponding version and download it with [Continue >] to your PC.

Update firmware

With "Update firmware" a dialog window is opened to request the login data. By selecting the corresponding TM and by entering the login data, the firmware versions at your PC and at the Teleservice module are listed.

Choose the concerning firmware version at your PC. The update procedure is started by [Continue >].

**Attention!**

When installing a new firmware you have to be extremely careful. Under certain circumstances you may destroy the TM, for example if the voltage supply is interrupted during transfer or if the firmware file is defective. In this case, please call the VIPA-Hotline!

The proceeding of the update is shown as a proceeding bar. Wait here until the bar is at 100%.

A successful update is reported by a status report.

Backup / restore application

With this function the configuration of a Teleservice module may be stored and uploaded to the TM module.

Each modification on the configuration of the TM should be stored.

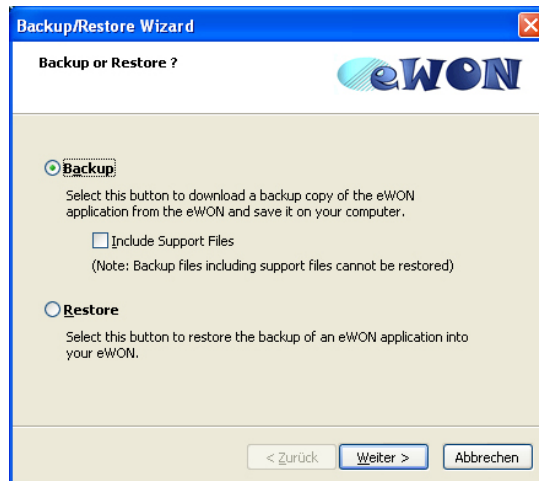

Backup

Open the dialog window with clicking to "Backup/restore application". Select "Backup". Even if you want to forward the backup to the VIPA support the files relevant to the support should also be saved. Here activate the option "Include support files". Click to [Continue >].

Select the corresponding Teleservice module, enter your login data and click to [Continue >]. Navigate to the concerning directory and enter a file name.

With [Continue >] the backup is stored with the file name in the concerning directory.

The proceeding of the write procedure is shown as a proceeding bar. Wait here until the bar is at 100%.

As soon as the backup is finished, you get a feedback.

Restore

Open the dialog window with clicking to "Backup/restore application". Select "Restore" and click to [Continue >].

Select the corresponding TM, enter your login data and click to [Continue >]. Navigate to the concerning directory and enter a file name of the backup.

With [Continue >] the data are transferred to the TM.

The proceeding of the write procedure is shown as a proceeding bar. Wait here until the bar is at 100%.

As soon as the restore is finished, you get a feedback.

TM - Reset

Overview

At the front-side of the Teleservice module there is a Reset button. This may be located below the LEDs and may be operated by a pointed object.

With the Reset (*user reset*) extra created Web pages and Tag configurations are erased. Here the communication settings are still remaining.

For a *complete reset* please contact the VIPA support.



Caution!

An unauthorized *complete reset*, which possibly was not carefully executed, leads automatically to the expiring of the warranty!

Then the device must be sent back to VIPA for reprogramming.

User-Reset

There is the following proceeding for the *user reset*:

- Switch-off the Teleservice module.
- Press the Reset button.
- Switch-on the Teleservice module and leave the reset button pressed as long as the "USER"-LED is blinking red.
- Release the Reset button now.

Now the Teleservice module executes a restart. Wait until the "USER"-LED blinks green.

TM - Web page

Access to the Web page

- Start the VIPA configuration tool "eBuddy".
- Switch to the list view with "Switch to list mode". Here every TM available in your network is listed.

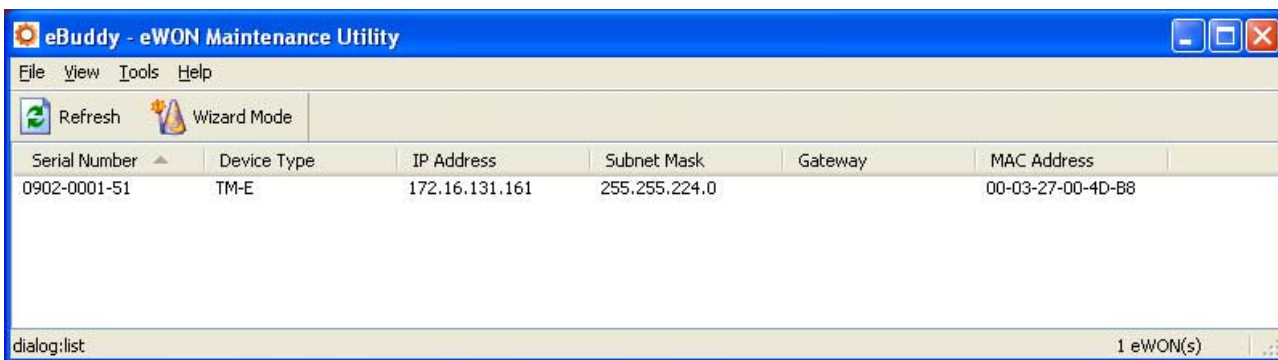

- Click to the concerning TM and select in the context menu "Open in browser". Your Web browser is opened with the request of *User name* and *Password*.
Per default the TM is delivered with the following user data:

User name: adm
Password: adm

After entering *User name* and *Password* the web page of the corresponding Teleservice module is opened.



Structure	The functionalities of your Teleservice module are separated to the areas <i>Main menu</i> and <i>Configuration</i> with the following structure.
Main menu	Each information of the Teleservice module may be accessed by the Main menu. The Information are separated to the following pages:
View I/O	Shows a list of the configured Tags. Here PLC value may be preset and evaluated.
Alarm Summary	At this page the current alarms are listed. Here the alarms may be acknowledged.
Alarm History	Here each alarm and history arte listed.
Diagnostic	This page serves several possibilities for diagnostics of the TM module by means of sub pages.
File transfer	Here each information may be downloaded from the Teleservice module as lists.
Configuration	Every setting of the Teleservice module may be established by this page. Here the main functionalities are separated to the following pages:
Tag Setup	Here Tags may be configured, which were listed at "View I/O" and may be controlled there.
System Setup	Via this page the basic parameters of the Teleservice module may be accessed. Depending on the functionality these are assigned to the pages General (general settings, net services and diagnosis), Communication (Interfaces and network) and Storage (administration storage memory).
IO Server Config	There are pre-defined servers for several communication protocols and systems inside the Teleservice module. By selecting the corresponding server this may be configured.
Script Setup	To expand the functionalities, scripts may be programmed by means of a BASIC language. Scripts may be transferred and maintained by this page.
User Setup	Here users may be applied and administrated.
Pages List	To increase the structure, Tags may be assigned to several pages. The administration of these pages happens by this page.

TM - PLC linking

Preconditions For the further approach there is condition your Teleservice module has valid IP address parameters and the Web page of the TM may be accessed.

Connect VIPA PLC via MPI To get access to the VIPA PLC, the VIPA CPU is to be connected to the MPI jack of the Teleservice module via a suited MPI cable.
 If there is an Ethernet CP within your PLC, for TM access you may connect it to Ethernet instead to MPI.
 Switch-on the power supply of the CPU and switch the CPU to RUN.

Configure VIPA PLC in TM

- Open the concerning Web page of the Teleservice module. Now you are requested for access parameters.
 Per default the TM has the following access parameters:

Access parameters

User name: adm
 Password: adm

- After entering of *User name* and *Password* the Web page of the Teleservice module is opened.



- Open with **Configuration** > *IO Server Config* the page to preset I/O server.

I/O server configuration

- For the VIPA PLC select as I/O server "S73&400".
The following dialog window is opened:

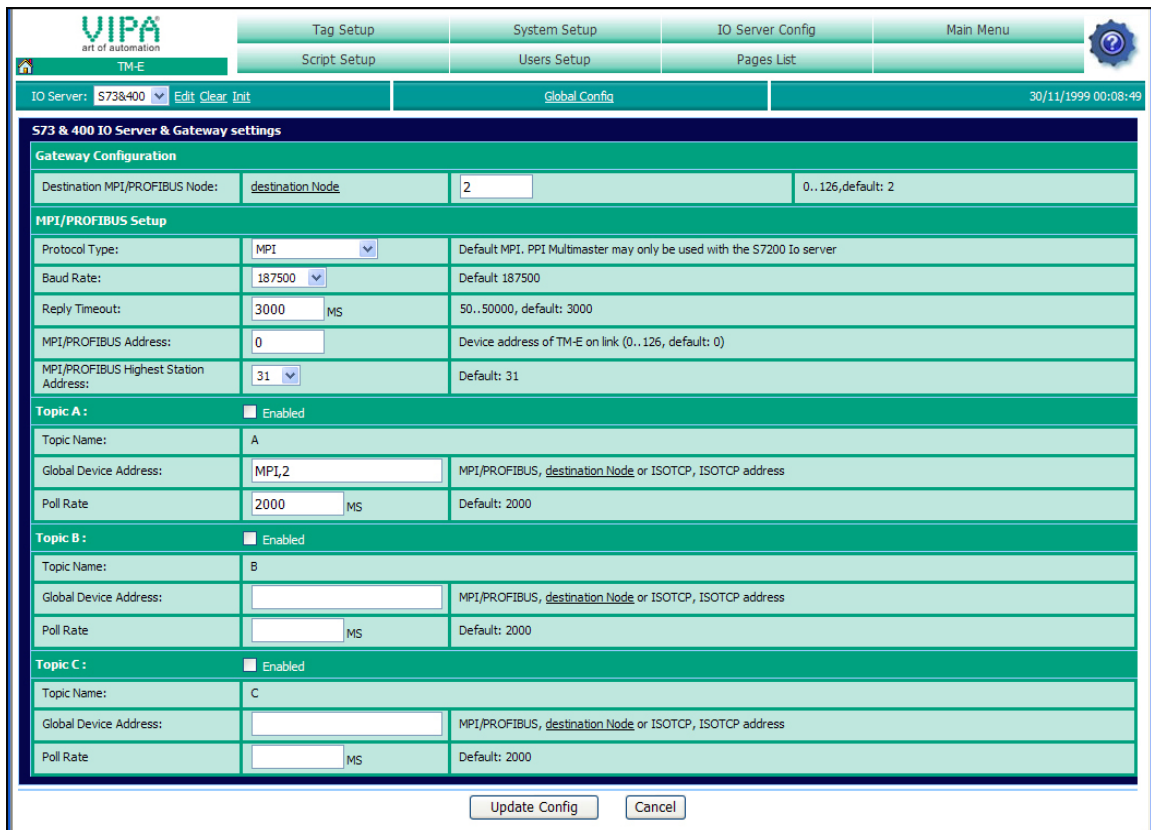

At "Gateway Configuration" and "MPI/Profibus Setup" the values are preset, which are to be used per default.

- Destination node (Address of the destination node)
- Protocol type (standard: MPI)
- Baud rate (standard: 187500)
- Reply Timeout (standard: 3000ms)
- MPI/Profibus Address (Address of the TM module, standard: 0)
- Highest MPI/Profibus Address (standard: 31)

At *Topic ...* access paths to your PLC may be defined, assigned to a corresponding *Topic* character and activated.

By presetting the key words MPI, PROFIBUS respectively ISOTCP and adding an address, a corresponding access path may be defined.

Access via Profibus: PROFIBUS, # (with # corresponds to the Profibus address of your connected PLC)
Example: PROFIBUS, 5

Access via MPI: MPI, # (with # corresponds to the MPI address of your PLC)
Example: MPI, 2

Access via IP address: ISOTCP,IP address,00.02
Enter each without spaces and always add to the IP address ",00.02".
Example: ISOTCP,192.16.167.123,00.02

Enter at *Poll Rate* the standard value 2000ms and click at [Update config].

Test PLC connection

To test the MPI connection a *Tag* is to be created. In a *Tag* memory areas of you PLC are defined.

These storage areas may R/W accessed by the *Tag*.

- To establish a Tag open at the Web page the page "Tag setup" and click at "Create new Tag ...".
- Enter the following parameters:
Tag name: Test
Server name: S73&400
Topic name: A
Address: MW0
Type: Boolean
- Otherwise leave the standard setting and click at [Add/Update...].

Access via View I/O

- Switch with **Main menu** > *View I/O* to the Tag list.
- Enter a new value for the Tag "Test" and click at [Update]. Now this value is set and may be transferred to the CPU with clicking to [Update] in the headline.

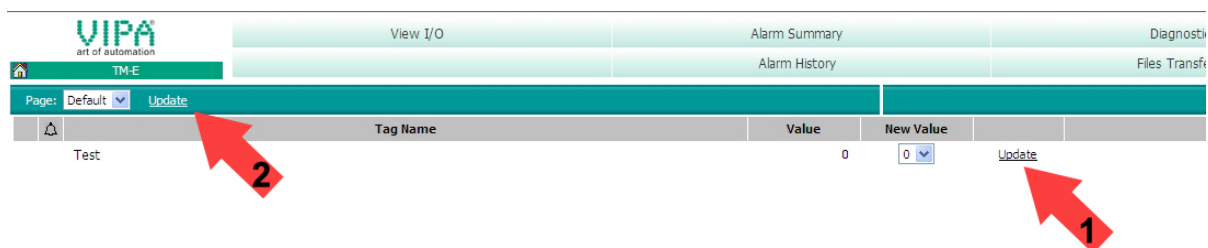

- If the new value is accepted by the CPU, so the communication between the TM and the CPU is secured.

TM - Project integration - PG/PC interface via NetPro

- Precondition** For the further approach it is precondition that you have access to the Web page of the Teleservice module and your CPU is connected to the Teleservice module via MPI and is accordingly configured (see "TM - PLC linking").
- For the project engineering, a thorough knowledge of the Siemens SIMATIC manager the hardware configurator and NetPro is required.
- IP address and subnet mask of your PC are known.
- Teleservice** With the teleservice the Teleservice module works as gateway. As gateway via the served communication connections you have access to the VIPA PLC, which is connected via MPI to the TM.
- So that the TM can work as gateway, you have to integrate this to your hardware configuration.
- Load TM-E.cfg station file** For the deployment of the Teleservice module in the Siemens SIMATIC manager, the installation of the station file TM-E.cfg is necessary.
- This file may be found in the download area at www.vipa.de.
- Download this file to your PC. Later this file is to be imported to the PG/PC interface.
- De-activate the automatic IP address assignment** Since in the Teleservice module predefined IP address data for the PPP server are used, in your project you have to de-activate the automatic address assignment.
- Start the Siemens SIMATIC manager with your project. Your project should contain your CPU, which is connected via MPI to the MPI bus.
 - Open via **Options** > Set *PG/PC interface* the properties dialog.
 - Select the interface parameter assignment "TCP/IP(Auto)...", which corresponds to your network card and click to [Properties].
 - Select the Register "IE-PG Access" and activate the parameter "Do not assign IP address automatically".
 - Confirm your setting with [OK].

Integrate the TM to the Siemens SIMATIC manager

The integration of the Teleservice module to your project happens as PG/PC interface. After the configuration this may be defined as access path for the PLC functions.

The configuration happens with the following approach:

- Start the software NetPro, by clicking to .

For example you see the following structure:

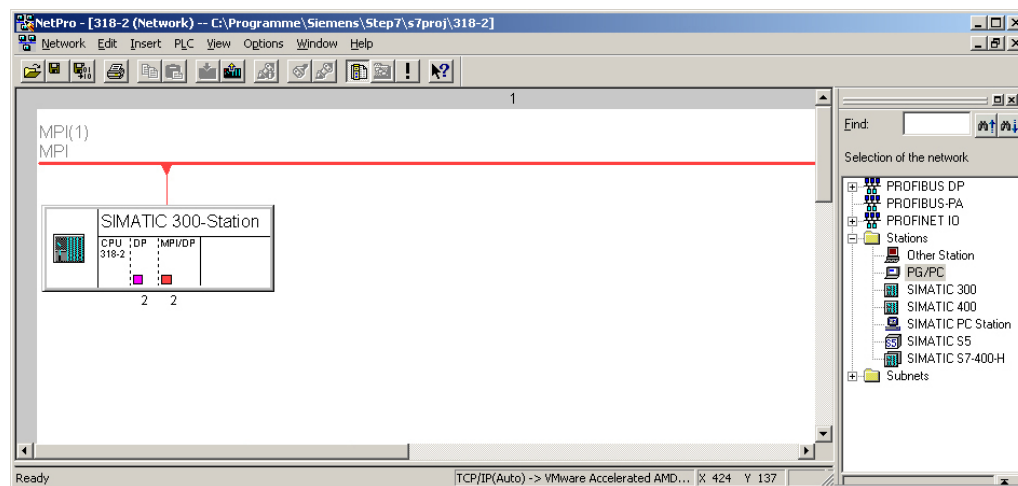

Add PG/PC station

- Add the station "PG/PC" from *Network*, by double-clicking to the station "PG/PC".

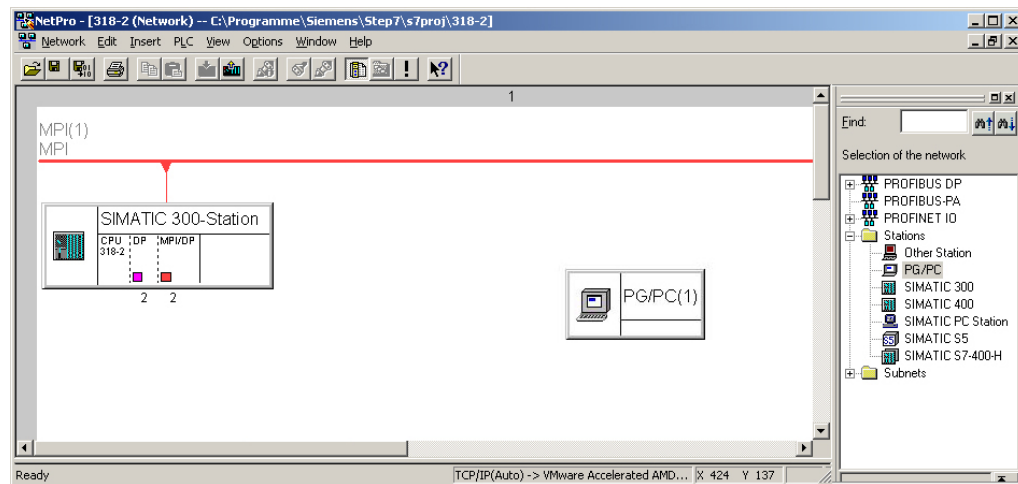

Properties
PG/PC station

- Open the properties of the PG/PC station.
- Access the register "Interfaces" and click to [New...].
- Select the type "Industrial Ethernet" and click to [OK].
- De-activate "Set MAC address..."
- Enter at "IP address" and "Subnet mask" the IP address parameters of you PC determined before.

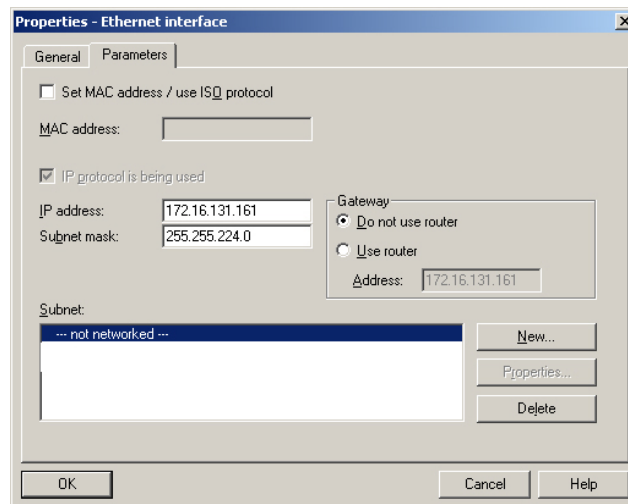

- To establish a new subnet click at [New...].
- Confirm the properties with [OK].
- Select if not happened the new established subnet and click at [OK]. Now you are back in the properties dialog.
- Call the register "Assignment".
- Highlight at "Configured Interfaces" your Ethernet interface and select at "Interface parameter assignments in the PG/PC" the parameter, which starts with "TCP/IP(Auto) ->..." and corresponds to your network card.
- Click at [Assign].

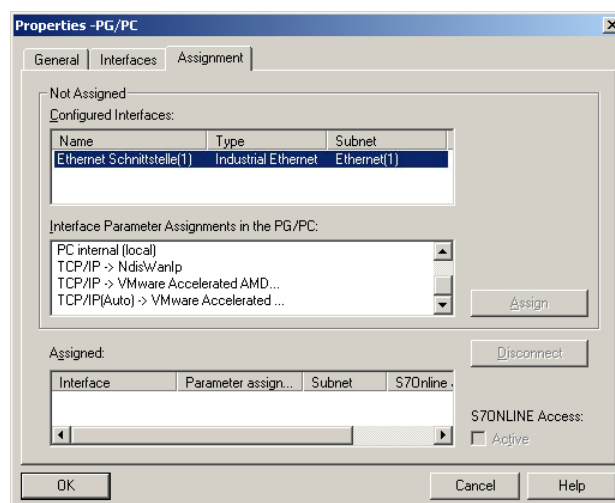

- Ignore the warn messages and close the "properties" dialog with [OK].

Now your graphical net view should show the following structure:

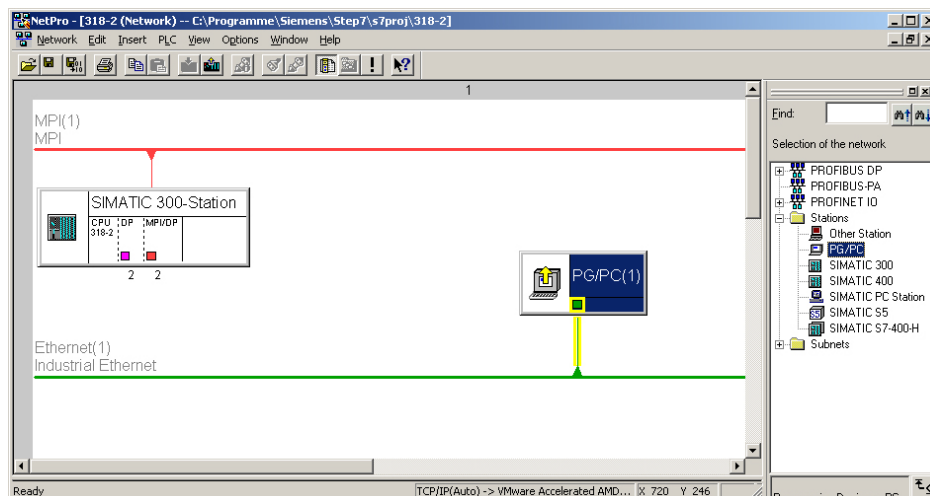

Import the TM via station file

To import the Teleservice module to your project the first downloaded station file is necessary.

- Start in NetPro the import via **Edit > Import**.
- Activate the parameter "Export file of a station".
- Enter path and name of the station file TM-E.cfg and click to [OK]. Possibly appearing warnings may be ignored by [Close].

Now your graphical net view should show the following structure:

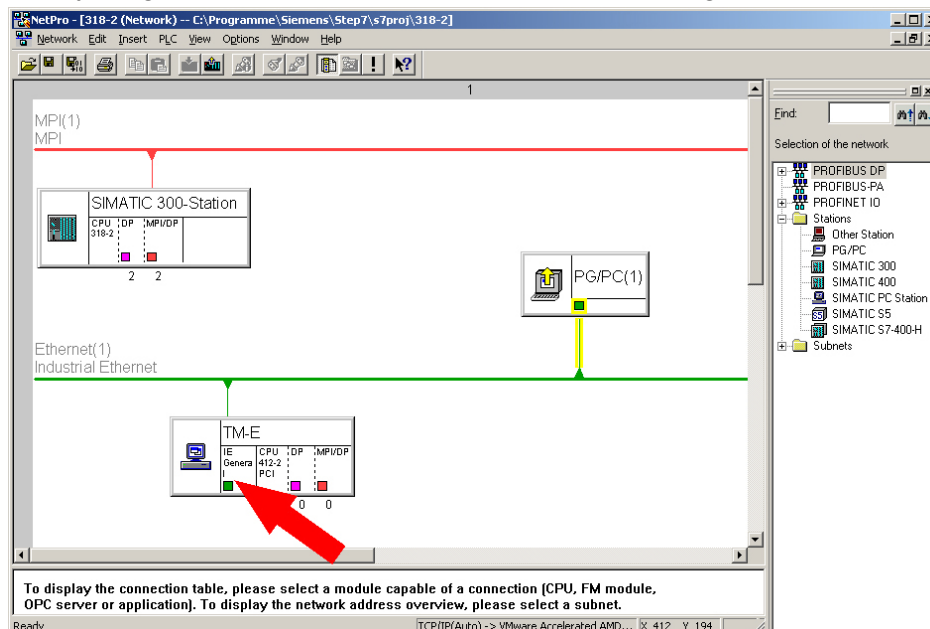

- Open the properties dialog of the communication component "IE General" of the station "TM-E".
- Click in the area "Interface" at [Properties...]. A dialog window for IP address data settings is opened.

Define access via IP address

Depending on the access modes to your Teleservice module, there are the following possibilities to preset IP address parameters:

Access via Ethernet

Enter here IP address and subnet mask of your TM. The IP address parameters must correspond to the IP address parameters, which were preset with the software tool "eBuddy".

Access via PPP connection

If you want to access your TM via dial connection (PPP connection), the following preset IP address parameters are to be used:

IP address: 202.0.0.240
 Subnet mask: 255.255.255.0

Set the MPI address

Open the properties dialog of the communication component "MPI/DP" of "TM-E". Enter the MPI address. This must correspond to the MPI address preset by the software tool "eBuddy".

NetPro should now show the following structure.

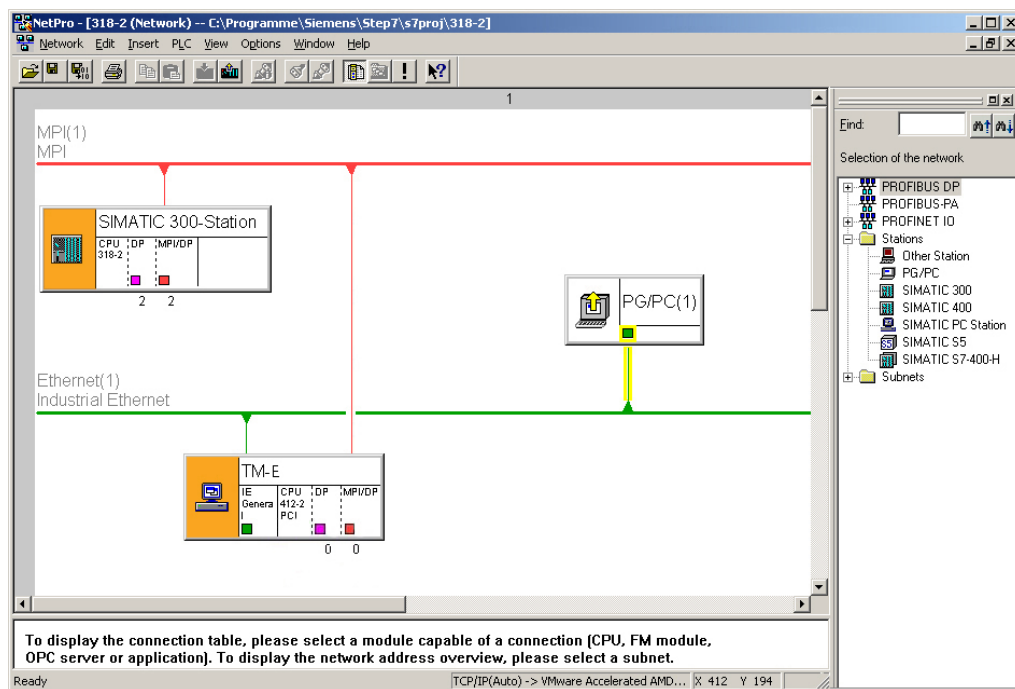

Transfer the project to the CPU

Click in the graphical net view at the CPU and transfer your project with **Download > Selected stations**.

Now your CPU may be accessed via this connection from the Siemens SIMATIC manager.

TM - Project integration - PG/PC interface via eVCOM

Overview

As another version here the project integration is to be shown by means of a virtual MPI interface. To do this on the PC side the driver "eVCOM" from VIPA is to be installed. Contrary to "Project integration via NetPro" no adjustment is necessary on the PLC side. This version is easy to use but slower than "Project integration via NetPro".

With this functionality HMI devices may be accessed, which were configured via MPI.

With the teleservice the Teleservice module works as gateway. As gateway via the served communication connections you have access to the PLC, which is connected via MPI to the TM.

Precondition

For the further approach it is precondition that you have access to the Web page of the Teleservice module and your CPU respectively your HMI device is connected to the Teleservice module via MPI and is accordingly configured (see "TM - PLC linking").

Installation

The driver file "eVCOM" may be found in the download area www.vipa.de. For installation start eVCOMSetup.exe and follow the instructions.

Establish virtual interface

- Start eVCOM.
- In the Dialog window click at [Add Port]
- Select a free COM port of your PC and choose "MPI ISO TCP" for MPI communication.

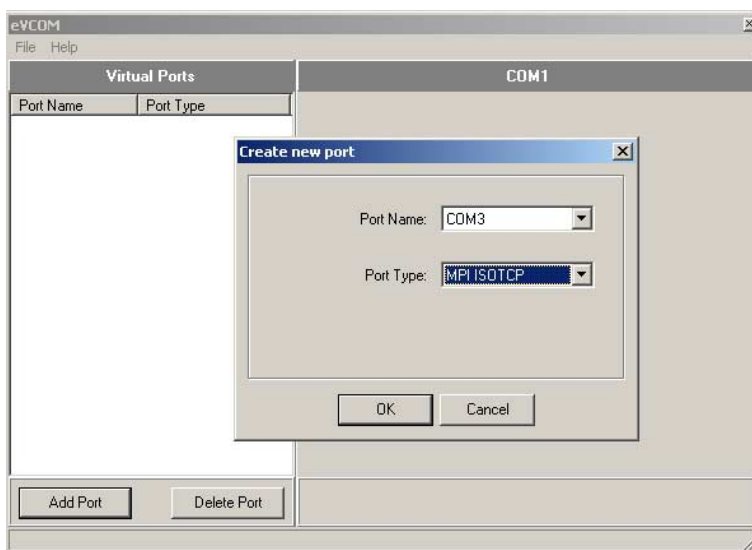

- Confirm your settings with [OK].
- Enter at *Gateway address* a valid IP address (see below).
- Do not change the *Gateway port* "102".
- Confirm you settings and click at [Enable Port]. The virtual MPI interface is now activated. This is shown by the symbol  in the list.

Define access via IP address

Depending on the access mode to your Teleservice module, there are the following possibilities to preset the IP address:

Access via Ethernet

The IP address must be the same as the IP address, which was preset by the software tool "eBuddy".

Access via PPP connection

If you want to access your TM via dial connection (PPP connection), the IP address 202.0.0.240 is to be used.

Settings in the Siemens SIMATIC Manager

- Load your project in the SIMATIC manager from Siemens.
- Choose in the menu **Options** > *Set PG/PC interface*.
- Select in the according list the "PC Adapter (MPI)"; if appropriate you have to add it first, the click at [Properties].
- Switch to the register *MPI*.
- Set the transfer parameters of your MPI net and type in an unused address.
- Switch to the register *Local connection*.
- Select the COM port, which you have configured at eVCOM and set the transfer rate to 38400baud. Confirm you settings with [OK]. Now your CPU may be accessed with the TM via MPI by means of the PLC functions.

Installation of the SIM card



Caution!

Please regard the SIM card may only be plugged if you have configured it at the TM Web page, before. Else your SIM card may be blocked!

Preconditions

For the further approach it is precondition that you have access to the Web page of the TM and you have a valid GSM SIM card with PIN.

Configuration at the Web page

- Open the Web page of the Teleservice module.
- Navigate via **Configuration** > *System setup* to the page "Communication".
- Open at the navigation tree **Interfaces** the page "Modem".
- At "GSM PIN" type in the pin number, which is delivered with your SIM card. Leave every values at default setting and click at [Update].

Installing the SIM card

The slot for the SIM card is located at the rear-side of the module. The SIM card should be installed before the assembly. The installation happens with the following approach:

- Switch off the power supply of the Teleservice module.
- Insert the SIM card as shown to the SIM card slot. Please regard here the correct positioning!

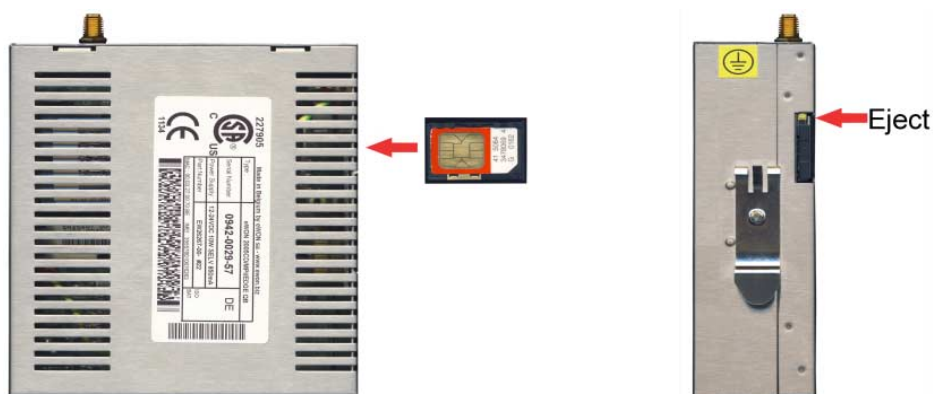

- For taking the SIM cart push the eject button with a pointed object. The eject button may be found above the card slot.

Commissioning with SIM card

- Connect if not just happened a suited antenna. The Teleservice module has a an antenna jack. Here a GSM dual band antenna may be connected. The TM is delivered without any antenna. You may get a suited antenna from VIPA.
You find the order numbers in this manual under "Properties".
- Switch-on again the power supply of the TM. With a cold restart it may last up to 2 minutes until the GSM modem is been rebooted and initialized.
- Open the Web page of the Teleservice module.
- Navigate via **Configuration** > *System setup* to the page "Communication".
- Open in the navigation tree **Interfaces** the page "Modem".

If you have made everything correctly and your GSM modem is connected to a mobile network, the following parameters are listed:

Modem detected	This parameter shows you the type of the internal modem. Here the text "internal Multiband GSM" should be shown.
Signal level	Here the signal level 0...99 is shown. This value is determined once a minute. For a communication connection this value should be higher than 17. A value of 25 corresponds to a good connection. If a value is higher than 30 this correspond to an excellent connection. A signal level of 0 indicates a non existing mobile network.
Network	"Home Network" is shown if the SIM card is operated in the country of which the SIM card is from. If the Teleservice module is operated in an other country, "Roaming" is shown. Otherwise the following error messages may be displayed with his parameter: - "SIM card error!" if SIM card is missing - "PIN code error!" if PIN is faulty - "in operation..." the modem tries to connect to a mobile network.
Operator	Here the name of your mobile network provider is listed.

Deployment of Tags

Precondition For the further approach it is precondition that you have access to the Web page of the Teleservice module, your PLC may be reached via the TM and the corresponding *Topics* are configured. The access paths to your PLC are defined by *Topics*. More about the configuration of *Topics* may be found at "TM - PLC linking".

What is a Tag? A *Tag* is a digital respectively analog value, which is assigned to a data source. For example the data source could be a flag word of your PLC. To a Tag you have reading and writing access (configurable). So the directly assigned data source may be accessed by the Tag.
By presetting of limit values for a Tag, the TM has the possibility for limit monitoring and appropriate alerting via SMS respectively eMail.

- Establishing a Tag**
- Open the Web page of the TM to establish a Tag.
 - Navigate via **Configuration** > *Tag setup* to the page "Create New Tag....".
 - Here the following parameters may be entered:

Identification

- Tag name:* Name with which the Tag is listed. The Tag name may maximally consist of 64 characters and must not include the following characters:
space, \$ "
- Page:* Let the value at "Standard"
- Tag description:* Give a comment to the Tag

I/O server setup

- Server name:* For VIPA PLCs select "S73&400"
- Topic name:* Devices within an I/O server are grouped by *Topic name*.
Enter A, if you have defined your MPI interface as Topic A, as described at "TM-E - PLC linking".
- Address:* Enter a value from your PLC, which is to be assigned to the Topic (see the following table).
- Type:* Here define as Type *boolean* or *analog* depending on the parameter *Address*.

Alarm setup

If you wish an alerting, you may enter limit values here for alert messages.

Name conventions for Address

The following symbolic names may be used on deployment together with a VIPA PLC by selecting "S73&400" server:

Symbol

Symbol	Memory type	Modifier	Address
DBx	Data block with No. x	B, C, W, S, D, L, F	Byte offset
M	Internal memory (flag)	B, C, W, S, D, L, F	Byte offset
C	Counter	W, S	Counter No.
T	Timer	W, S	Timer No.
I	Process inputs	B, C, W, S, D, L, F	Byte offset
Q	Process outputs	B, C, W, S, D, L, F	Byte offset
PI	Peripheral inputs	B, C, W, S, D, L, F	Byte offset
PQ	Peripheral outputs	B, C, W, S, D, L, F	Byte offset

Modifier

Modifier	Type	Range of values
B	Byte	0 ... 255
C	Byte with sign	-128 ... 127
W	Word	0 ... 65535 (default)
S	Word with sign	-32768 ... 32767
D	DWord	0 ... 4294967296
L	DWord with sign	-2147483648 ... 2147483647
F	Float	+/- 3.4E38

Bit access via

With each memory type there is the possibility to access a bit. Here add a # and the bit no. to the *Address* name.

For the bit no. the values 0 ... 7 may be used.

**Note!**

If you do not enter a *Modifier* automatically the type "Word" is used. With data blocks a *Modifier* is always to be entered.

Example

Address	Description
MW4	Flag word 4
CS1	Counter 1, read as word with sign
TS7	Timer 7, read as word with sign
DB2L5	DWord at address 5 (in bytes) in data block 2
IB3	Byte at address 3 (in bytes) in the input area
I5#2	Input I5.2
Q10#6	Output Q10.6

Examples

For the further approach it is precondition that you have access to the Web page of the Teleservice module, your PLC may be reached via the TM and the corresponding *Topics* are configured.

Accessing data in the PLC

- Open the Web page of the Teleservice module.
- Navigate via **Configuration** > *Tag setup* to the page "Create new Tag ...".
- Enter the following parameters:

<i>Tag name:</i>	Test
<i>Server name:</i>	S73&400
<i>Topic name:</i>	A
<i>Address:</i>	MW0
<i>Type:</i>	Boolean
- Otherwise leave the standard setting and click at [Add/Update...].

Access via View I/O

- Switch with **Main menu** > *View I/O* to the Tag list.
- Enter a new value for the Tag "Test" and click at [Update]. Now this value is set and may be transferred to the CPU with clicking to [Update] in the headline.

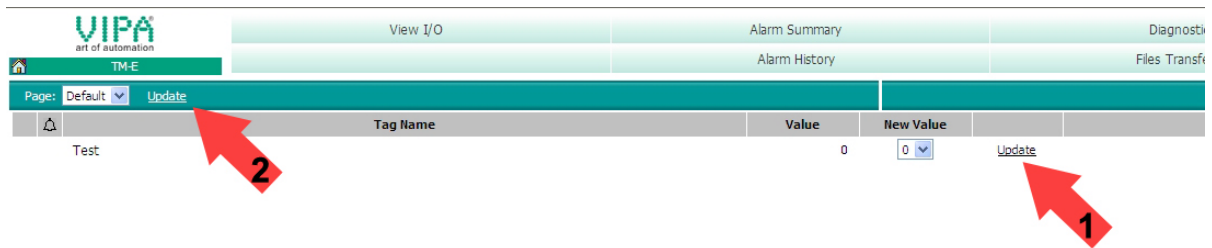

- If the new value is accepted by the CPU, so the communication between the TM and the CPU is secured.

Accessing the I/Os of the TM

- Open the Web page of the Teleservice module.
- Navigate via **Configuration** > *Tag setup* to the page "Create new Tag ...".
- Enter the following parameters:

<i>Tag Name:</i>	TM_Input	res.	TM_Output
<i>Server Name:</i>	TM		TM
<i>Topic Name:</i>	<i>remains free</i>		<i>remains free</i>
<i>Adresse:</i>	DI1		DO1
<i>Typ:</i>	Digital		Digital
- Otherwise leave the standard setting and click at [Add/Update...].

Access via View I/O

Here also the input may be read respectively the output may be written by means of the Tag list.

Teleservice via telephone with MPI gateway

Overview

With the teleservice via telephone with MPI gateway, a connection via telephone (PPP connection) is directly established from your PC to the TM. Here the CPU is linked to the Teleservice module by MPI.

To be able to react to the calling, to authenticate the user and to assign the IP address, the TM is to be configured as PPP server.

The following picture shows the network topology on an example:

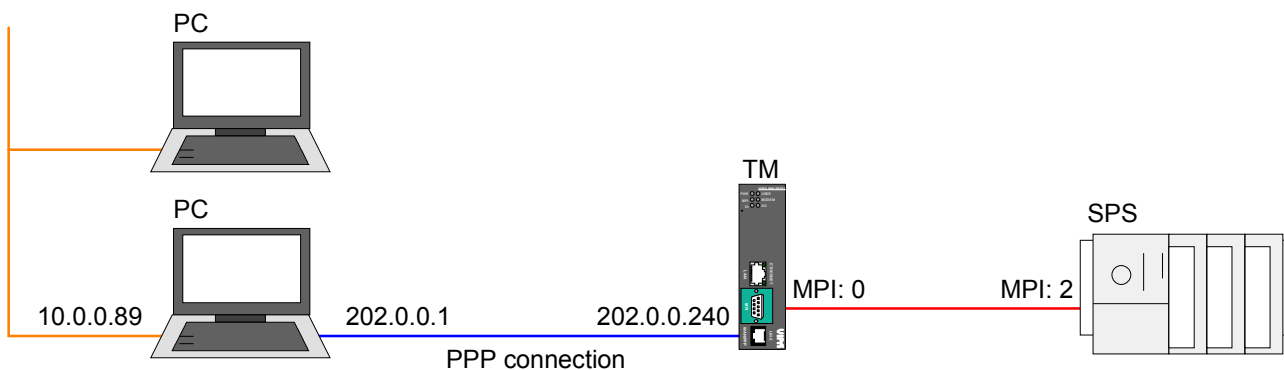

In the configuration above there are 2 various networks:

- 10.0.0.0 is the network of your PC.
- 202.0.0.0 is the temporary network, which is to be used for the PPP connection. This network is only active during PPP connection.

Precondition

For the further proceeding it is precondition you have access to the Web page of the Teleservice module and your CPU is connected to the TM module via MPI and accordingly configured.

Further it is precondition that a SIM card installed and your TM module is connected to the mobile network.

Configuration of the direct telephone connection

To access the Teleservice module via PPP connection the server for incoming PPP connections is to be configured.

- Here open the Web page of the Teleservice module.
- Navigate to the "Communication" page via **Configuration** > *System setup*. Open the page "Incoming" in the navigation tree **Network Connection** > *Modem*.
- Activate the option "Server enabled".

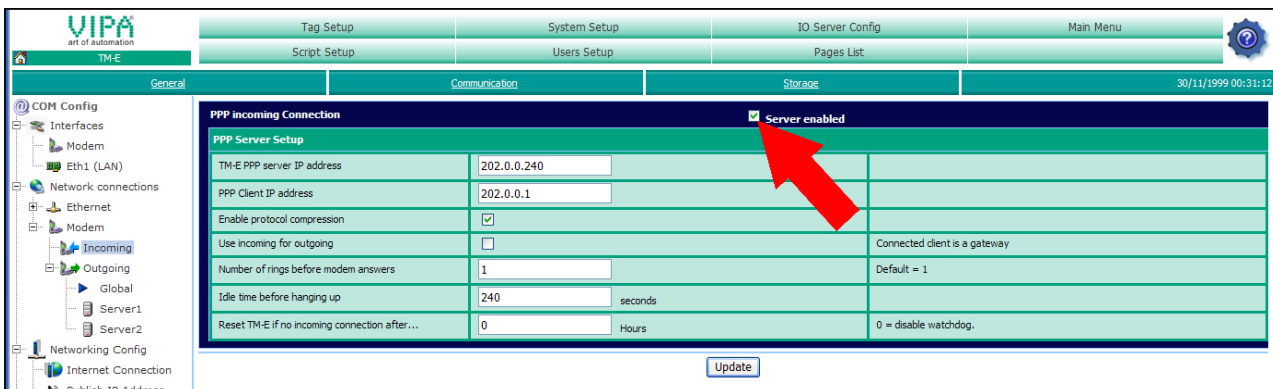

- Here enter the following parameters:
 - "TM-E PPP server IP address": 202.0.0.240
 - "PPP client IP address": 202.0.0.1
- Accept the remaining default settings and click at [Update].

Configure your PC modem so that it may establish a connection to the TM module. Here establish a DFÜ connection. More about this may be found in the manual of your PC operating system.

Here please regard that User name and Password are identical to the access data in you Teleservice module.

Test the telephone connection

Call your Teleservice module via the PC modem. Open as soon as the TM reacts a DOS command window and send a ping to the IP address 202.0.0.240. You should now get a response. Else check your settings.

Configure routing in PLC project

Information how to integrate your TM to your PLC may be found at "TM - Project integration - PG/PC interface".
If you have just integrated your TM into your PLC project, at the TM station of NetPro the routing is accordingly be adapted.

- Open NetPro with your project.

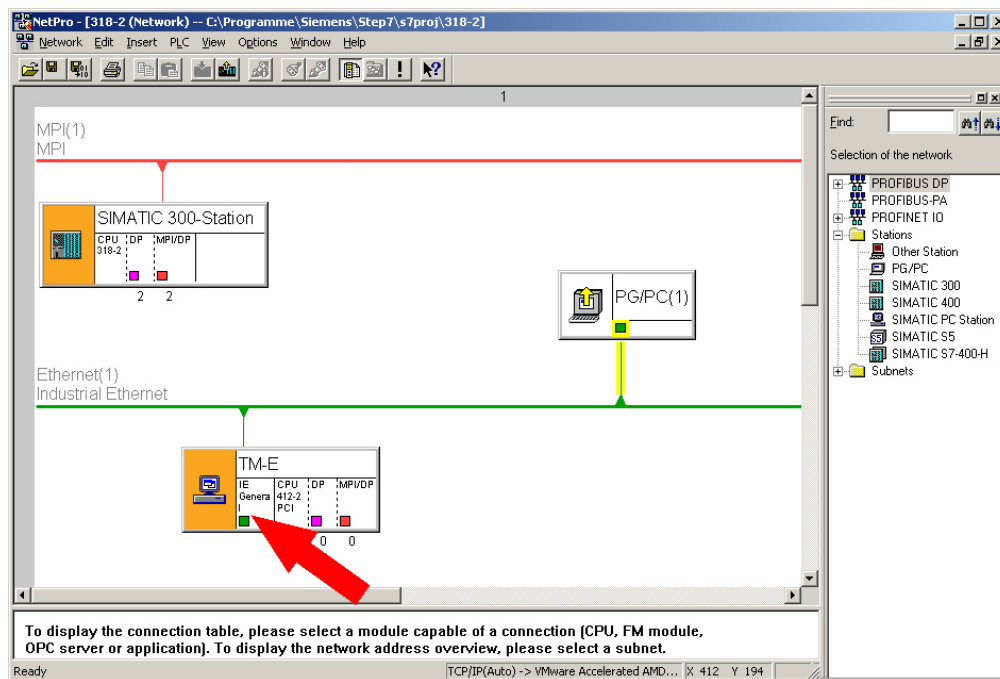

- Open the properties dialog of the communication component "IE General" of the station "TM-E".
- Click at "Interface" at [Properties]. A dialog window for presetting the IP address data is opened.

Access defined by IP address

For the access via PPP dial connection the following predefined IP address data are to be used:

IP address: 202.0.0.240
Subnet mask: 255.255.255.0

Set MPI address

Open the properties dialog of the communication component "MPI/DP" of "TM-E". Enter the MPI address. This must be the same as the MPI address configured with the software tool "eBuddy".
Please regard that your CPU is connected via MPI and the MPI address is accordingly assigned. VIPA CPUs are delivered with MPI address 2.

NetPro should now show the following structure.

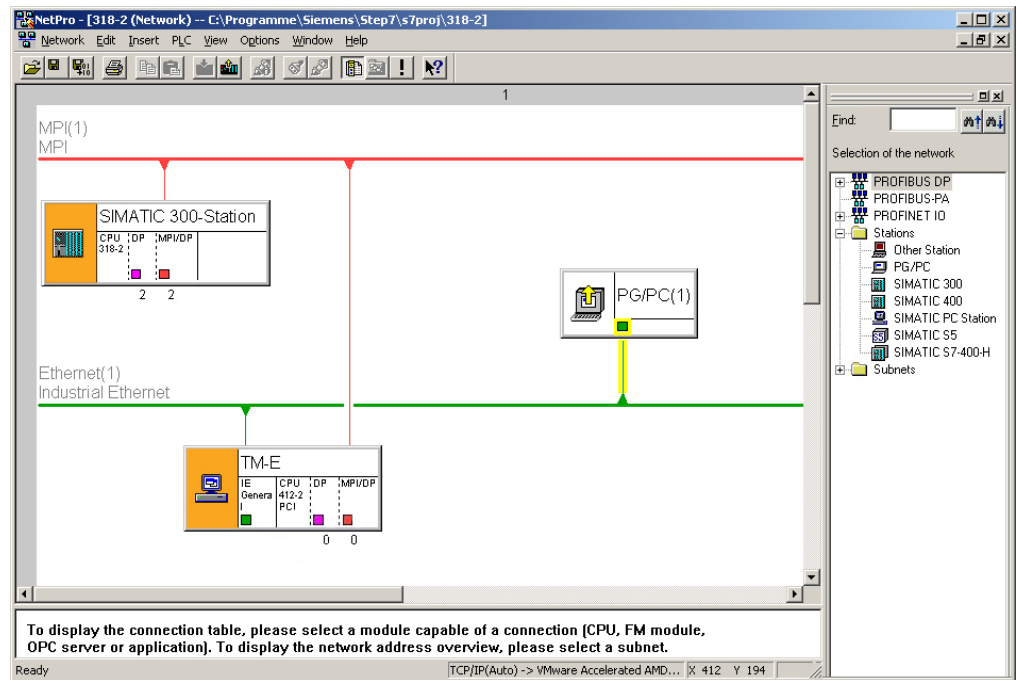

Transfer the project to the CPU

Click in the graphical net view at the CPU and transfer your project with **Download > Selected stations**.

Teleservice via Callback function

Overview

With Callback there is the possibility to call the Teleservice module with a defined number of ring signals to initiate the callback mode.

Now the module accesses the Internet and sends an eMail, which contains in its text a dynamic PPP IP address. This address may be accessed as long as the TM module is online. So you may save money for connection, if e.g. the plant to be observed is abroad.

The configuration of the Callback mode happens on the Web page of the TM module with the following approach:

- Configuration of the direct telephone connection
- Configuration of the dial-up server
- Configuration of the mail server
- Activation of the Callback

Precondition

For the further proceeding it is precondition you have access to the Web page of the TM and your CPU is connected to the TM module and accordingly configured.

Further it is precondition that a SIM card installed and your TM is connected to the mobile network.

Configuration of the direct telephone connection

If you have just established the Teleservice via telephone, please continue with the configuration of the dial-up server.

With the Teleservice via telephone a connection via telephone (PPP connection) is directly established from your PC to the TM.

To be able to react to the calling, to authenticate the user and to assign the IP address, the TM is to be configured as PPP server.

The following picture shows the network topology on an example:

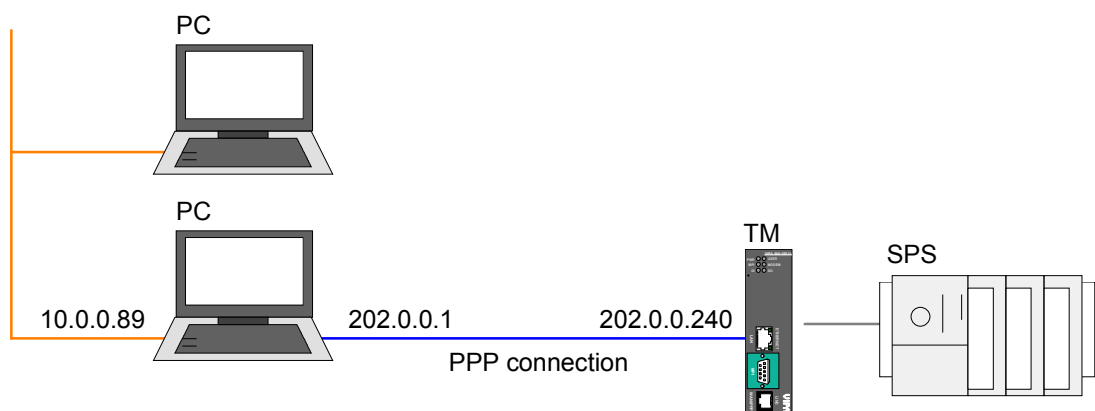

In the configuration above there are 2 various networks:

- 10.0.0.0 is the network of your PC.
- 202.0.0.0 is the temporary network, which is to be used for the PPP connection. This network is only active during PPP connection.

Configuration

To access the TM via PPP connection the server for incoming PPP connections is to be configured.

- Here open the Web page of the Teleservice module.
- Navigate to the "Communication" page via **Configuration** > *System setup*. Open the page "Incoming" in the navigation tree **Network Connection** > *Modem*.
- Activate the option "Server enabled".

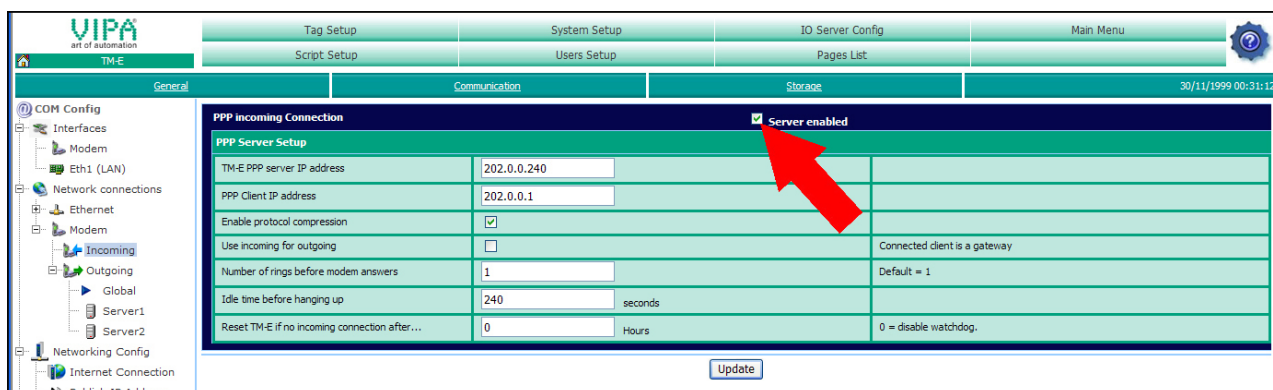

- Here enter the following parameters:
 - "TM-E PPP server IP address": 202.0.0.240
 - "PPP client IP address": 202.0.0.1
- Accept the remaining default settings and click at [Update].

Configure your PC modem so that it may establish a connection to the TM. Here establish a DFÜ connection. More about this may be found in the manual of your PC operating system.

Here please regard that User name and Password are identical to the access data in you TM.

The default access parameters are:

User name: adm
 Password: adm

Test the telephone connection

Call your Teleservice module via the PC modem. Open as soon as the TM reacts a DOS command window and send a ping to the IP address 202.0.0.240. You should now get a response. Else check your settings.

Configuration of the dial-up server

Activate the dial-up server for the dial-up to the Internet.

- Here open the Web page of the TM.
- Navigate via **Configuration** > *System setup* to the page "Communication". Open at the navigation tree **Network connection** > *Modem* > *Outgoing* the page "Global".
- Activate the option "PPP outgoing connection parameters".

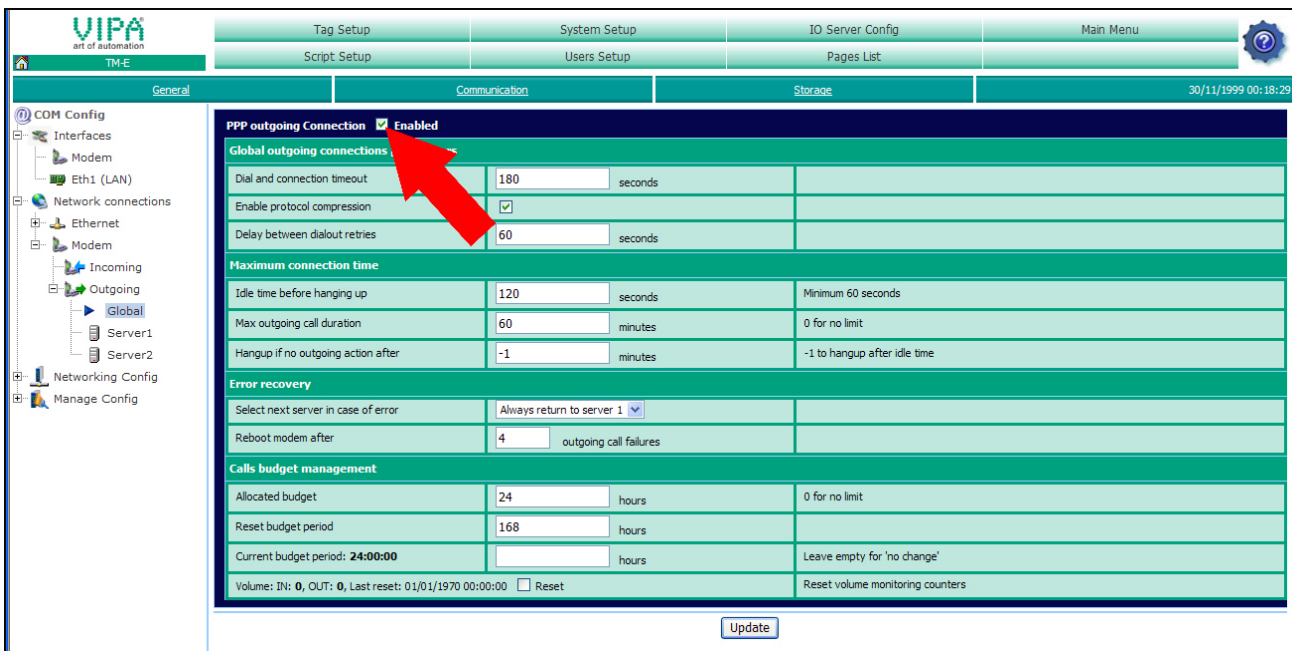

- Leave every value at default setting and click at [Update].
- Click at "Server1".

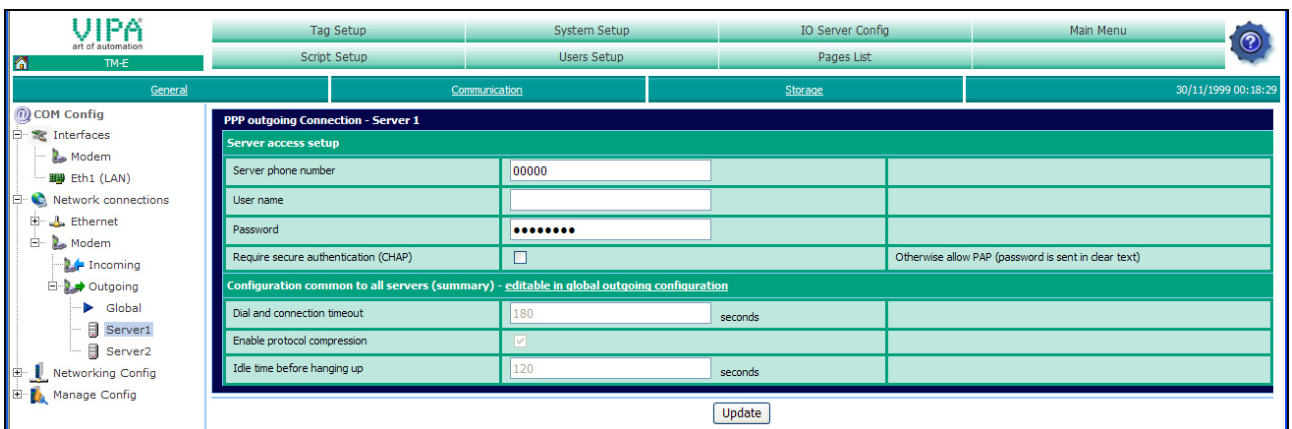

- For the dial-up via modem enter *Server phone number*, *User name* and *Password* and click at [Update].

Configuration of the mail server

- To enter the SMTP server open the page "General" at "System setup".
- Navigate at the navigation tree to **Net Services > SMTP (mails)**.

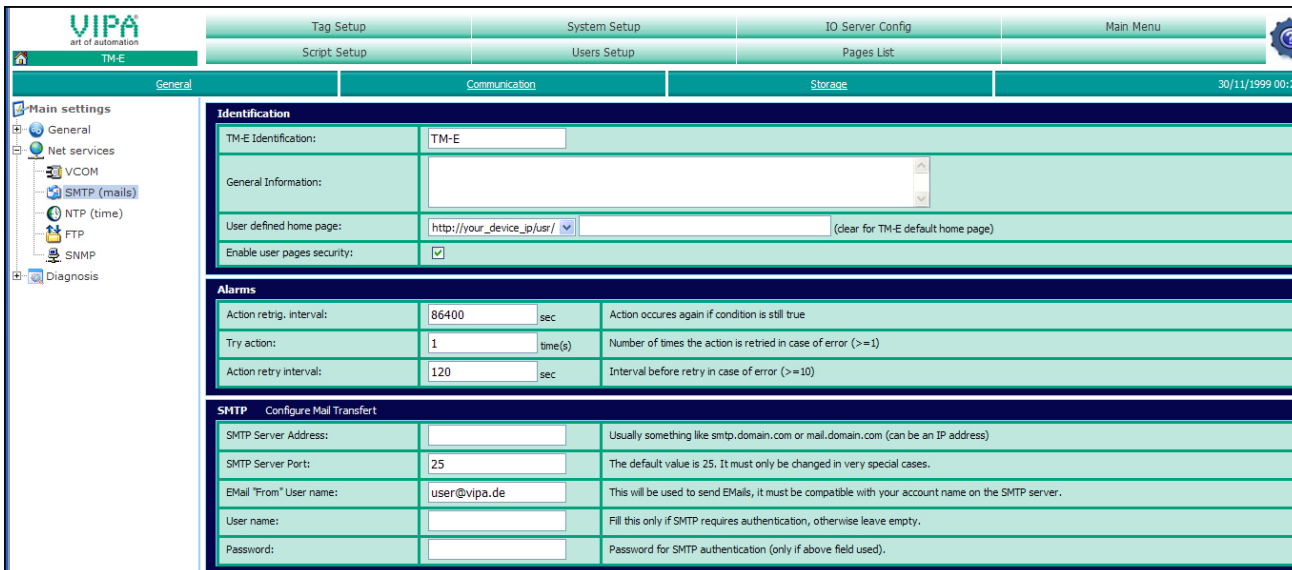

- Here enter the following parameters:
 - SMTP server address (may be an IP address or a domain)
 - SMTP server port (default: 25)
 - eMail address (valid eMail address)
 - *User name* and *Password* may only be entered if secure authentication was activated in the dial-up server configuration.

Activation of the Callback

- To activate the Callback open the page "Communication" at "System setup".
- Navigate in the navigation tree to **Network Config > Callback**.

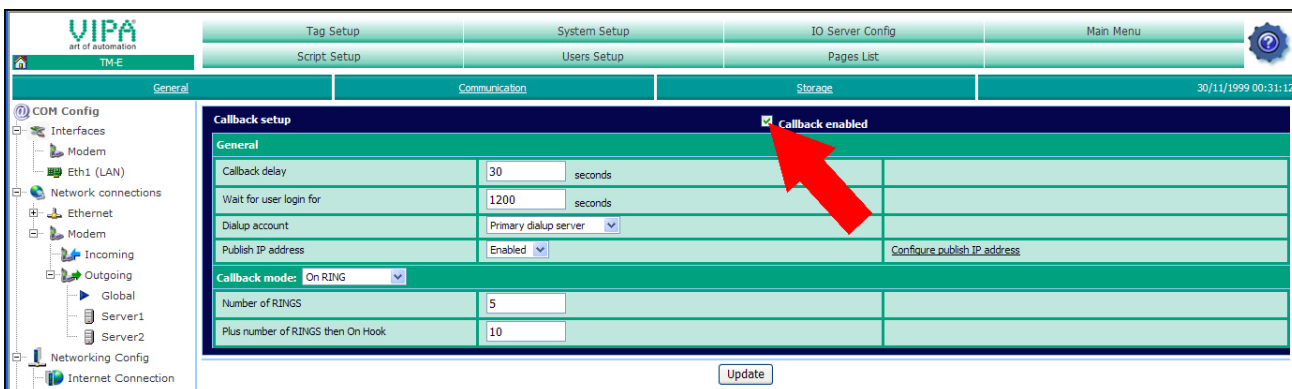

- Activate the option "Callback enabled".
- Accept the default settings and click at [Update].

Test the Callback

For a test call the telephone number of your TM. Let it ring 5 times and then disconnect. After about 30 seconds the TM attempts now to dial-up to the Internet to establish a connection to the mail server to send you an eMail. The eMail contains an IP address. The TM may now be accessed by this address.

Teleservice via SMS

Overview

With the Teleservice module with GSM modem there is the possibility to remote control your connected PLC.

Here a script language with a syntax similar to BASIC is used.

In this part we cannot nearly describe the programming instructions. More information about this script language may be found in the programming guide in German and English at:

support.ewon.biz

www.ewon-online.de

This Teleservice module from VIPA is constructed in the same way as the module "eWON2001".

Precondition

For the further proceeding it is precondition you have access to the Web page of the TM module and your CPU is connected to the TM via MPI and accordingly configured.

Further it is precondition that a SIM card installed and your TM is connected to the mobile network.

Creating a script

- To create a script open the Web page of the TM.
- Open with **Configuration > Script setup** the "Script Section".
The following dialog window is opened:

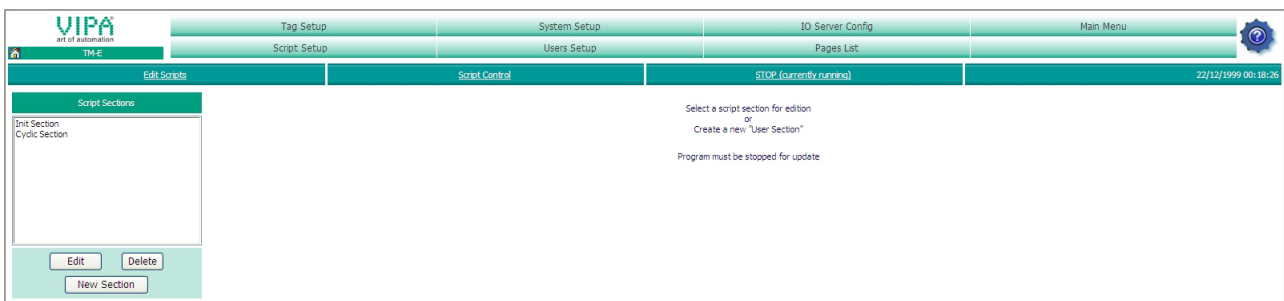

Here the scripts may be programmed and administrated. Per default there are the scripts "Init Section" and "Cyclic Section", which are empty.

The script processing should always be stopped with [STOP (currently running)], before a script is been created respectively edited.

With [RUN (currently stopped)] the scripts processing may be started again after editing.

Example

At the following pages you may find scripts for the following applications:

- Reboot TM via SMS
- Acknowledge alarm via SMS
- Request an eMail report via SMS

Reboot TM via SMS

- Open the Web page of the TM.
- Navigate to "Script setup".
- To be able to use the SMS services you have to create the scripts "SMS" and "Restart". For this click at [New section].

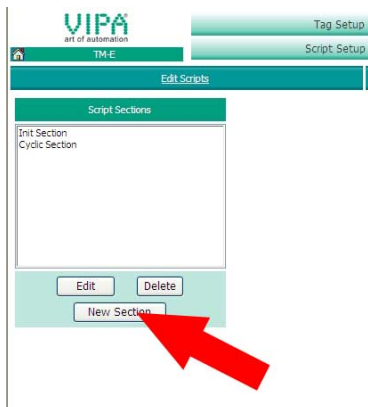

- Enter "SMS" at *Script Name* and click at [Update].
- Click at [New section].
- Enter "Restart" and click at [Update]. The new created scripts are now listed in the Script list.
- Select in the list the script "SMS" and click at [Edit].
- In the dialog window type in the following programming code:

```

SMS :
a%=Getsys Prg,"SmsRead"
If(a%<>0) Then
  s%=s%+1
  PRINT "SMS Nr: ";s%
  f%=Getsys Prg,"smsfrom"
  Print"From: ";f%
  Print Getsys Prg,"smsdate"
  a%=Getsys Prg,"smsmsg"
  Print "Message: ";a%
  b%=f%+" ,gsm,0"
  If(a%="Reboot") THEN
    c%="Received message: "+a%
    d%="Reboot is started in 1 min."
    Sendsms b%,d%
    ONTIMER 1, "goto restart"
  Else
    e%="Wrong instruction"
    Sendsms b%,e%
  Endif
  Goto SMS
Endif
End

```

- Activating the script
- To confirm the script click at [Update]. Please regard that the script processing is in state "RUN (currently stopped)". Otherwise you will get an error message.
 - Enter the following into the "Restart" script:

```
Restart :  
REBOOT
```

- Confirm with [Update]. Please also regard that the script processing is just stopped.
- So that your TM is able to execute the "SMS" script when prompted by SMS, the following lines are to added to the "Init Section":

```
ONSMS "Goto SMS "  
TSET 1,60
```

With ONSMS the SMS surveillance is started. TSET 1,60 starts Timer 1 , which executes the "Restart" script after 60s as defined in the "SMS" script.

- Confirm with [Update].
- Click at [RUN (currently stopped)] to start the script processing.

Test reboot via SMS

Send a SMS with *Reboot* to the telephone number of the GSM card of the TM. Now you will get a confirmation SMS with the following text:
Reboot is started in 1 min.

Within one minute the TM is rebooted, which you may see at the reaction of the LEDs.

Acknowledge alarm via SMS

For example you may monitor the following values of your VIPA PLC:
DB 1, Byte 13, Bit 3

Establishing an alarm Tag

- For this open the Web page of the Teleservice module.
- To establish an alarm Tag open the page "Create new tag..." via **Configuration** > *Tag setup*.
- Enter here the following parameters:

Identification

Tag name: Alarm1
Page: Default
Tag description: Comment

I/O server setup

Server name: S73&400
Topic name: A
Address: DB1B13#3
Type: boolean

Alarm setup

Alarm enabled: enable option
Boolean alarm level: set to 1

- Leave the other values on its default setting, enable the option "Then edit notification" and click at [Add/Update only].

The dialog window "Alarm notification ..." is opened

- Enter the following parameters:

SMS upon: enable the option ALM
SMS designation: here type in the telephone number with the following structure: number,gsm,0
Enter each without spaces and always add to telephone number ",gsm,0".
SMS subject: please type in the following text:
"Alarm 1: Error message - please confirm with A1".

- Click at [Update].

Script for alarm
acknowledge
via SMS

To be able to react to a confirmation SMS, a script at your TM is necessary. The configuration of the script happens with the following approach:

- Navigate to **Configuration** > *Script settings*.
- Stop if not just happened the script processing with [STOP (currently started)].
- Click at [New section], type in as script name "A1_Quit" and enter the following programming code:

```
A1_Quit:
a%=Getsys Prg,"SmsRead"
If(a%<>0) Then
  s%=s%+1
  PRINT "SMS Nr: ";s%
  f$=Getsys Prg,"smsfrom"
  Print"From: ";f$
  Print Getsys Prg,"smsdate"
  a$=Getsys Prg,"smsmsg"
  Print "Message: ";a$
  b$=f$+",gsm,0"
  If(a$="A1") THEN
    c$="Received message: "+a$
    d$="Alarm1 was confirmed"
    Sendsms b$,d$
    ALMACK "Alarm1", ""
  Else
    e$="Wrong instruction"
    Sendsms b$,e$
  Endif
  Goto A1_Quit
Endif
End
```

Activating the script

- To confirm the script click at [Update].
- So that your TM module is able to execute the "A1_Quit" script when prompted by SMS, the following lines are to added to the "Init Section":

```
ONSMS "Goto A1_Quit"
```

- Confirm with [Update].
- Click at [RUN (currently stopped)] to start the script processing.

Test alarm acknowledge via SMS

To release a test SMS you have to release an alarm.

- For this open the Main menu of the TM Web page and click at "View I/O". Here you will find the new created Tag "Alarm1".
- To release an alarm set the "New value" to 1.
- Click at "Update". The new value is set. This releases an alarm due to the alarm settings and is indicated by the alarm symbol 🚨.

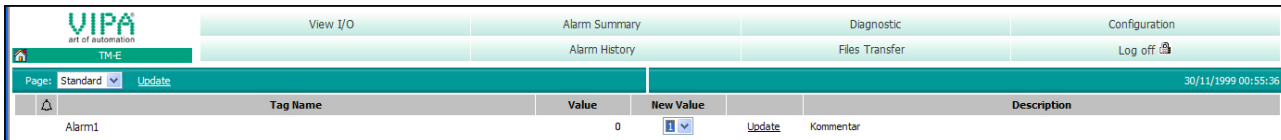

- Reset the value to 0 and click at "Update". The alarm symbol just remains and the value is reset to 0.

In the mean time the TM has sent a SMS to your preset telephone number.

- Please send a SMS with A1 to the telephone number of the GSM card of your TM module. Now you will receive a confirmation SMS with the following text: "Alarm1 was confirmed". The alarm symbol disappears.

Request an eMail report via SMS

With this example it is shown how to receive an extraction of your event file by eMail prompted by SMS. The configuration happens with the following approach:

Configuration of the dial-up server

For the dial-up to the Internet the dial-up server is to be activated.

- Here open the Web page of the TM.
- Navigate to the "Communication" page via **Configuration > System Setup**. Open at the navigation tree **Network connection > Modem > Outgoing** the page "Global".
- Activate the option "PPP outgoing Connection".

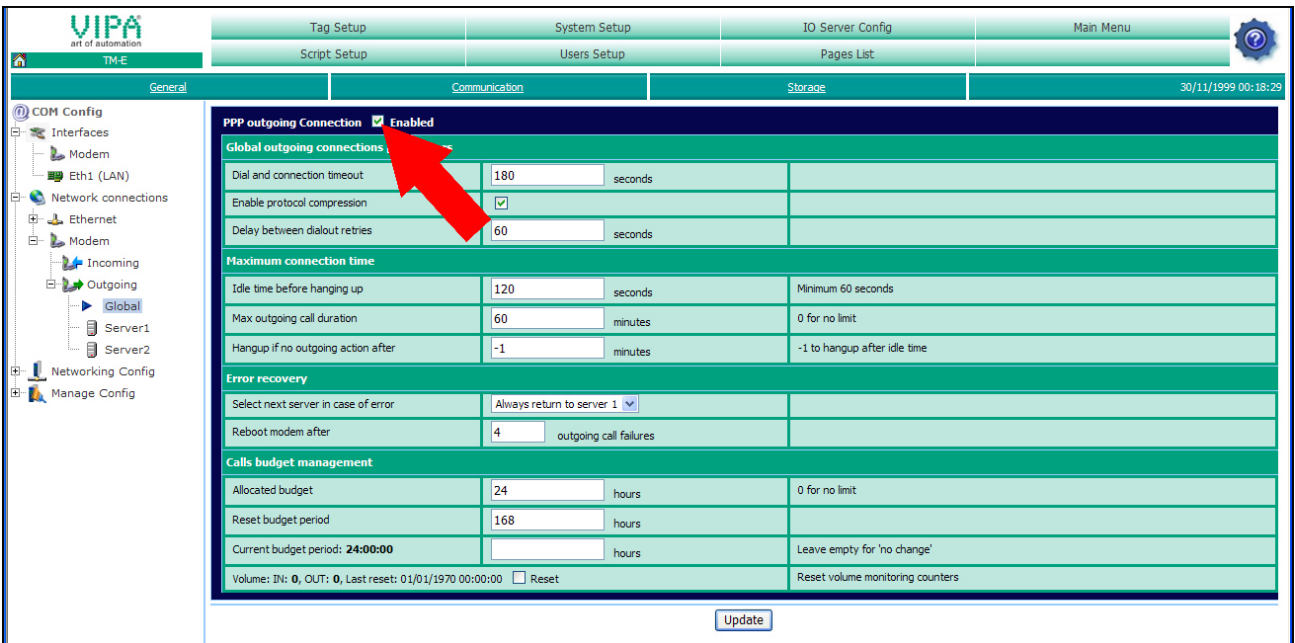

- Leave the values with its standard setting and click at [Update].
- Click at "Server1".

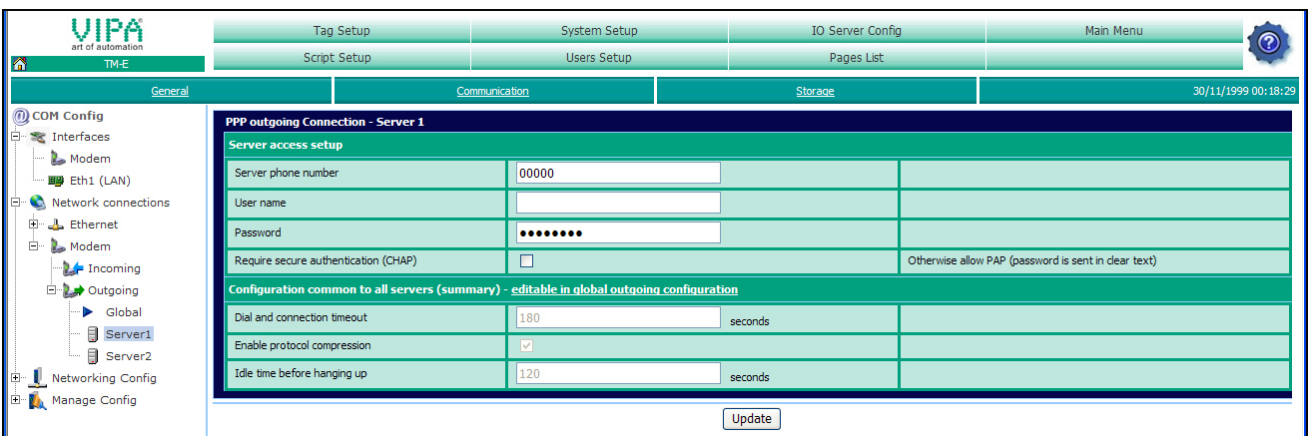

- Type in *Phone number*, *User name* and *Password* for the Modem-dial-up and click at [Update].

Configuration of the Internet connection

- Open at the navigation tree **Network config** the page "Internet Connection".
- Select at "Internet access" the parameter "Modem Connection" and click at [Update].

Configuration of the eMail functionality

- For the eMail configuration navigate via **Configuration** > *System setup* to the page "General". Open the page "SMTP (Mails)" in the navigation tree **Net services**.
- Enter the following parameters:

<i>SMTP server address:</i>	Server address of your eMail provider (outbox).
<i>SMTP server port:</i>	Default 25, this is to be changed very rarely.
<i>eMail "from":</i>	Your eMail address.
<i>User name:</i>	Your eMail user name.
	In most cases it is the same as the eMail address.
<i>Password:</i>	Your eMail password.
- Click at [Update].

Script for requesting an eMail report via SMS

To be able to react to a request SMS, a script at your TM is necessary. The configuration of the script happens with the following approach:

- Navigate to **Configuration** > *Script settings*.
- Stop if not just happened the script processing with [STOP (currently started)].
- Click at [New section], type in as script name "Report" and enter the following programming code:

```
Report:
a%=Getsys Prg,"SmsRead"
If(a%<>0) Then
  s%=s%+1
  PRINT "SMS Nr: ";s%
  f$=Getsys Prg,"smsfrom"
  Print"From: ";f$
  Print Getsys Prg,"smsdate"
  a$=Getsys Prg,"smsmsg"
  Print "Message: ";a$
  b$=f$+",gsm,0"
  If(a$="A1") THEN
    c$="Received message: "+a$
    d$="Report is sent to your eMail"
    Sendsms b$,d$
    Sendmail "mailaddress","", "Event-Mail
      ", "&[$dtEV $ftH $st_d1]"
  Else
    e$="Wrong instruction"
    Sendsms b$,e$
  Endif
  Goto A1_Quit
Endif
End
```

For *mailaddress* type in your eMail address.

- Activating the script
- To confirm the script click at [Update].
 - So that your TM is able to execute the "A1_Quit" script when prompted by SMS, the following lines are to added to the "Init Section":

```
ONSMS "Goto Report"
```

- Confirm with [Update].
- Click at [RUN (currently stopped)] to start the script processing.

Test request a report via SMS

Send a SMS with *Report* to the telephone number of the GSM card of your TM module. Now you will get a confirmation SMS with the following text:
`Report is sent to your eMail.`

Now you should receive an eMail with the added event list.

Appendix

A Index

- A**
- Alarm function..... 3-39
 - Antenna jack 2-7
 - Assembly 1-6, 3-5
- B**
- Backup function 3-12
 - Bit access 3-29
- C**
- Cabling..... 1-8, 3-6
 - Callback 3-35
- D**
- Deployment..... 3-1
 - Dial-up server 3-37
 - Digital I/O 2-6
- E**
- eBuddy..... 3-7
 - EMC 1-9
 - Basic rules 1-10
- F**
- Fast introduction 3-2
 - Firmware update..... 3-11
- H**
- Hardware description..... 2-1
 - Host-ID..... 3-8
 - reserved..... 3-9
- I**
- I/O**
- Access 3-30
 - Connector 2-6
 - Installation dimensions 1-5
 - Installation guidelines..... 1-9
 - Interface
 - MPI/Profibus DP 2-5
 - RJ45 Ethernet..... 2-4
 - Interference influences 1-9
 - IP address..... 3-8
 - at PPP connection 3-23, 3-33
 - Basics 3-8
 - change 3-10
 - Classes 3-9
 - on delivery 3-2
 - Isolation of conductors..... 1-11
- L**
- LEDs 2-3
- M**
- Mail gateway..... 3-35
 - Mail server 3-38
 - MPI 3-31
- N**
- Net-ID 3-8
 - NetPro 3-20
- P**
- PG/PC interface..... 3-19
 - via eVCOM 3-24
 - PLC..... 3-16
 - Linking 3-16
 - Project integration 3-19
 - via eVCOM 3-24
 - Routing 3-33
 - Teleservice 3-28
 - Power supply 2-6
 - Profile rails..... 1-6, 3-5
 - Properties 2-2
- R**
- Removal 1-7
 - Reset 2-5, 3-13
- S**
- Safety information..... 1-2
 - SIM card 1-3, 3-26
 - SMS 3-39
 - Station file..... 3-19
 - Structure 2-3
 - Subnet mask 3-8
- T**
- Tag 3-28
 - Name conventions..... 3-29
 - Technical Data..... 2-8
 - Telephone conn..... 3-32, 3-36
 - Teleservice
 - Callback function 3-35
 - SMS..... 3-39
 - Telephone
 - MPI gateway 3-31
 - Topic..... 3-17
- W**
- Web page 3-14
 - Access data..... 3-14
 - Structure..... 3-15

