



**TURCK**

Industrial  
Automation

**FIELDBUS  
TECHNOLOGY**

**MODULAR  
I/O SYSTEMS  
AND COMPACT  
I/O MODULES IN  
IP20 AND IP67**

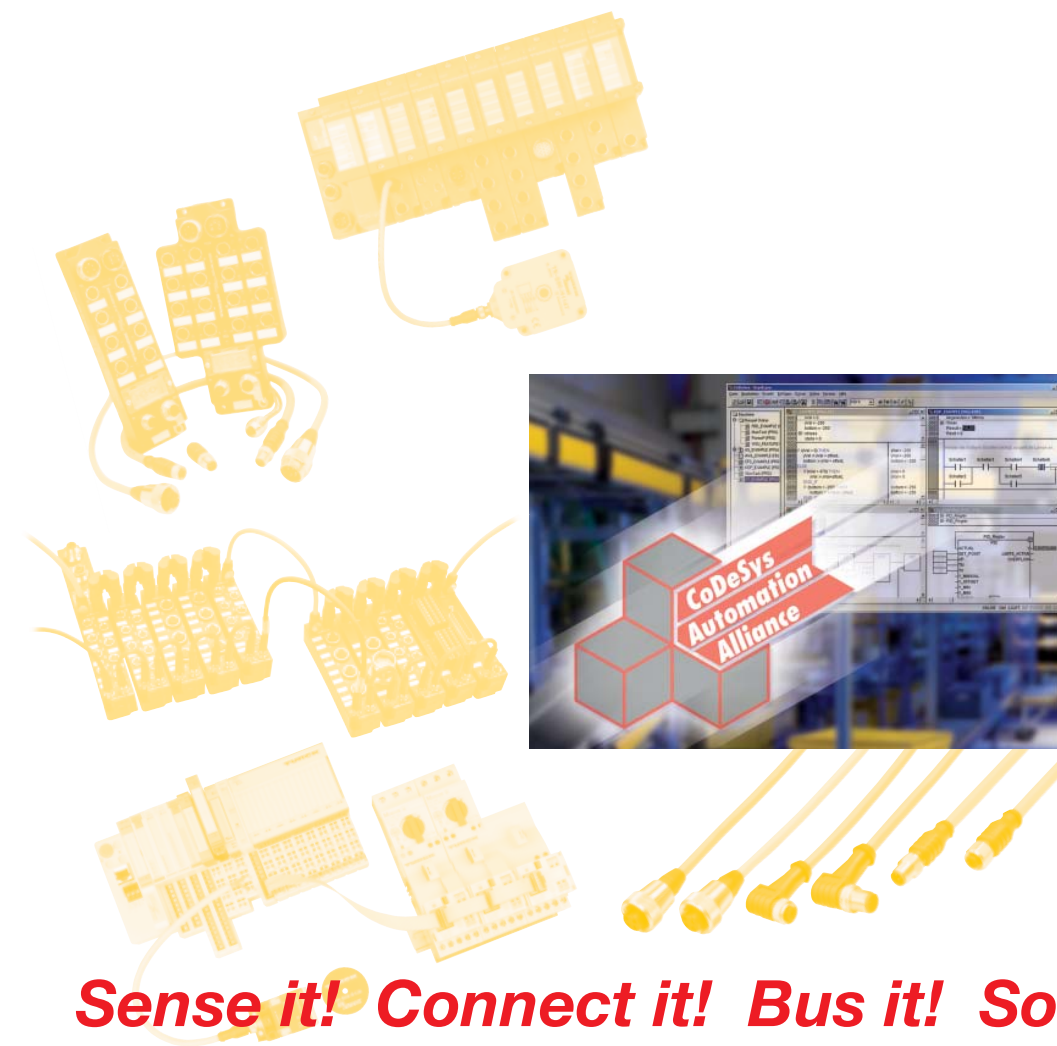

***Sense it! Connect it! Bus it! Solve it!***

# The Company

TURCK is one of the leading companies in the field of industrial automation. The family enterprise with more than 2700 employees in 25 countries and representations in further 60 states, achieves a turnover of nearly 330 million euros.

With production sites in Germany, Switzerland, USA, Mexico and China, today TURCK has succeeded in adapting to the conditions of local markets. Despite international orientation, the company's core competence and the main production sites equipped with the latest machinery, will remain in Germany.

## SENSE IT!



### SENSOR TECHNOLOGY



### CONNECTION TECHNOLOGY



## CONNECT IT!



With more than 13000 products covering the areas sensor, fieldbus, interface and connection technology, TURCK offers the full range of solutions for factory and process automation. Examples for the outstanding innovation skills of the company are the inductive *uprox*<sup>®</sup>+ factor1 sensor, the modular I/O system BL67 and *excom*<sup>®</sup> the compact remote I/O system for application in explosion-hazardous areas.

Whether for machine & system engineering, automotive, transport & handling, food & beverage or the chemical and pharmaceutical industries, TURCK products optimise the system availability with robust and reliable technologies. Due to effective standardisation, the smart solutions also contribute to cost savings in purchase, inventory management, installation and maintenance.

## **BUS IT!**

**FIELDBUS TECHNOLOGY**



## **SOLVE IT!**

**RFID SYSTEM**



# Service & Support

A fast shipment service and a comprehensive e-support system perfectly complement the extensive TURCK programme.

With the product database, available on [www.turck.com](http://www.turck.com), TURCK offers a fast way to problem solving around the clock, seven days a week, at any place in this world and in six different languages.

Around 13000 products, clearly structured and completely documented, are ready for you to download together with all the necessary information you need. Please have a look on: [www.turck.com](http://www.turck.com)

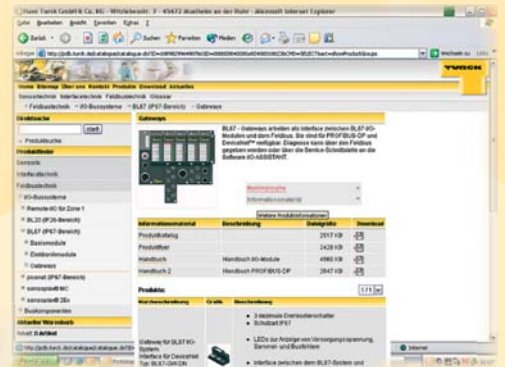

# Modular I/O systems and compact I/O modules in IP20 and IP67

**TURCK**

Industrial  
Automation

Modular I/O systems and compact I/O modules in IP20 and IP67		Page
Overview modular I/O systems und compact I/O modules in IP20 and IP67		6
Overview <i>BL ident</i> <sup>®</sup> – modular RFID system		8
System description PROFIBUS-DP		10
System description DeviceNet™		12
System description CANopen		14
System description Ethernet		16
System description INTERBUS		18

Page
6
8
10
12
14
16
18

1

## BL67 – Modular I/O system in IP67

21

2

## *piconet*<sup>®</sup> – Modular I/O system in IP67

109

3

## Compact fieldbus I/O modules in IP67 and IP20

249

4

## BL20 – Modular bus terminal I/O system in IP20

327

5

## Accessories

A0 – A5

A

## Type index

450

# Modular I/O systems and compact I/O modules

**Perfect connections** – no matter which fieldbus you use; TURCK provides you with a complete range of products:

- Modular and compact I/O systems in a variety of housing styles and IP-ratings
- Optimal support for planning, commissioning and service with the I/O-ASSISTANT software tool
- Decentralised intelligence with IEC 61131

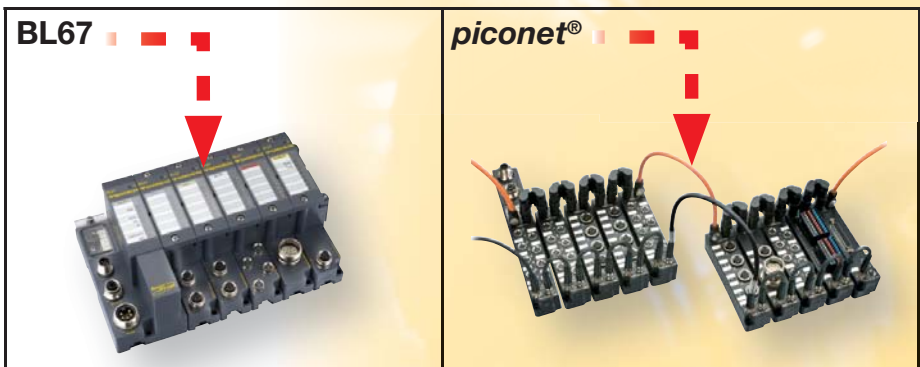

Composition	
Modular	✓
Compact	✓
IP20	✓
IP67	✓
Functions	
Digital I/O	✓
Analogue I/O	✓
Technology modules	✓
Fieldbus interfaces	
PROFIBUS-DP	✓
DeviceNet™	✓
CANopen	✓
Interbus	✓
PROFINET IO	✓
EtherNet/IP	✓
Modbus TCP	✓
System support	
Motor starter	
RFID	✓
Valve terminals	✓
Zone 2	
Software	
CoDeSys programmable	✓
I/O-ASSISTANT	✓

1) FXDP modules  
2) FXEN modules

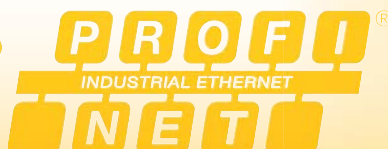
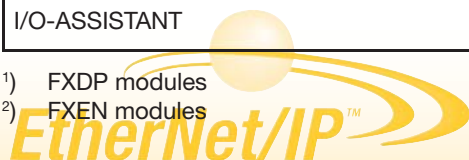

Ethernet Modbus TCP

**Compact I/O modules**

IP67 



IP20 



BL20 

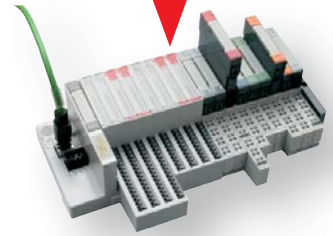

		✓
✓	✓	
	✓	✓
✓		
✓	✓	✓
		✓
		✓
✓	✓	✓
✓		✓
		✓
✓		✓
✓		✓
✓		✓
		✓
		✓
		✓
✓ <sup>1)</sup>		✓
		✓
✓ <sup>2)</sup>		✓

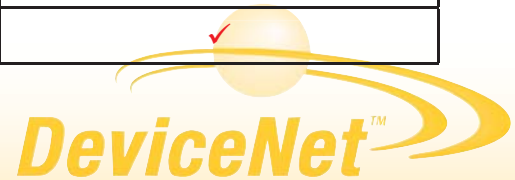

# The *BL ident*<sup>®</sup> modular RFID system

## Make use of the advantages!

*BL ident*<sup>®</sup> is a complete RFID system which is mainly designed for industrial applications and thus develops its special strengths in this field. It is based on the modular I/O systems BL67 (field application) and BL20 (cabinet mounting) and consists of data carriers (tags), read-write heads, interconnects and gateways.

The data carriers are adjusted to the correspondent industrial application. The product portfolio comprises not only extremely quick and almost infinitely re-writeable FRAM data carriers, but also high temperature versions with an applicability of up to 210 °C which can be applied in coating lines. Moreover, *BL ident*<sup>®</sup> can be integrated in existing BL67 and BL20 I/O systems without any problems.

Make use of the new advantages for industrial applications with RFID solutions made by TURCK.



### The *BL ident*<sup>®</sup> system guarantees significant potentials for cost-saving:

- Easy integration in the existing control world
- Efficient production and increased system availability

The short period of amortisation and a quick ROI (Return on Investment) of the system are a considerable contribution to the success of your company.



### *BL ident*<sup>®</sup> speeds up your production and increases efficiency:

- Fast FRAM technology (0.5 ms/Byte)
- Parallel processing of data with up to 8 channels per gateway
- Read and write „on the fly“



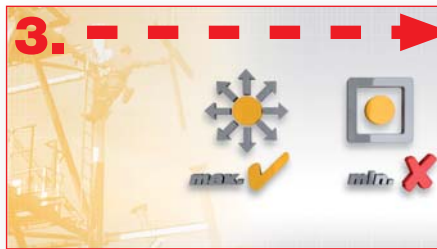

**BL ident® offers maximum freedom and highest flexibility with respect to system integration. Your projects can thus be implemented quicker:**

- Read-write heads are available in industrial housings (M18, M30, CK40, Q80, S32XL, Q350), in IP67/IP69K and read-write distances of up to 500 mm!
- Robust IP68 tags
- Modular interfaces allow the integration of additional I/O modules
- Up to 50 m connection cable between read-write head and interface
- Extensive range of mounting accessories
- Multiple fieldbus interfaces such as PROFIBUS-DP, EtherNet/IP, Modbus TCP, DeviceNet™ and PROFINET IO, in IP20 and IP67
- Programmable gateways with decentralised pre-processing relieve the higher-level control and bus system



**With the BL ident® technology, maintenance intervals can be extended, thus improving system availability:**

- High safety level due to long data storage period (10 years if operated at prescribed temperature)
- nearly infinite re-writing of the FRAM data carriers ( $10^{10}$ ), EEPROM:  $10^5$
- Extremely resistant:  
The materials used for the read-write heads of the WD-series are resistant to all common acid and alkaline detergent and disinfectants. Problems caused by aggressive cleaning materials are thus reduced to a minimum



**Easy maintenance is a further contribution of the BL ident® system to safety and cost reduction:**

- No down-times of the system due to the „Hot-Swapping“ function
- Local display of the fieldbus diagnostics directly in the field by LEDs on the read-write heads and on the interface
- Connection to other fieldbuses is simply implemented by replacing the gateway – the remaining configuration is left unchanged
- Same mounting accessories as for inductive sensors – less mounting accessories are needed

# System description PROFIBUS-DP (Overview)

## PROFIBUS-DP

- Open fieldbus standard according to EN 50170
- Transmission medium: 2-wire cable, twisted, shielded
- Transmission technology: RS485
- Bus topology: line structure with bus termination at both ends
- Bus access mode: Master-Slave/Master-Master with "Token Passing"
- 32 stations per segment, max.126 stations.
- Repeater modules for signal regeneration
- Addressing via coding switches
- Configuration/parameterisation of devices via standardised device data base files (GSD files = Gerätestammdaten-Dateien)

PROFIBUS (Process Field Bus) is a standardised and open communication fieldbus. It complies with EN 50170 and consists of three different protocol profiles:

- PROFIBUS-FMS (Fieldbus Message Specification) is primarily designed for data exchange between programmable logic controllers (PLCs or PCs).
- PROFIBUS-DP (Decentral Periphery) is designed for fast data exchange between the central control and the remote field devices
- PROFIBUS-PA (Process Automation) is an intrinsically safe network for the process industry.

TURCK fieldbus components support PROFIBUS-DP. Within the PROFIBUS-DP network, the central control (e.g. the PLC) communicates with the remote input and output stations via a fast serial connection.

Data are exchanged cyclically between master and slave.

PROFIBUS-DP systems excel in their fast system response times. At a transmission rate of 12 Mbps, 512 bit input and 512 bit output data can be transferred, for instance, in less than 2 ms to 32 stations.

The system speed corresponds to the transmission rate set via the PROFIBUS master. The transmission speed is automatically detected by the TURCK PROFIBUS modules (auto baud).

The manufacturer provides device data base files (GSD files = Gerätestammdaten) for the individual PROFIBUS stations for configuration. TURCK additionally offers the I/O-ASSISTANT, a helpful software tool for configuration, parameterisation and set-up of the individual modules.

Transmission speed	Length of bus line (max.)	Max. numbers of repeaters <sup>1)</sup>	Max. numbers of stations
9,6...93,75 kbps	1200 m	2	126
187,5 kbps	1000 m	2	126
500 kbps	400 m	4	126
1500 kbps	200 m	6	126
3000...12000 kbps	100 m	9	126

<sup>1)</sup> At maximum transmission speed up to 9 repeaters of the TURCK series REP-DP 0002 can be connected in series (applicable to DP-profile bus parameters). If more repeaters are to be cascaded, the bus timing parameters must be adapted accordingly by the user.

Systemdaten PROFIBUS-DP	
Number of I/O stations	126 (incl. Repeater)
Number of I/O points	approx. 6000, depending on master
Transmission medium	shielded twisted copper cable, 2 x 0.34 mm <sup>2</sup>

**Application example: TURCK fieldbus components for PROFIBUS-DP**

The schematic representation below shows a PROFIBUS-DP network based on components offered by TURCK. In addition to BL67 fieldbus stations in IP67, TURCK offers further modular bus components in IP20 (BL20) and IP67 (miniature piconet® modules and com-

pact fieldbus stations) which are characterised by flexibility and a user-friendly set-up.

Premoulded cables in various designs, as well as field-wireable connectors, feed-through receptacles for cabinet mounting, flange connectors, T-pieces,

terminating resistors and repeaters are available for network construction.

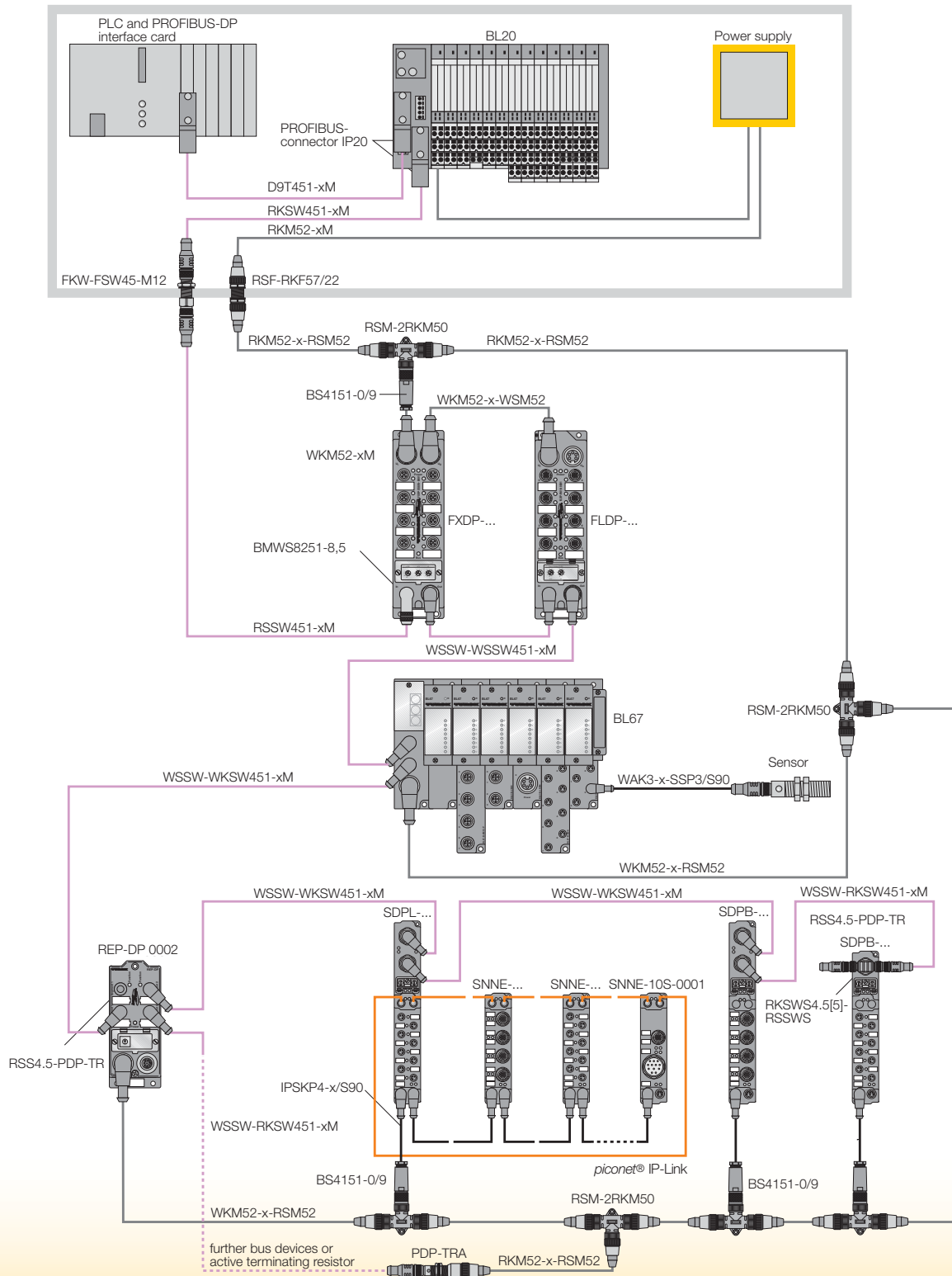

# System description DeviceNet™ (Overview)

## DeviceNet™

- Open fieldbus standard according to EN 50325
- Transmission medium: 2-pair cable, twisted shielded, for data transmission and for power supply (24 volt)
- Transmission technology: CAN
- Bus topology: Line structure (bus termination at both ends) with drop lines
- Bus access mode: Multi-master system with CSMA/CA access mode, network-wide multi/broadcasting
- Use of repeaters in order to extend the length of the trunk and drop line
- Max. 64 nodes (incl. master)
- Addressing via coding switches
- Configuration/parameterisation of the devices via standardised EDS files (Electronic Data sheets)

DeviceNet™ is an open, standardised bus system according to EN 50325 and is based on the CAN specification (Controller Area Network). As a multimaster system DeviceNet™ provides the following I/O communication modes:

- Polling: the master module cyclically sends output data to all subordinate slaves and receives input data via the response message.
- Change of state: telegrams are not sent constantly, but only if the contents has changed, i.e. the process image/mapping is only transferred when it changes.
- Cyclic: the nodes automatically send data after a certain cycle time
- Strobed: the scanner requests input data via a broadcast message to all bus nodes.

TURCK fieldbus components support all these I/O communication modes. The bus length depends on the transmission speed (125, 250 or 500 kbps) as shown in the table below. Due to this especially efficient usage of the bus capacities, it is possible to achieve short response times, particularly in the change-of-state mode (despite relatively low data rates).

The manufacturer provides EDS files (EDS = Electronic Data Sheet) for configuration of the individual DeviceNet™ nodes.

DeviceNet™ devices are parameterised via acyclic services (Explicit Messaging). TURCK additionally offers the I/O-ASSISTANT, a helpful software tool for configuration, parameterisation and set-up of the individual modules.

## DeviceNet™ – Transmission speed and bus lengths

Transmission speed	Bus lines – max. length				Drop lines – max. length		Number of nodes (max.)
	Flat Cable	Thick Cable	Mid Cable	Thin Cable	(per drop)	(total)	
125 kbps	420 m	500 m	300 m	100 m	6 m	156 m	64
250 kbps	200 m	250 m	250 m	100 m	6 m	78 m	64
500 Kbps	75 m	100 m	100 m	100 m	6 m	39 m	64

System data DeviceNet™	
Number of nodes	64 (incl. master)
Number of I/O points	depending on control system
Transmission medium	shielded twisted copper cable, at least 2 x 2 x 0.21 mm <sup>2</sup>
I/O communication modes	polling, change of State, cyclic, strobed

**Application example: TURCK fieldbus-components for DeviceNet™**

The schematic representation below shows a DeviceNet™ network based on components offered by TURCK. In addition to BL67 fieldbus stations in IP67, TURCK offers further modular bus components for the IP20 (BL20) and the

IP67 environment (miniature *piconet®* modules and compact fieldbus stations) which are characterised by flexibility and user-friendly set-up. Premoulded cables in various designs, as well as field-wireable connectors,

feed-through receptacles for cabinet mounting, flange connectors, T-pieces, terminating resistors and repeaters are available for network construction.

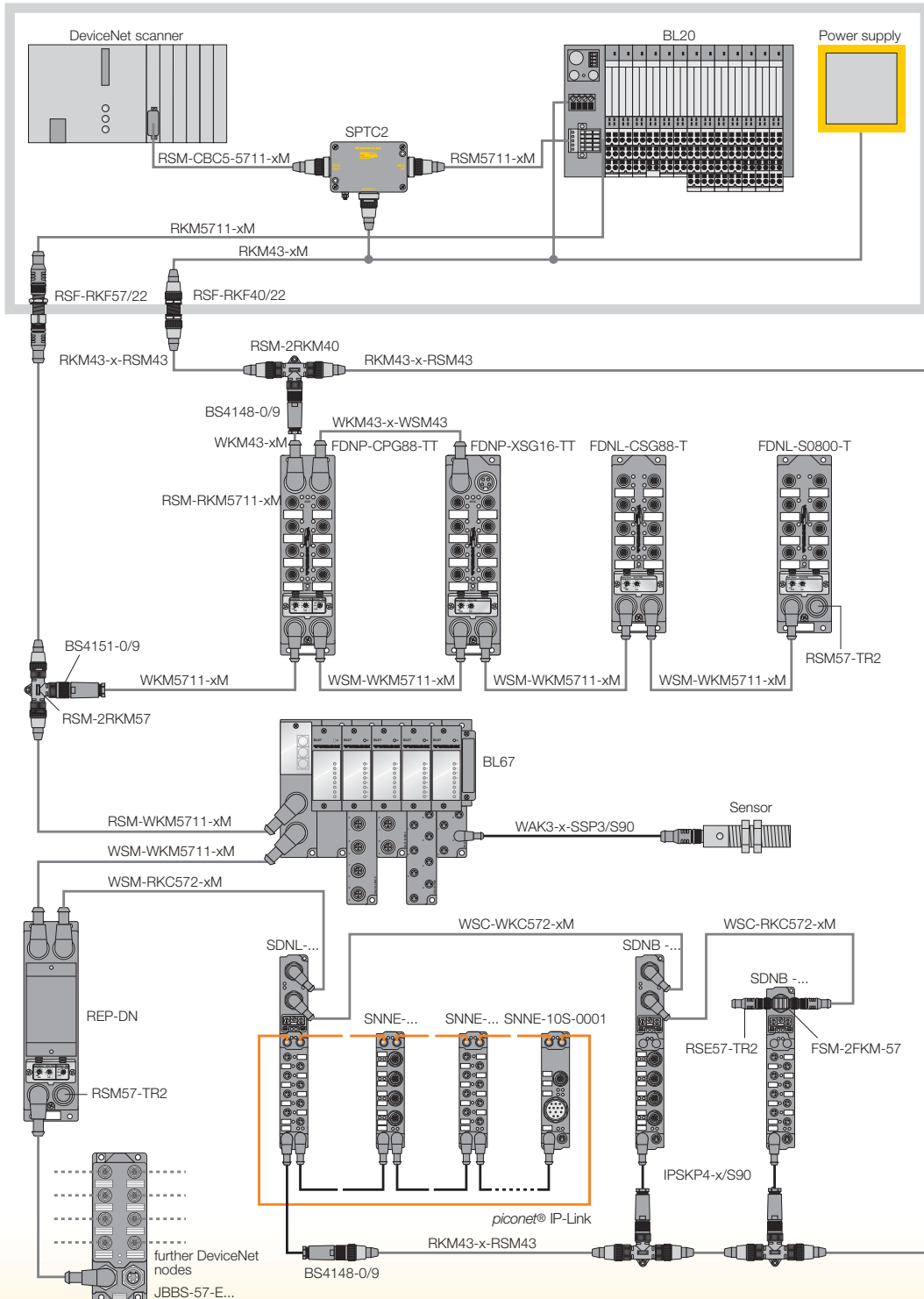

# System description CANopen (Overview)

## CANopen

- Open fieldbus standard according to EN 50325-4
- Transmission medium: 2-pair cable, twisted and shielded, for data transmission and for power supply (24 volt)
- Transmission technology: CAN
- Bus topology: Line structure (bus termination at both ends) with drop lines
- Bus access mode: Multi-master system with CSMA/CA access mode, network-wide multi/broadcasting
- Max. 127 nodes (incl. repeaters)
- Addressing via coding switches
- Use of repeaters in order to extend the length of the trunk and drop line
- Configuration/parameterisation of the devices via standardised EDS files (Electronic Data sheets)

The CAN user layer CANopen consists of device profiles, which standardise the data contents of the respective device categories, and of communication profiles. The communication profile determines the method of data exchange between the devices. In this context, one differentiates between real time data (process data objects – PDO) and parameter data (service data objects – SDO). CANopen defines different communication modes for the transmission of the process data (PDOs):

- Event-controlled: Messages are sent as soon as the content has changed. Therefore, the process image/map ping is not transferred permanently; only the changed signals are transmitted.
- Cyclic synchronous mode: The components are requested to accept the output data received and to send new input data via a SYNC telegram.

- Request-controlled: The components are triggered to send their input data via a CAN data request message.

CANopen devices are parameterised via SDOs. These are primarily used to transfer parameters during device configuration and to transmit longer data fields. Due to effective usage of the bus bandwidth CANopen offers short system response times despite a relatively low transmission speed (max. 1 Mbps).

The manufacturer provides EDS files (EDS = Electronic Data Sheet) for configuration of the individual CANopen nodes. TURCK additionally offers the I/O-ASSISTANT, a helpful software tool for configuration, parameterisation and set-up of the individual modules.

Transmission speed	Bus trunk line (max.)	Number of nodes (max.)
10 kbps	5000 m	127
20 kbps	2500 m	127
50 kbps	1000 m	127
125 kbps	500 m	127
250 kbps	250 m	127
500 kbps	100 m	127
800 kbps	50 m	127
1000 kbps	25 m	127

System data CANopen	
Number of I/O stations	127 (incl. Repeater)
Number of I/O points	depending on control system
Transmission medium	shielded twisted copper cable, at least 2 x 2 x 0.21 mm <sup>2</sup>

### Application example: TURCK fieldbus-components for CANopen

The schematic representation below shows a CANopen network based on components offered by TURCK. In addition to BL67 fieldbus stations in IP67 TURCK offers further modular bus components for the IP20 (BL20) and the IP67 environment (miniature *piconet*® modules and compact fieldbus stations)

which are characterised by flexibility and user-friendly set-up. Premoulded cables in various designs, as well as field-wireable connectors, feed-through receptacles for cabinet mounting, flange connectors, T-pieces, terminating resistors and repeaters are available for network construction.

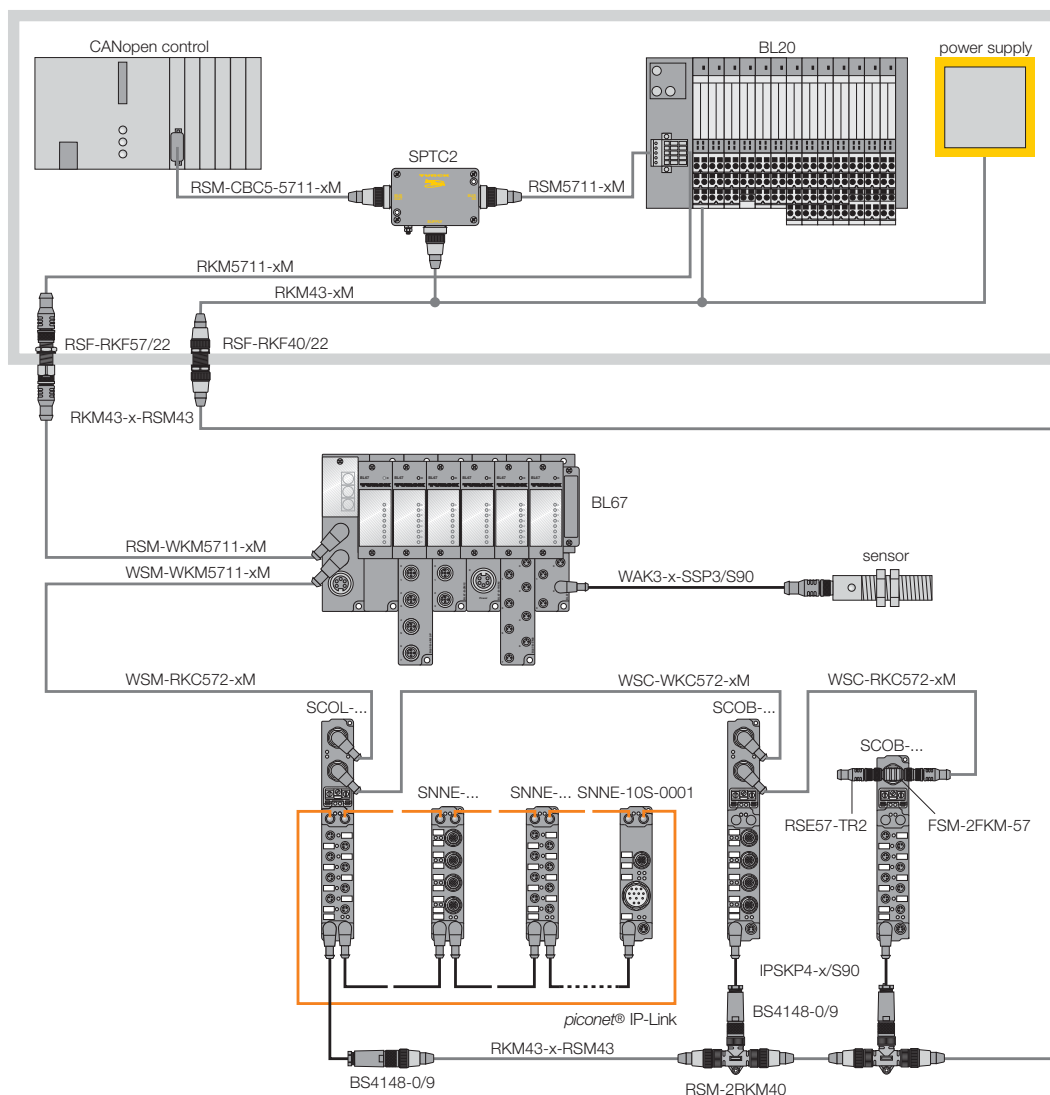

# System description Ethernet (Overview)

## Ethernet

- **Open fieldbus standard acc. to IEE 802.3**
- **Transmission medium: 2 x 2 twisted-pair copper cable, shielded, category 3 (10 Mbps), category 5 (100 Mbps)**
- **Bus topology: star structure/ tree structure**
- **Switches and hubs as junction points for connection of the Ethernet nodes**
- **Bus access mode: multi-master system with CSMA/CD access mode, network-wide multi/broadcasting**
- **Number of bus nodes theoretically unlimited**
- **Protocols: MODBUS TCP, EtherNet/IP und PROFINET IO**

The term Ethernet generally refers to the IEEE 802.3 specification. The modules are networked within a tree or star structure and are identified using a 6-byte, world-wide and unique identification code (MAC ID). The distance between two bus nodes may not exceed 100 m when using rigid cables. If flexible cables are used, the maximum length depends on the network construction.

Switches and hubs interconnect the Ethernet nodes and are thus the nodal points within the network. Hubs always send data to and receive data from all nodes, whereas switches feature a selective data transmission mode. Switches dynamically maintain a list with the IP addresses of all connected bus nodes. This ensures that data are only sent to the relevant target address. Data collisions are avoided and the network bandwidth is increased.

The original Ethernet protocol transfers the data frame from one to a single or several other nodes. The transmission mode does not include acknowledgement messages (handshake communication) and re-transfer of lost data frames. The Internet Protocol (IP) handles segmenting, routing (path finding), searching and allocation of the permanent MAC-IDs.

Just like the Ethernet protocol, the IP does not ensure secure data transport. Data frames can get lost or be disrupted in their order.

Protocols such as TCP/IP, which ensure safe data transmission, are available. The Transmission Control Protocol (TCP) is based on the IP and is a connection-orientated transfer protocol, comprising error diagnostics and error handling mechanisms. This protocol ensures that lost telegrams are re-transmitted. Based on TCP, further protocols such as MODBUS TCP, EtherNet/IP and PROFINET IO have been developed for applications involving industrial data communication.

System data Ethernet	
Number of I/O stations	only limited through IP address area
Number of I/O points	depending on control system
Transmission medium	2 x 2 twisted-pair copper cable, shielded, category 3 (10 Mbps), category 5 (100 Mbps)
Line length	max. 100 m distance between the modules



## Application example: TURCK-Fieldbus components for Ethernet

The schematic representation below shows an Ethernet network based on components offered by TURCK. In addition to BL67 fieldbus stations in IP67, TURCK offers further modular bus components for the IP20 (BL20) and the IP67 environment (miniature *piconet*<sup>®</sup>

modules and compact fieldbus stations) which are characterised by flexibility and user-friendly set-up. Premoulded cables in various designs, as well as field-wireable connectors, feed-through receptacles for cabinet mounting.

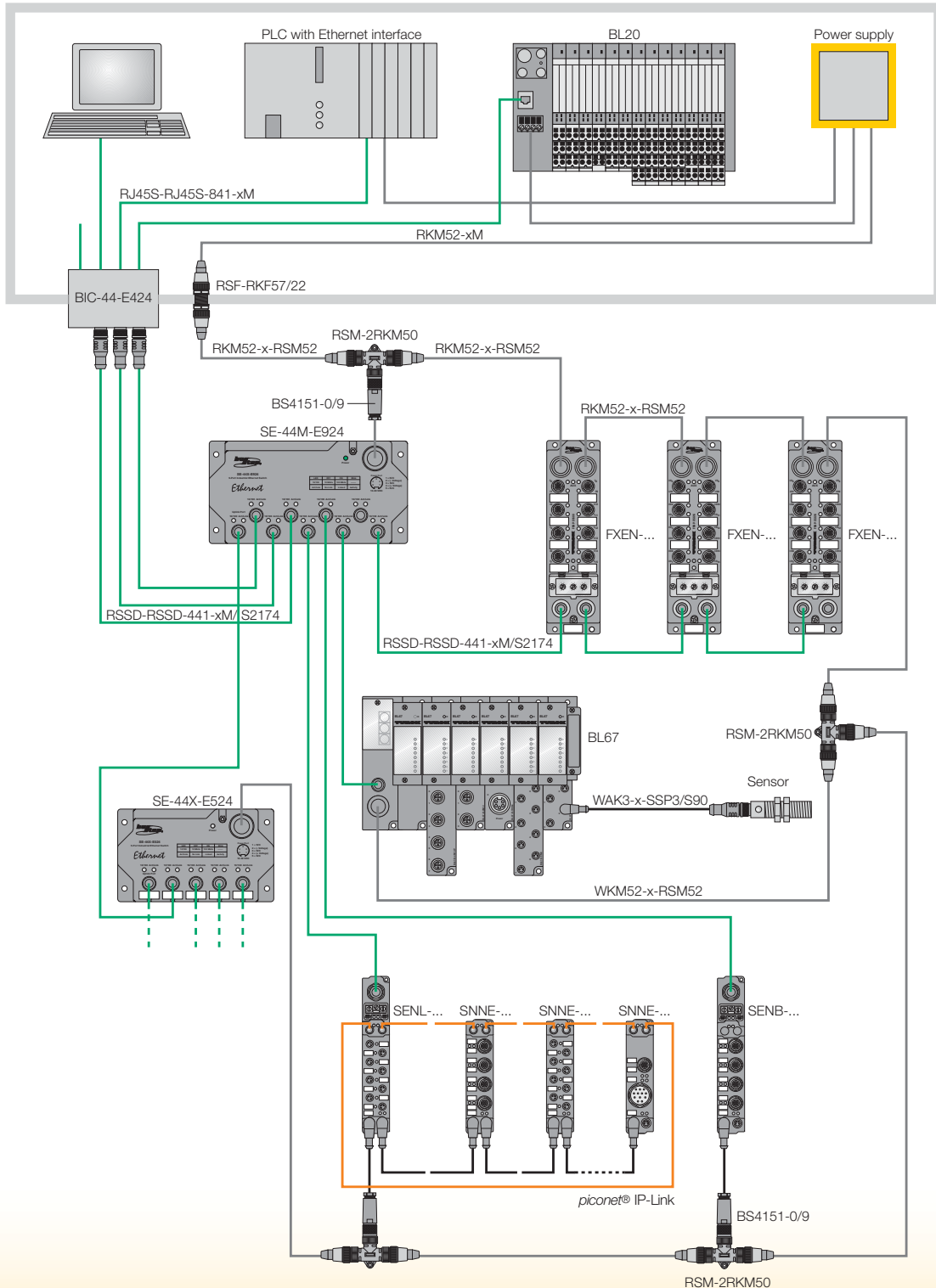

# System description INTERBUS (Overview)

## INTERBUS

- **Open fieldbus standard acc. to IEC 61158**
- **Transmission medium: multicore cable, 6-wire, twisted, shielded**
- **Transmission technology: RS485**
- **Bus topology: active ring, each node acts as a repeater**
- **Bus access mode: Master/slave system, defined telegram length, deterministic**
- **Max. 512 nodes**
- **Addressing: automatic addressing according to the physical order of the nodes within the system**

INTERBUS is an open and standardised fieldbus system according to IEC 61158. The system always features a ring structure. All bus nodes are actively interconnected within a closed transmission path.

In contrast to other ring systems, the data forward and data return line of the INTERBUS system are routed in a single cable. The last node automatically terminates the ring. Based on this construction, the physical appearance of a line

or tree structure can be created. Several sub-systems for structuring the entire system can be branched off the main (trunk) line which exits the master. As a result, the bus system can be flexibly adapted to any application.

Bus access is based on the master/slave mode, in which data are sent from the master to the first node and then transferred sequentially from one node to the other. Due to its active coupling, each node functions as a repeater, which regenerates the signal.

Up to 512 nodes can be connected to the so-called "data highway". The distance between the individual nodes is specified with 400 m max., so that the total length of the "data highway" amounts to 12 km max. (copper cables).

The data transmission rate is 500 kbps. The cycle time depends on the user data volume of the respective system and increases linearly with the number of I/O points.

INTERBUS operates on the summation frame method. As the summation frame is always identical, the cycle time is also constant. Thus deterministic operation is ensured.

### Addressing

Data are allocated to the individual nodes automatically according to their physical order in the ring. It is thus not required to assign a bus address to each node via coding switches.

### Configuration

With INTERBUS, configuration is triggered via an identification cycle. Via this cycle the master automatically detects all connected devices. Identification is accomplished via an identification code which is stored in each node and a length code, containing the length of the data to be transferred.

## System data INTERBUS

Number of I/O stations	depending on master (max. 512)
Number of I/O points	depending on master
Transmission medium	LiYCY 3 x 2 x 0,22 mm <sup>2</sup>
Line length	max. 400 m between the modules
Transmission speed	500 kbps
Transmission time	approx. 1 ms with 10 modules for each 32 bits inputs/outputs

## piconet® modules

	<b>for coupling modules, type SIBL-...</b>	<b>for stand-alone modules, type SIBB-...</b>
Number of extension modules, type SNNE-...	max. 120 with max. 64 bytes input- and 64 bytes output data	–
Digital periphery signals	max. 512 inputs and 512 outputs	according to I/O version
Analogue periphery signals	max. 28 inputs and 28 outputs	according to I/O version
Transmission speed	500 kbps	

## INTERBUS bus connection

- 1 x M23 male connector, 9-pole
- 1 x M23 female connector, 9-pole

Fieldbus input (M23)

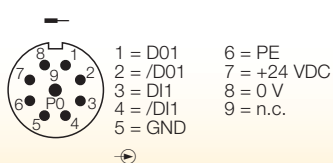

Fieldbus input (M23)

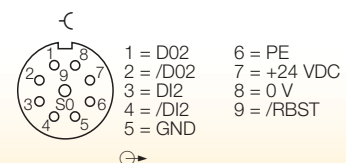

**Application example: TURCK fieldbus components for INTERBUS**

The schematic representation below shows an INTERBUS network based on components offered by TURCK.

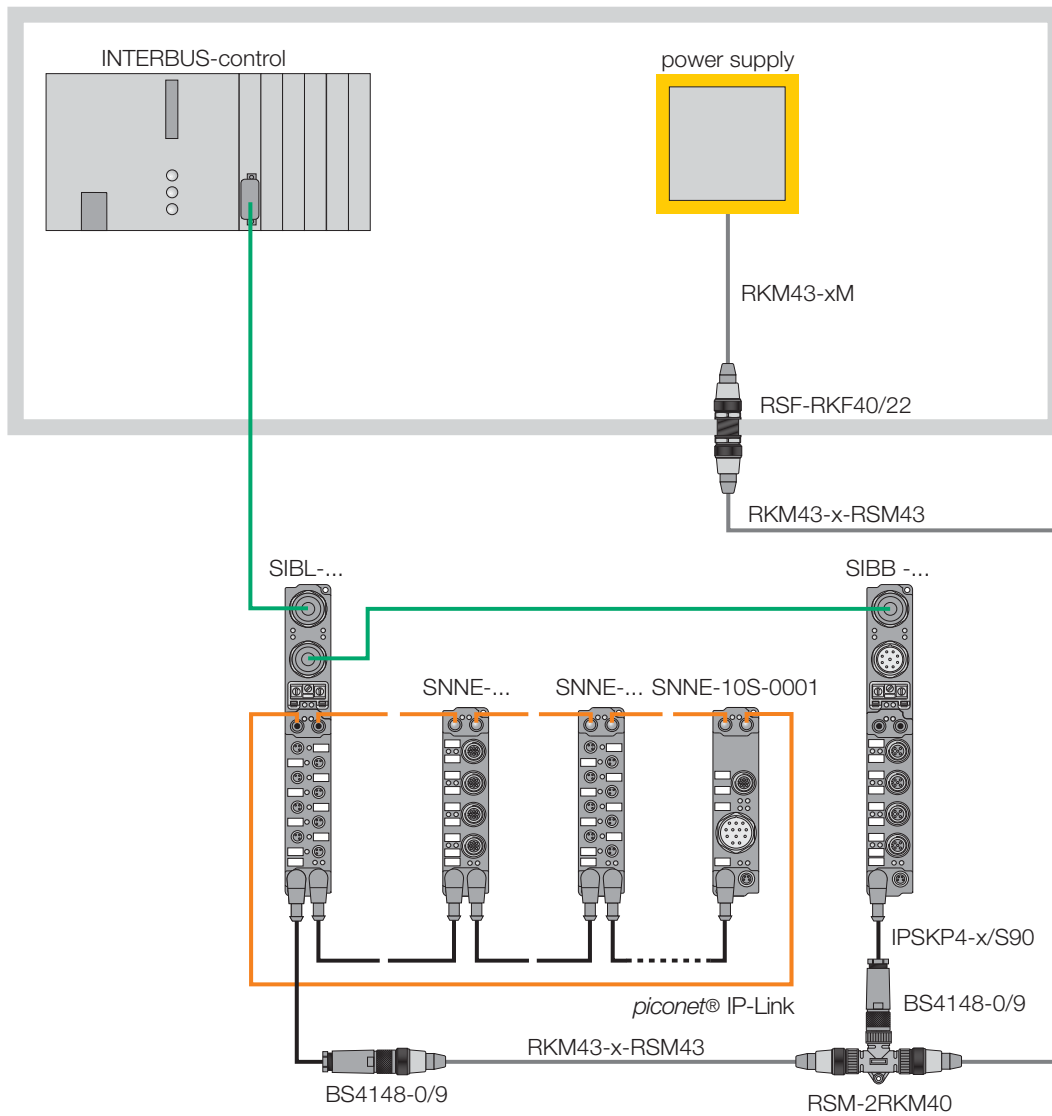

**DIGITAL**  
**ANALOGUE**  
**TECHNOLOGY**  
**RFID**

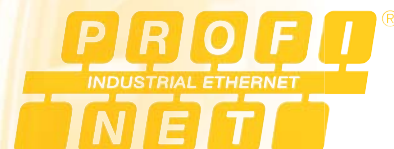

**CANopen**

**Modbus TCP**



# BL67 – Modular fieldbus I/O-system in IP67



<b>BL67 – General</b>	<b>Page</b>
BL67 – System concept	22
BL67 – CoDeSys and I/O-ASSISTANT	24
BL67 – Type code/process data mapping	26
BL67 – Combination options	28
BL67 – Maximum system extension / System supply	30
BL67 – Supply concept	32
BL67 – General technical data	34
BL67 – Special accessories	36
BL67 – Function principle	37

<b>BL67 – Gateways</b>	<b>Page</b>
Gateway for PROFIBUS-DP	38
Gateway for DeviceNet™	39
Gateway for CANopen	40
Gateway for MODBUS TCP	42
Gateway for PROFINET IO	43
Gateway for EtherNet/IP	44

<b>BL67 – Programmable gateways</b>	<b>Page</b>
Gateway for PROFIBUS-DP	45
Gateway for MODBUS TCP	46
Gateway for EtherNet/IP	47

<b>BL67 – Electronic modules and corresponding base module</b>	<b>Page</b>
Power feeding modules	48
Digital input modules	50
Digital output modules	62
Digital input/output modules	76
Analogue input modules	80
Analogue output modules	90
RS232 interface	94
RS485/422 interface	96
SSI interface	98
Counter module	100
CANopen interface	102
BL ident® RFID modules	104



# The BL67 I/O system – the modular I/O system in IP67

## Gateway:

### The system control

- The interface to the higher level control system
- Gateways for PROFIBUS-DP, CANopen, DeviceNet™, PROFINET IO, EtherNet/IP and Ethernet Modbus TCP



## Optional:

### CoDeSys-programmable according to IEC 61131

- Relieves higher-level controller and bus system
- I/O modules independent of the fieldbus
- Prefabricated function blocks e.g. for the RFID *BL ident*® system and serial interfaces

## Power Feeding Module

- Power supply for the field, sensors and actuators
- Enables the creation of potential groups which can be switched on or off according to the requirements of the application

## Operation control with Pick-to-Light sensors

- Combined digital modules enable one input and one output per M12 connector
- Prefabricated standard M12 sensor cables

## BL ident® system

- The modular RFID system made by TURCK
- Modular extension, up to 8 channels
- Temperature range of the data carriers between -40 and +210 °C



**EtherNet/IP™**

**PROFI**  
INDUSTRIAL ETHERNET  
**NET**

**Modbus TCP**

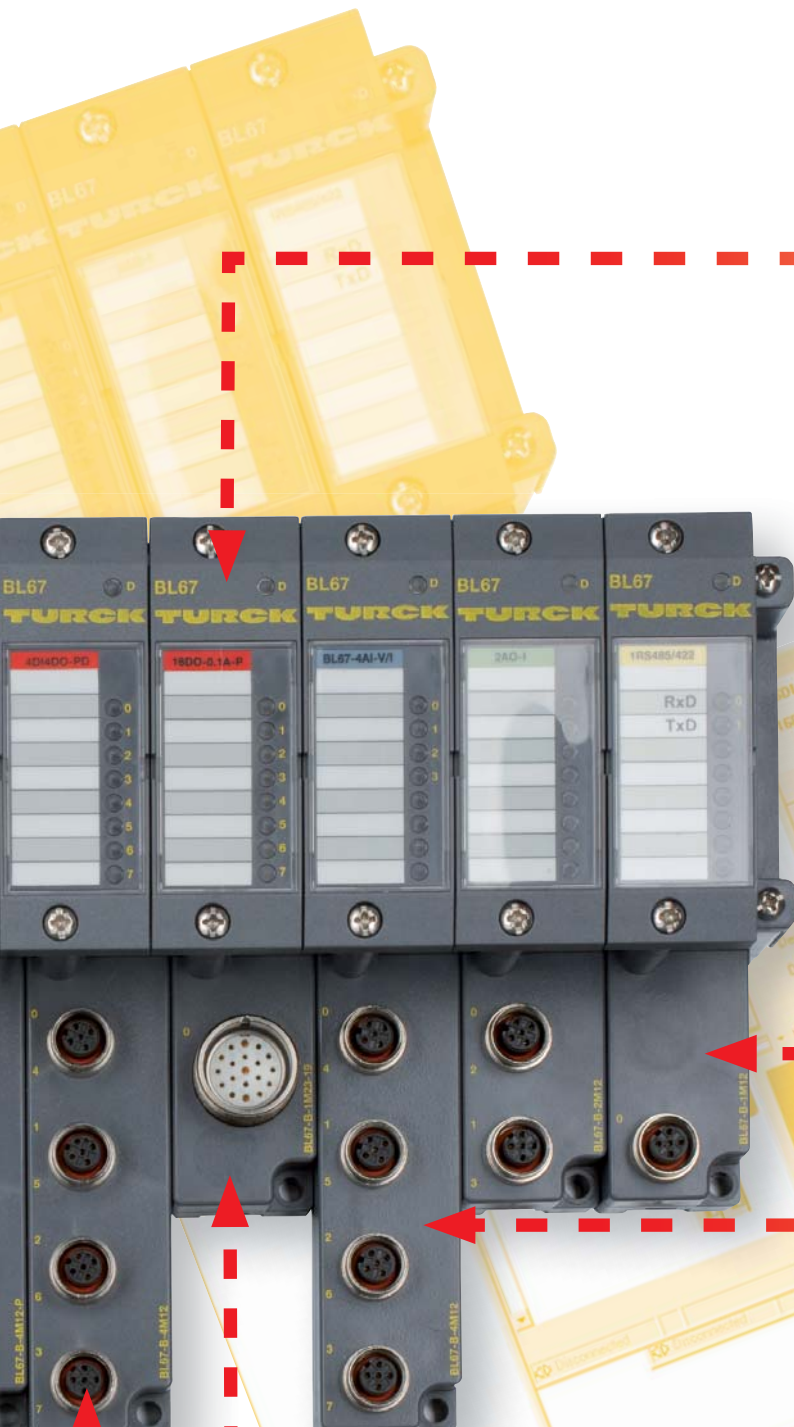

**Elektronic modules**

- Digital, analog, temperature, RS232, SSI, CANopen interface and more
- Independent form the applied fieldbus
- Free choice of connection technology
- Available as 2, 4, 8 or 16-channel version
- Local diagnostics and status display via LEDs
- Hot-Swapping function

**Base modules**

- Passive connection components for sensors and actuators
- Available as M8, M12, M23 and 7/8 connectors
- Connection of I/O modules with single, dual or multicore wiring
- Fast replacement of electronics through the use of separate connection bases

**Material recognition**

- Distinction of different metals or metallic compositions
- Distance independent material detection
- Inductive sensor with two analog voltage outputs

**Integration of valve terminals**

- 4, 8 or 16-channel digital output modules with M23 base modules for multipole valve terminals
- Up to 8 CANopen valve terminals with one CAN-valve interface connection module



**I/O-ASSISTANT**

- Planning, configuration, commissioning and diagnostic software
- Based on FDT/DTM technology
- Available as freeware on [www.turck.com](http://www.turck.com)

**CANopen**

**PROFI**  
PROCESS FIELD BUS  
**BUS**

**DeviceNet™**

## Easy programming with CoDeSys according to IEC 61131-3

The programmable gateways become decentral control units with the CoDeSys programming software.

The graphical programming interface supports all IEC-61131-3 programming languages

- Statement list ( STL)
- Ladder Diagram (LD)
- Continuous Function Chart (CFC)
- Structured Text (ST)
- Sequential Function Chart (AS)

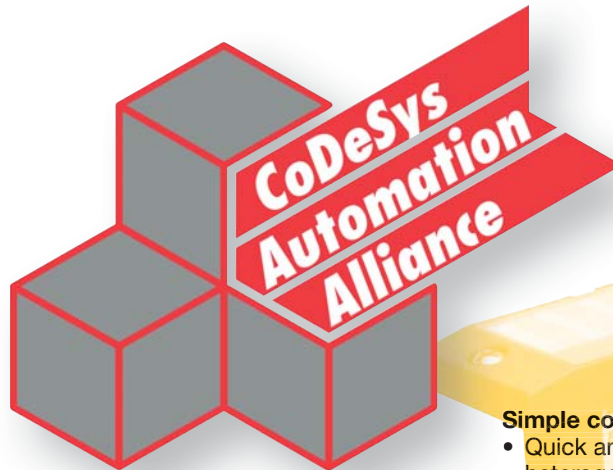

## Simple connection

- Quick and simple connection of heterogeneous systems
- Standard transmission protocols such as e.g. TCP/IP and UDP/IP
- Network-global variables
- Bidirectional data exchange between CoDeSys systems
- Additional programming is not required

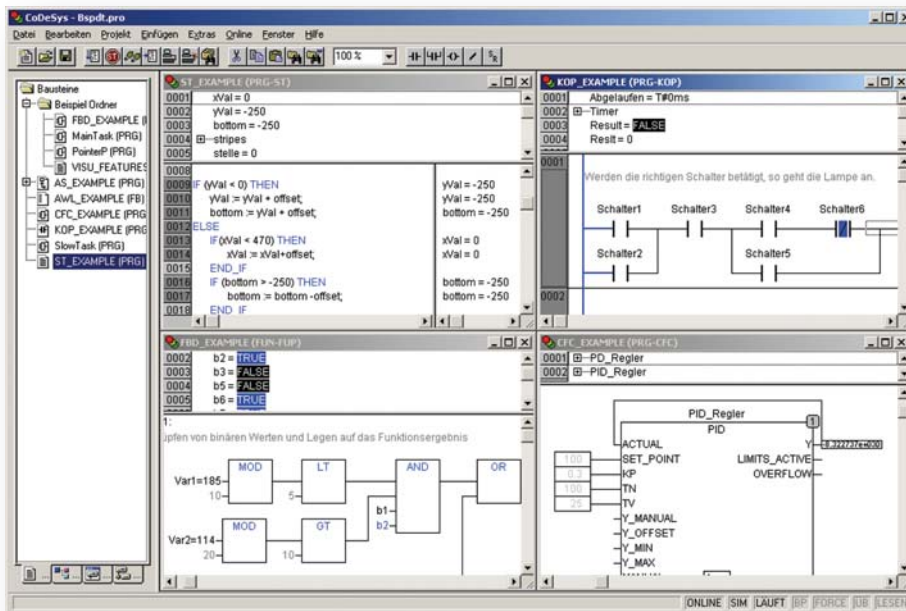

Data exchange via Ethernet

## Project planning and configuration

- Target-Support-Package as driver for the target system
- Drag and Drop function for the hardware configuration
- Standard editor for I/O configuration and parameterisation
- Symbolic display of variables for I/O addresses
- Numerous diagnostics and commissioning functions
- Funktion blocks e. g. for the RFID system *BL ident<sup>®</sup>*

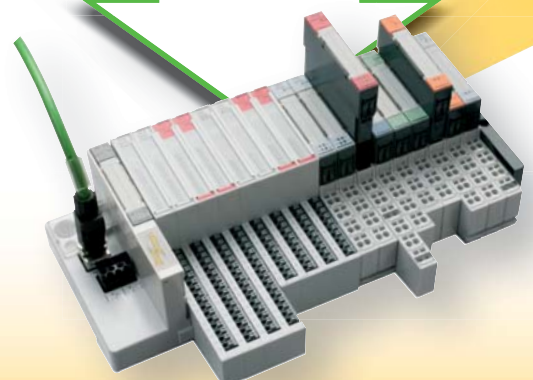



## Easy parameterisation with I/O-ASSISTANT on the basis of FDT/DTM

- System configuration, parameterisation and diagnostics with a graphical interface based on FDT/DTM technology
- DTMs can be integrated in any FDT frame application for configuration, commissioning and maintenance
- I/O-ASSISTANT and DTMs are available free of charge on [www.turck.com](http://www.turck.com)

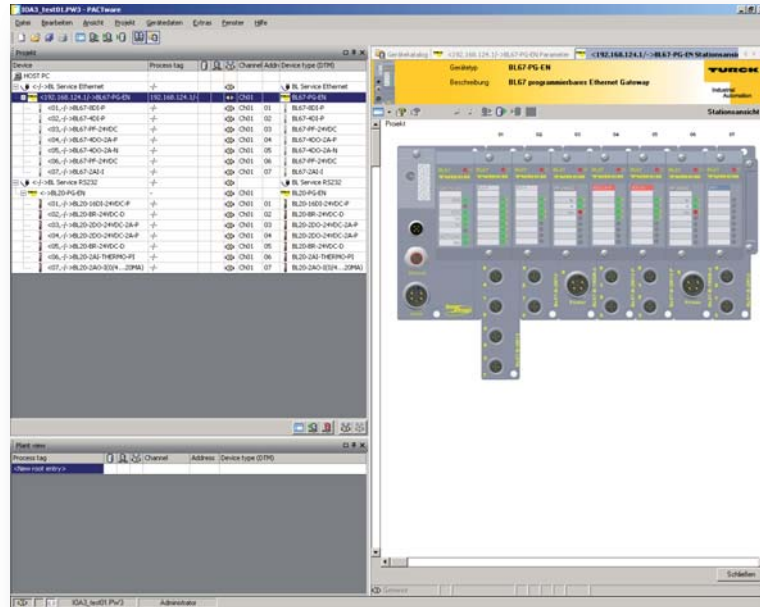

### Description

The configuration software I/O-ASSISTANT supports you in planning and implementation of an I/O system.

No matter if you are online or offline, the I/O-ASSISTANT simplifies the configuration as well as the configuration and parameterisation of the modules.

This software is also extremely helpful in system set-up and testing.

### Functions





- Supporting software tool
- Selection of the required modules
- Offline planning and configuration of BL67 modules
- Configuration, parameterisation and commissioning of individual modules
- Reading and setting of process data
- Commissioning help for testing the wiring and sensors without PLC
- Realistic display of configured BL67 components
- Automatic documentation of configured BL67 systems

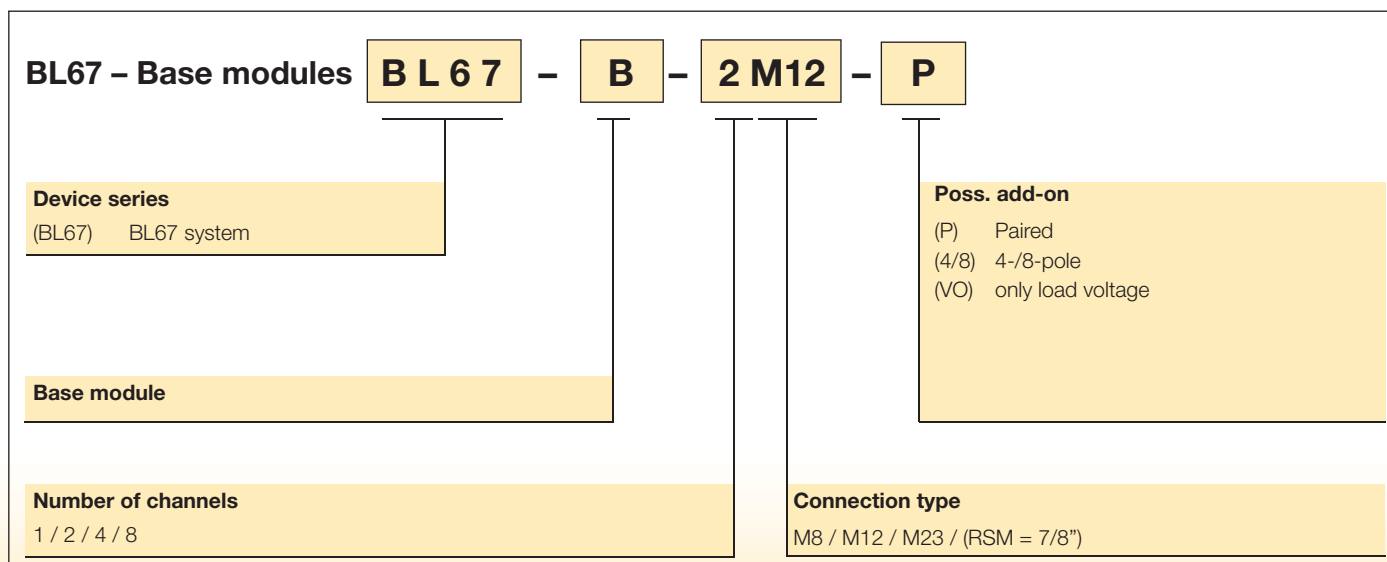
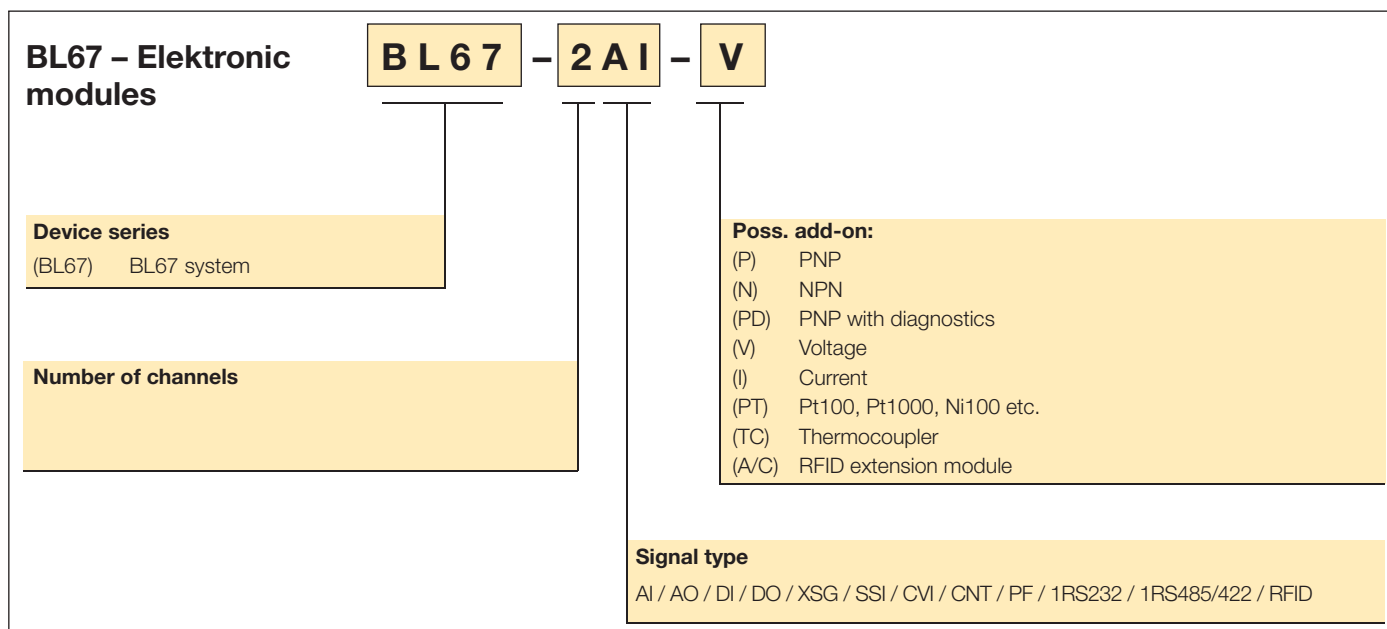
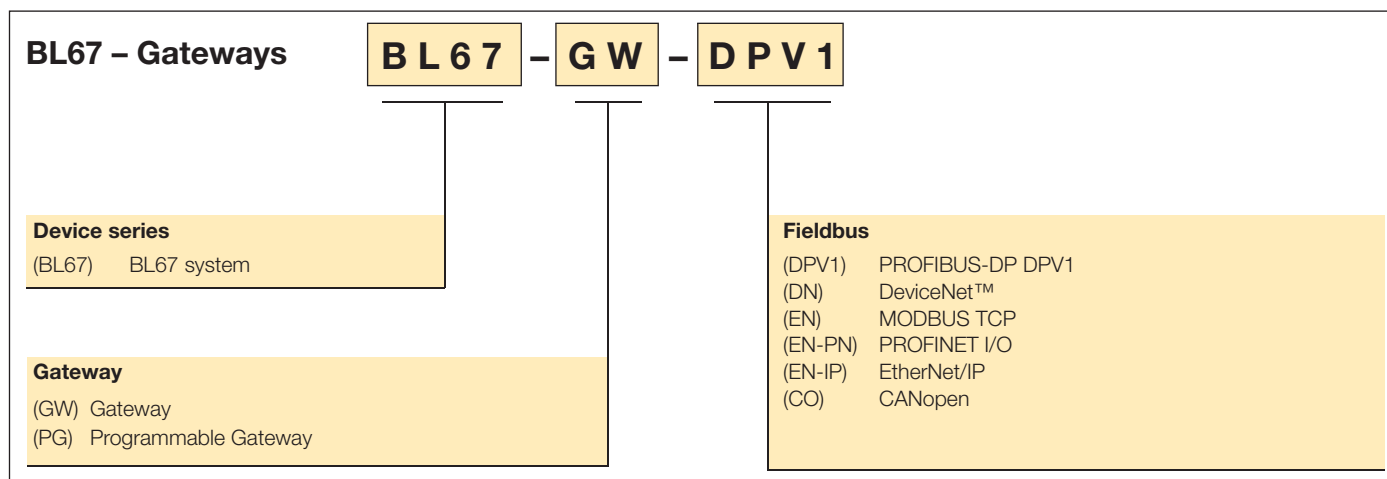

# BL67 – Type code



## BL67 – Base module BL67-B-...M12 and BL67-B-...M12-P – Process data mapping

BL67-B-2M12 6827186	BL67-B-2M12-P 6827194	BL67-B-4M12 6827187	BL67-B-4M12-P 6827195		BL67-B-2M12	BL67-B-2M12-P	BL67-B-4M12	BL67-B-4M12-P
				Connector 0, Pin 4 Connector 0, Pin 2	bit 0 bit 2	bit 0 bit 1	bit 0 bit 4	bit 0 bit 1
				Connector 1, Pin 4 Connector 1, Pin 2	bit 1 bit 3	bit 2 bit 3	bit 1 bit 5	bit 2 bit 3
				Connector 2, Pin 4 Connector 2, Pin 2	– –	– –	bit 2 bit 6	bit 4 bit 5
				Connector 3, Pin 4 Connector 3, Pin 2	– –	– –	bit 4 bit 7	bit 6 bit 7

# BL67 – Combination options

## Electronic modules and base modules

		Base modules														Page	
		Ident-no.															
		BL67-B-4M8	BL67-B-8M8	BL67-B-1M12	BL67-B-1M12-8	BL67-B-2M12	BL67-B-2M12-P	BL67-B-4M12	BL67-B-4M12-P	BL67-B-1M23	BL67-B-1M23-19	BL67-B-1RSM	BL67-B-1RSM-4	BL67-1RSM-VO			
<b>Power feeding modules</b>	<b>Ident-no.</b>																
BL67-PF-24VDC											✓	✓	✓				48
<b>Digital input modules</b>																	
BL67-4DI-P	6827171	✓			✓	✓	✓	✓	✓								50
BL67-8DI-P	6827170		✓						✓								52
BL67-4DI-PD	6827204	✓			✓	✓	✓	✓	✓ <sup>1</sup>								54
BL67-8DI-PD	6827205		✓				✓	✓	✓	✓ <sup>1</sup>							56
BL67-4DI-N	6827206	✓			✓	✓	✓	✓	✓	✓							58
BL67-8DI-N	6827207		✓				✓	✓	✓	✓							60
<b>Digital output modules</b>																	
BL67-4DO-0.5A-P	6827173	✓			✓	✓	✓	✓	✓								62
BL67-4DO-2A-P	6827174	✓			✓	✓	✓	✓	✓								64
BL67-8DO-0.5A-P	6827172		✓				✓	✓	✓								66
BL67-16DO-0.1A-P	6827221									✓							68
BL67-4DO-2A-N	6827210	✓			✓	✓	✓	✓	✓								70
BL67-8DO-0.5A-N	6827209		✓				✓	✓	✓								72
<b>Relay output modules</b>																	
BL67-8DO-R-NO	6827277							✓									74
<b>Digital input/output modules</b>																	
BL67-4DI4DO-PD	6827203		✓				✓	✓	✓ <sup>1</sup>								76
<b>Configurable digital input/output modules</b>																	
BL67-8XSG-PD	6827208		✓				✓	✓	✓ <sup>1</sup>								78

<sup>1</sup> I/O signals available, restricted diagnostic function

**Electronic modules and base modules**

		<b>Base modules</b>																<b>Page</b>										
		<b>Ident-no.</b>																										
		BL67-B-4M8	BL67-B-8M8	BL67-B-1M12	BL67-B-1M12-8	BL67-B-2M12	BL67-B-2M12-P	BL67-B-4M12	BL67-B-4M12-P	BL67-B-1M23	BL67-B-1M23-19	BL67-B-1RSM	BL67-B-1RSM-4	BL67-1RSM-VO	6827189	6827188	6827185	6827193	6827186	6827194	6827187	6827195	6827213	6827216	6827190	6827201	6827236	
<b>Analogue input modules</b>	<b>Ident-no.</b>																											
BL67-2AI-I	6827175				✓																							80
BL67-2AI-V	6827176				✓																							82
BL67-4AI-V/I	6827222						✓																					84
BL67-2AI-PT	6827177				✓																							86
BL67-2AI-TC	6827178				✓																							88
<b>Analogue output modules</b>																												
BL67-2AO-I	6827179				✓																							90
BL67-2AO-V	6827180				✓																							92
<b>Technology modules</b>																												
BL67-1RS232	6827181		✓	✓								✓																94
BL67-1RS485/422	6827192		✓	✓								✓	✓															96
BL67-1SSI	6827191			✓	✓							✓	✓															98
BL67-1CNT/ENC	6827224			✓								✓																100
BL67-1CVI	6827223		✓																									102
<b>BL ident® RFID modules</b>																												
BL67-2RFID-A	6827225				✓																							104
BL67-2RFID-C	6827238				✓																							106

# BL67 – Maximum system extension/System supply

## Maximum system extension

The maximum number of modules for extension depends on the respective system configuration. As the maximum current consumption of the modulbus should not exceed 1.5 A, the number of modules is restricted (see table Nominal current consumption, p.31) .

The use of modules with a high volume of process, parameter and diagnostic data might also impose restrictions to the extension of the system.

The I/O- ASSISTANT takes these aspects into account and issues a warning message if appropriate.

A BL67 system can be extended to a total length of 1 m, comprising of a gateway for PROFIBUS-DP, DeviceNet™/ CANopen or Ethernet and a maximum of 32 modules.

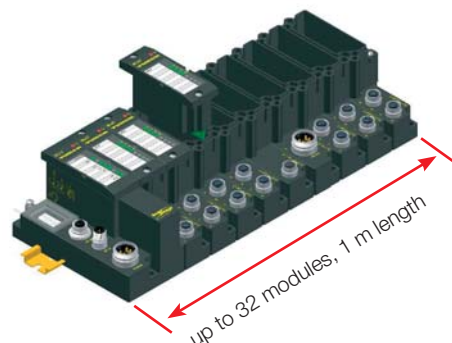

## Maximum system extension PROFIBUS-DP, DeviceNet™, CANopen

Module type	PROFIBUS <sup>®</sup>		DeviceNet <sup>™</sup>		CANopen	
	Number of chan.	Number of mod.	Number of chan.	Number of mod.	Number of chan.	Number of mod.
Digital inputs, 4 DI	128	32	128	32	128	32
Digital inputs 8 DI	256	32	256	32	256	32
Digital outputs 4 DO	128	32	128	32	128	32
Digital outputs 8 DO	256	32	256	32	256	32
Digital outputs, 16 DO	512	32	512	32	512	32
Analogue inputs, 2AI	64	32	64	32	64	32
Analogue inputs, 4AI	112	28	124	31	124	31
Analogue inputs, 2 AI-PT	56	28	64	32	64	32
Analogue inputs, 2 AI-TC	64	32	64	32	64	32
Analogue outputs, 2 AO-I	38	19	64	32	64	32
Analogue outputs, 2 AO-V	38	19	50	25	50	25

## System supply: General

The power supply for the BL67 system is either derived separately for PROFIBUS-DP and Ethernet gateways or directly from the DeviceNet™ / CANopen cable for the DeviceNet™ / CANopen gateway.

**Power-Feeding modules** can be inserted anywhere in the BL67 station. They provide isolated field voltage for the I/O modules mounted to their right. Thus Power-Feeding modules can also be used to create different potential groups.

## Maximum system extension Ethernet

Module type	Modbus TCP		EtherNet/IP <sup>™</sup>		PROFIBUS <sup>®</sup> INDUSTRIAL ETHERNET NETO	
	Number of chan.	Number of mod.	Number of chan.	Number of mod.	Number of chan.	Number of mod.
Digital inputs, 4 DI	128	32	128	32	128	32
Digital inputs 8 DI	256	32	256	32	256	32
Digital outputs 4 DO	128	32	128	32	128	32
Digital outputs 8 DO	256	32	256	32	256	32
Digital outputs, 16 DO	512	32	512	32	512	32
Analogue inputs, 2AI	64	32	64	32	64	32
Analogue inputs, 4AI	128	32	128	32	128	32
Analogue inputs, 2 AI-PT	64	32	64	32	64	32
Analogue inputs, 2 AI-TC	64	32	64	32	64	32
Analogue outputs, 2 AO-I	64	32	64	32	64	32
Analogue outputs, 2 AO-V	50	25	50	25	50	25

## System supply via the module bus

The number of BL67 modules, which can be powered via the internal module bus, depends on the nominal current rating  $I_{MB}$  of the individual modules on the module bus. The total current consumption of the installed BL67 modules may not exceed 1.5 A.

When using the software I/O-ASSISTANT, the menu item <Station - Verify> will automatically generate an error message if the system supply via the module bus is not reliably ensured.

## Nominal current consumption

The following table shows the nominal current consumption  $I_{MB(5V)}$  of the various BL67 modules on the module bus, the resulting nominal current consumption  $I_{MB(24V)}$  of the modules via the 24 VDC supply and the nominal current consumption  $I_I$  or  $I_O$  of the modules via the supply:

Modules	Nom. current module bus $I_{MB(5V)}^{1)}$	Nom. current module bus $I_{MB(24V)}^{2)}$	$I_{ges.}^{5)}$	
			Nom. current input module $I_I^{3)}$	Nom. current Output module $I_O^{4)}$
Gateway PROFIBUS-DP	–	≤ 150 mA		
Gateway DeviceNet™	–	≤ 150 mA		
Gateway CANopen	–	≤ 150 mA		
Gateway Ethernet	–	≤ 150 mA		
BL67-PF-24VDC	≤ 30 mA	≤ 9 mA		
BL67-4DI-P	≤ 30 mA	≤ 9 mA	≤ 40 mA	
BL67-4DI-N	≤ 30 mA	≤ 9 mA	≤ 1 mA	
BL67-4DI-PD	≤ 30 mA	≤ 9 mA	≤ 100 mA	
BL67-8DI-P	≤ 30 mA	≤ 9 mA	≤ 40 mA	
BL67-8DI-N	≤ 30 mA	≤ 9 mA	≤ 1 mA	
BL67-8-DI-PD	≤ 30 mA	≤ 9 mA	≤ 100 mA	
BL67-4DO-0.5A-P	≤ 30 mA	≤ 9 mA		≤ 100 mA (Load current = 0)
BL67-4DO-2A-P	≤ 30 mA	≤ 9 mA		≤ 100 mA (Load current = 0)
BL67-4DO-2A-N	≤ 30 mA	≤ 9 mA		≤ 100 mA (Load current = 0)
BL67-8DO-0.5A-P	≤ 30 mA	≤ 9 mA		≤ 100 mA (Load current = 0)
BL67-8DO-0.5A-N	≤ 30 mA	≤ 9 mA		≤ 100 mA (Load current = 0)
BL67-16DO-0.1A-P	≤ 30 mA	≤ 9 mA		≤ 100 mA (Load current = 0)
BL67-4DI4DO-PD	≤ 30 mA	≤ 9 mA		≤ 100 mA (Load current = 0)
BL67-8XSG-PD	≤ 30 mA	≤ 9 mA		≤ 100 mA (Load current = 0)
BL67-8DO-R-NO	≤ 30 mA	≤ 9 mA		≤ 100 mA (Load current = 0)
BL67-2AI-V	≤ 35 mA	≤ 10 mA	≤ 12 mA	
BL67-2AI-I	≤ 35 mA	≤ 10 mA	≤ 12 mA	
BL67-4AI-I/V	≤ 35 mA	≤ 10 mA	≤ 12 mA	
BL67-2AI-TC	≤ 35 mA	≤ 10 mA	≤ 30 mA	
BL67-2AI-PT	≤ 45 mA	≤ 13 mA	≤ 45 mA	
BL67-2AO-I	≤ 40 mA	≤ 12 mA		≤ 50 mA
BL67-2AO-V	≤ 60 mA	≤ 17 mA		≤ 50 mA
BL67-1RS232	≤ 140 mA	≤ 40 mA	≤ 50 mA	
BL67-1RS485/422	≤ 60 mA	≤ 17 mA	≤ 25 mA	
BL67-1SSI	≤ 50 mA	≤ 14 mA	≤ 25 mA	
BL67-1CNT/ENC	≤ 30 mA	≤ 9 mA	≤ 100 mA	
BL67-1CVI	≤ 30 mA	≤ 9 mA	≤ 100 mA	

1) The nominal current consumption via the 5 VDC system supply may not exceed 1.5 A. The primary product of  $V_{MB(24V)}$  and  $I_{MB(24V)}$  accords to the secondary product of  $V_{MB(5V)}$  and  $I_{MB(5V)}$ . Power losses have not been considered.

2) The nominal current consumption via the 24 VDC field supply.

3) Is limited to 4 A by means of the integrated short-circuit protection.

4) The nominal current consumption via the field supply: with PROFIBUS-DP it may not exceed 10 A and with DeviceNet™ 8 A.

5)  $I_{total} = \Sigma I_{MB(24V)} + \Sigma I_I + \Sigma I_O$

# BL67 – Power supply concept

## PROFIBUS-DP/CANopen/Ethernet system

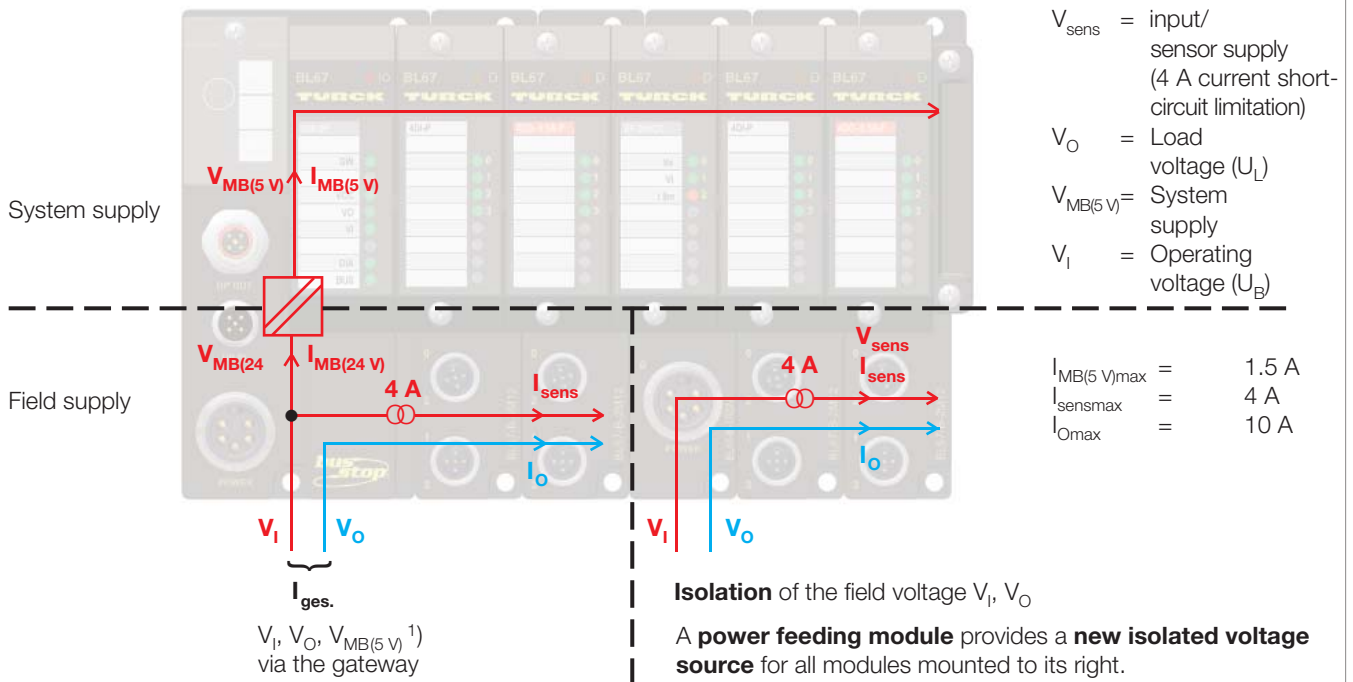

## DeviceNet™ system

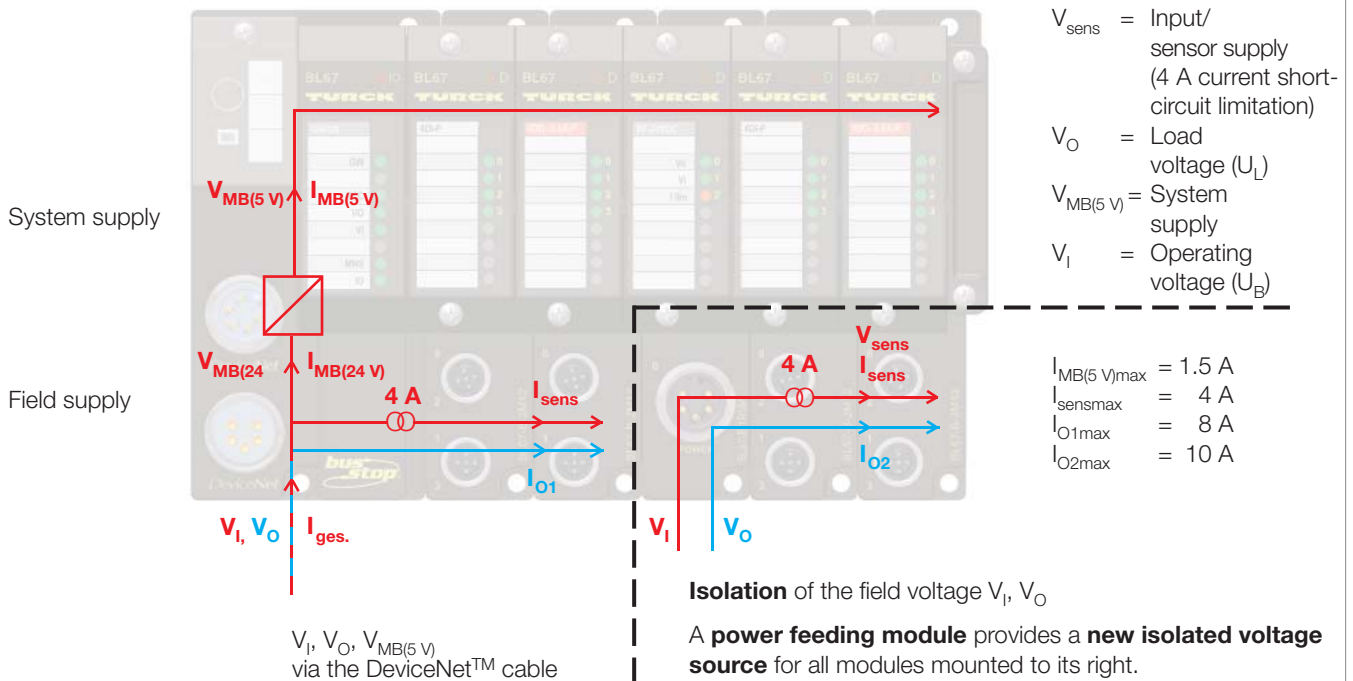

1)  $V_{MB(5V)}$  is galvanically isolated from the supply.  $V_I$  and  $V_O$  are not galvanically isolated and use a common GND potential.



**Power feeding module BL67-PF-24VDC with base module BL67-B-1RSM**

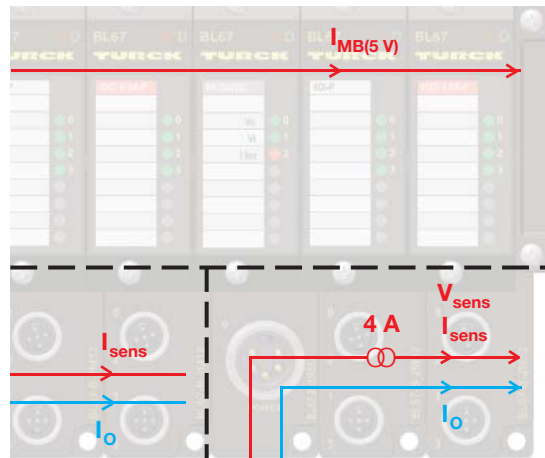

$V_{sens}$  = Input/sensor supply (4 A current short-circuit limitation)  
 $V_O$  = Load voltage ( $U_L$ )  
 $V_I$  = Operating voltage ( $U_B$ )

$I_{MB(5V)max} = 1.5 A$   
 $I_{sensmax} = 4 A$   
 $I_{Omax} = 10 A$

**Isolation** of the field voltage  $V_I$ ,  $V_O$

A **power feeding module** provides a **new isolated voltage source** for all modules mounted to its right.

**Power feeding module BL67-PF-24VDC with base module BL67-B-1RSM-4**

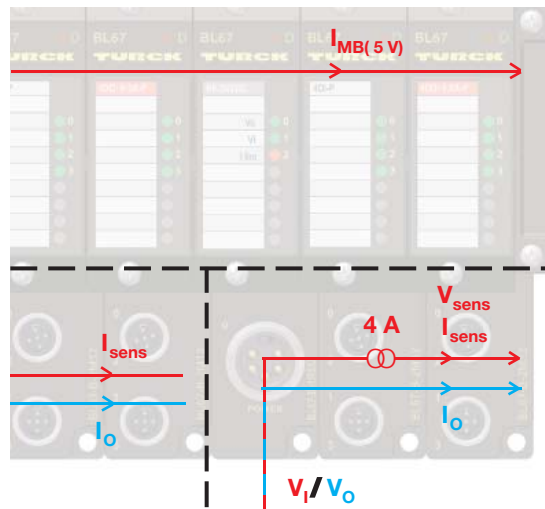

$V_{sens}$  = Input/sensor supply (4 A current short-circuit limitation)  
 $V_O$  = Load voltage ( $U_L$ )  
 $V_I$  = Operating voltage ( $U_B$ )

$I_{MB(5V)max} = 1.5 A$   
 $I_{sensmax} = 4 A$   
 $I_{Omax} = 10 A$

**Power feeding module BL67-PF-24VDC with base module BL67-B-1RSM-VO**

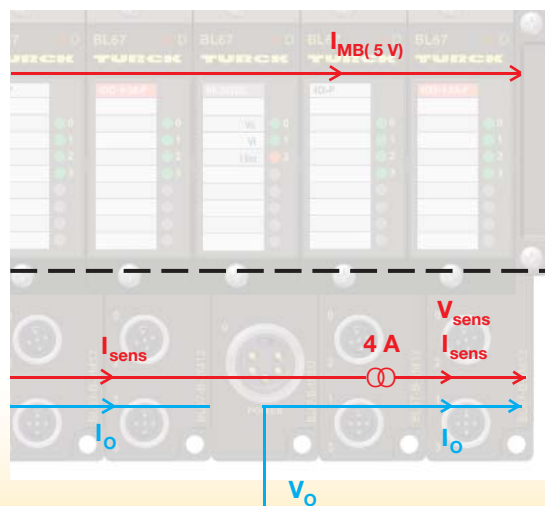

$V_{sens}$  = Input/sensor supply (4 A current short-circuit limitation)  
 $V_O$  = Load voltage ( $U_L$ )  
 $V_I$  = Operating voltage ( $U_B$ )

$I_{MB(5V)max} = 1.5 A$   
 $I_{sensmax} = 4 A$   
 $I_{Omax} = 10 A$

# BL67 – General technical data

## Dimensions and mounting holes

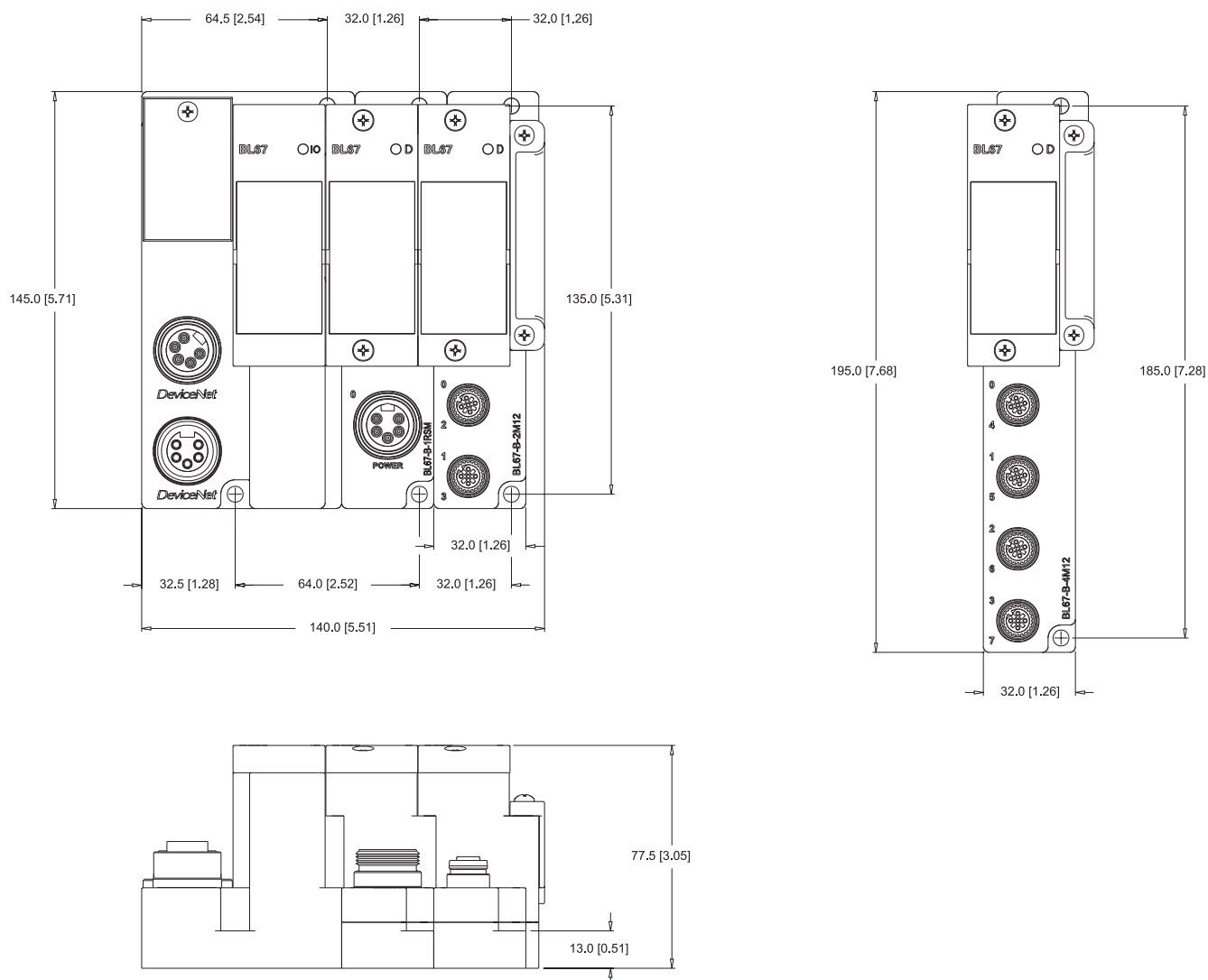

### Note:

Extended vibration resistance:

- Max. 5 g when mounted on non-perforated DIN rail acc. to EN 60715, with end brackets
- Max. 20 g when mounted on a base plate or directly on the machine. At least the gateway and each second module has to be fixed with two screws.

**General technical data**

**BL67 general data**

Potential isolation	via opto-coupler
Ambient temperature	
- Operating temperature	-25 ... +70 °C ( possible function limitation of single modules < 0 °C or > 55 °C, see module description)
- Storage temperature	-25 up to +85 °C
Relative humidity	5 up to 95 % (inside), level RH-2, no condensation (at 45 °C storage temperature)
Schadgas	acc. to IEC 60068-2-42/43
- SO <sub>2</sub>	10 ppm (rel. humidity < 75 %, no condensation)
- H <sub>2</sub> S	1.0 ppm (rel. humidity < 75 %, no condensation)
Vibration resistance	according to EN 61131
- 10 to 57 Hz, constant amplitude 0,075 mm, 1 g	yes
- 57 to 150 Hz, constant acceleration 1 g	yes
- Vibration mode	frequency cycles with a change rate of 1 octave/min
- Vibration duration	20 frequency cycles per coordinate axis
Extended vibration resistance	(gateways VN 02-00)
- up to 5 g (between 10 and 150 Hz)	mounting on non-perforated DIN rail acc. to EN 60715, with end brackets
- up to 20 g (between 10 and 150 Hz)	firm mounting on base plate or machine. Each second module has to be fixed with two screws.
Application conditions	according to EN 61131
Shock resistance	according to IEC 68-2-27, 18 shocks, semi-sinusoidal 15 g threshold/11 ms, each in ±-direction per space coordinate
Repetitive shock resistance	according to IEC 68-2-29, 1000 shocks, semi-sinusoidal 25 g threshold/6 ms, each in ±-direction per space coordinate
Drop and topple	according to IEC 68-2-31 and free fall according to IEC 68-2-32
- Drop height (weight < 10 kg)	1.0 m
- Drop height (weight 10 to 40 kg)	0.5 m
- Test cycles	7
Protection degree	IP67
Electromagnetic capability (EMC)	according to EN 61131-2/EN 50082-2 (Industrial)
- Static electricity according to EN 61000-4-2	
- Air discharge (direct)	8 kV
- Relay discharge (indirect)	4 kV
Housing material	PC-V0 (Lexan)
<b>Approvals</b>	CE
	cUL

**i** The I/O system BL67 does not require mounting in an extra housing. It was specially designed for harsh industrial environments and for direct mounting on the machine and in the process. The system is extremely robust and protected against dirt, dust and most liquids through its high degree of protection. However, it is not suited for the following applications: high pressure jet cleaning, 100% humidity, outdoor installation or permanent operation in liquids.

# BL67 – Specific accessories

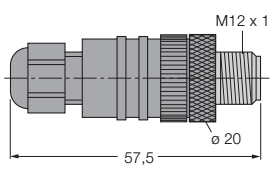
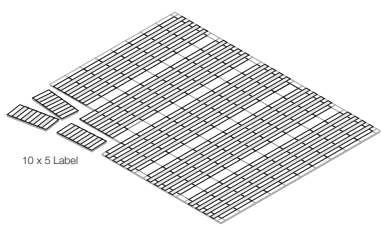
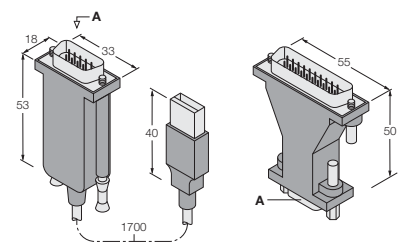
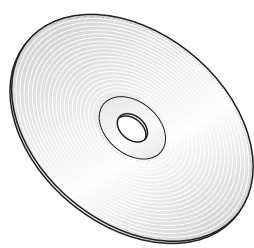
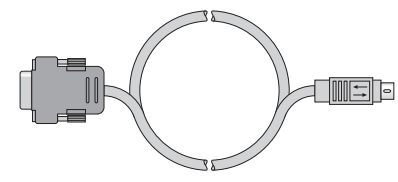
Fig.	Description	Type	Ident. no
	For BL67-2AI-TC, M12 x 1 round connector, field wirable, screw-terminal connection, integrated Pt1000 sensor for cold junction point compensation	<b>BL67-WAS5-THERMO</b>	6827197
	for labelling of the BL67 electronic modules, DIN A4 standard paper size, perforated, 50 labels, suited for laser printers	<b>BL67-LABEL-DIN-A4-50 pcs.</b>	6827196
	adapter cable USB to RS232, serial adapter SUB-D 9-pole to SUB-D 25-pole included in delivery, driver for Microsoft® 98, ME, 2000, XP, cable length 1.7 m	<b>USB-2-RS232</b>	6900426
	Planning, configuration, commissioning and diagnostic freeware for modular Fieldbus I/O systems  Download on <a href="http://www.turck.com">http://www.turck.com</a>	<b>I/O-ASSISTANT</b>	–
	RS232 adapter cable for connection of the I/O ASSISTANT, 9-pole SUB-D female connector, cable length 2,5 m	<b>I/O-ASSISTANT-Kabel-BL20/BL67</b>	6827133



## User manuals

The user manuals for BL67 systems are only available as PDF file and can be downloaded on [www.turck.com](http://www.turck.com)

## Gateway

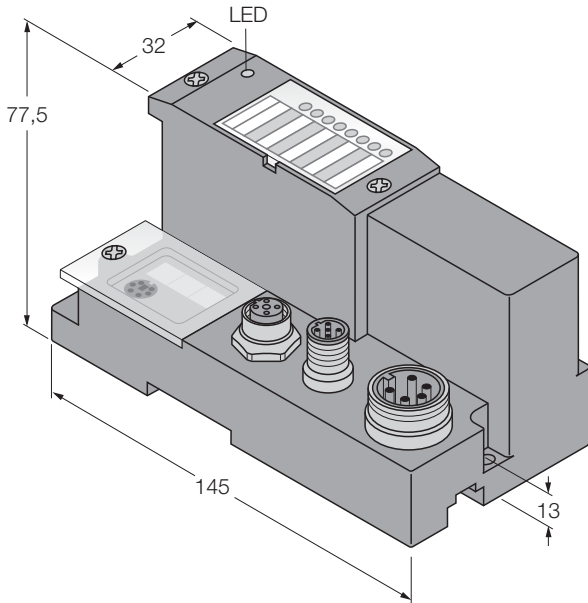

BL67 gateways are the heart of a BL67 station. They are designed to connect the modular fieldbus nodes to the higher level fieldbus (PROFIBUS-DP, DeviceNet™, CANopen, Ethernet).

All BL67 electronic modules communicate over the internal module bus with the gateway. The gateway structures the data and sends them clustered via fieldbus nodes to the higher control system. This way all I/O modules can be configured independently of the bus system.

## Elektronic module

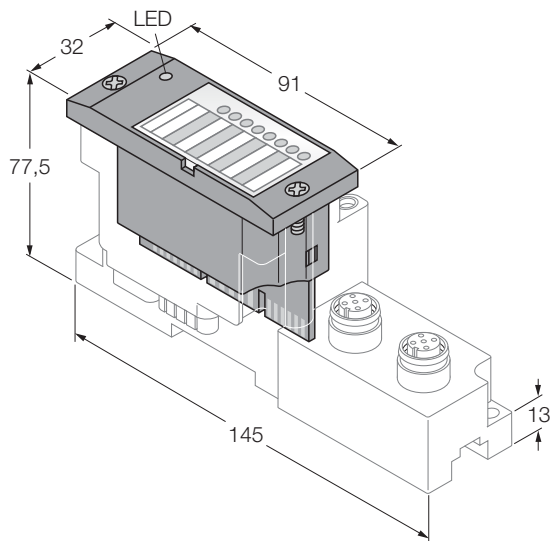

BL67 electronic modules are inserted into the passive base modules from above and then simply affixed with two screws. Maintenance is extremely simplified due to the separation of connection level and module electronics. Moreover, flexibility is enhanced because the base modules provide different types of connectors.

Voltage supply for the electronic modules is either provided via the gateway or a Power-Feeding module. Power-Feeding modules can be used to create galvanically isolated potential groups.

## Base module

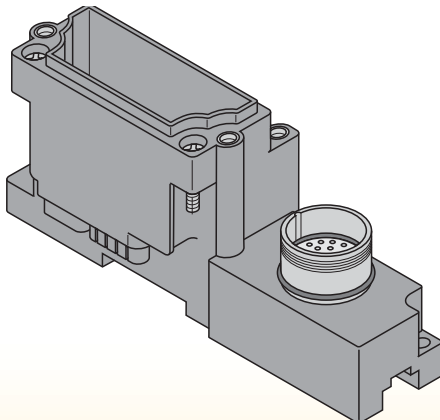

BL67 base modules are aligned one by one to the right of the gateway and are tightened each with two screws, either with the gateway or with the previous module. A DIN rail is not required. This way a compact and stable unit is created which can be mounted directly on the machine or on a DIN-rail.

The base modules serve for connection of the field devices and are available with different connection types (M8, M12, M23 und 7/8").

# Gateway for BL67 I/O system

## Interface for PROFIBUS-DP

### BL67-GW-DPV1

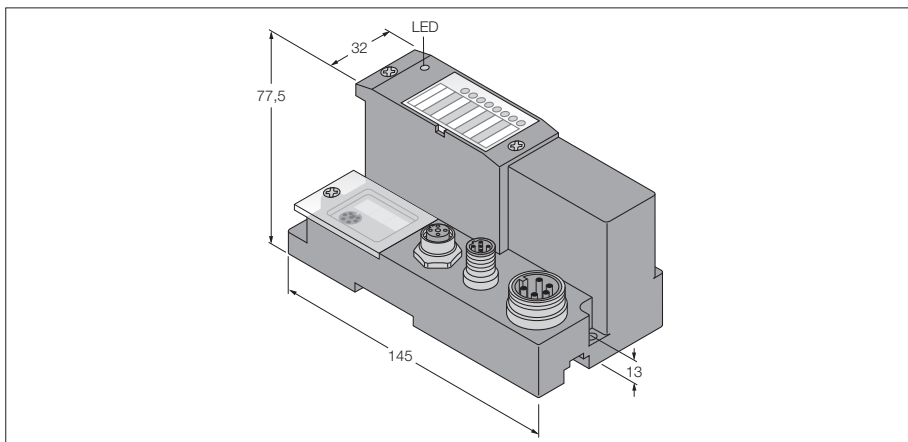

- 3 decimally coded rotary switches
- Degree of protection IP67
- LEDs for display of supply voltage, common alarm and bus errors
- Interface between the BL67 system and PROFIBUS-DPV0/DPV1
- 12 Mbps
- Two 5-pole reverse-keyed M12 x 1 connectors for fieldbus connection
- One 5-pole 7/8" connector for power connection

<b>Type</b>	BL67-GW-DPV1
Ident-No.	6827232
<b>Supply voltage</b>	24 VDC
Admissible range	18...30 VDC
Rated current from module bus	≤ 650 mA
Max. field supply current	10 A
Max. system supply current	1.5 A
Voltage supply connection	5-pole male 7/8" connector
<b>Fieldbus transmission rate</b>	9.6 kbps up to 12 Mbps
Fieldbus addressing range	1...125
Fieldbus addressing	3 decimally coded rotary switches
Service interface	RS232 interface (PS/2 socket)
Fieldbus connection technology	2 x M12, 5-pole, inversely coded
Voltage supply connection	5-pole male 7/8" connector
Fieldbus connection	external
<b>Operating temperature</b>	-25...+70 °C
Function degrading operating temperature	
> 55 °C circulating air (ventilation)	no limitation
> 55 °C steady ambient air	Isens < 3A, Imb < 1A
<b>General technical data</b>	see page 35

#### Accessories

<b>6915769</b> RKSU-D9T451-2M	Profibus cable M12 to sub-D
<b>6601590</b> RSS4.5-PDP-TR	Profibus M12 terminating resistor
<b>6914145</b> RKM52-6M	power cable 7/8" unterminated end

#### Profibus DP OUT

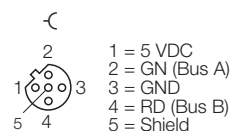

#### Profibus DP IN

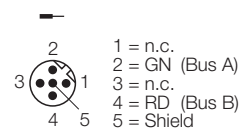

#### Voltage supply

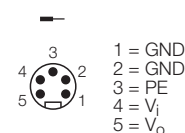

**Gateway for BL67 I/O system  
Interface for DeviceNet  
BL67-GW-DN**

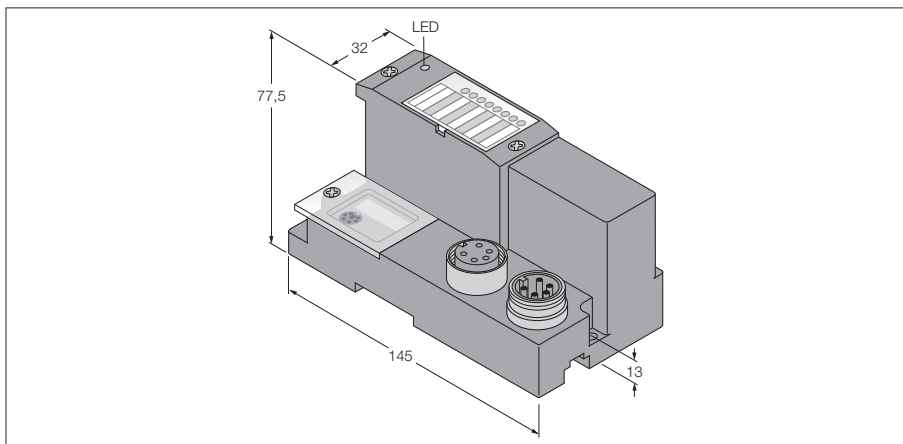

- 3 decimally coded rotary switches
- Degree of protection IP67
- LEDs for display of supply voltage, common alarm and bus errors
- Interface between the BL67 system and DeviceNet™
- 120 / 250 / 500 kbps
- Two 5-pole 7/8" connectors for fieldbus connection

2

<b>Type</b>	BL67-GW-DN
Ident-No.	6827183
<b>Supply voltage</b>	24 VDC
Admissible range	11...26 VDC
Rated current from module bus	≤ 600 mA
Max. field supply current	8 A
Max. system supply current	1.5 A
Voltage supply connection	via DeviceNet cable
<b>Fieldbus transmission rate</b>	125 kbps to 500 kbps
Fieldbus addressing range	0...63
Fieldbus addressing	2 decimally coded rotary switches
Service interface	RS232 interface (PS/2 socket)
Fieldbus connection technology	2 x 7/8", 5-pole
Voltage supply connection	via DeviceNet cable
Fieldbus connection	external
<b>Operating temperature</b>	-25...+70 °C
<b>General technical data</b>	see page 35

**DeviceNet™ OUT**

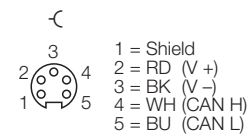

**DeviceNet™ IN**

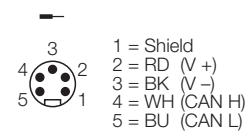

**Accessories**

- 6605189** RKM5723-6M DeviceNet cable 7/8" connector to unterminated at end
- 6605553** RSM-RKM5723-6M DeviceNet cable 7/8" plug to connector
- 6602011** RSM57-TR2 DeviceNet 7/8" terminating resistor

# Gateway for BL67 I/O system

## Interface for CANopen

### BL67-GW-CO

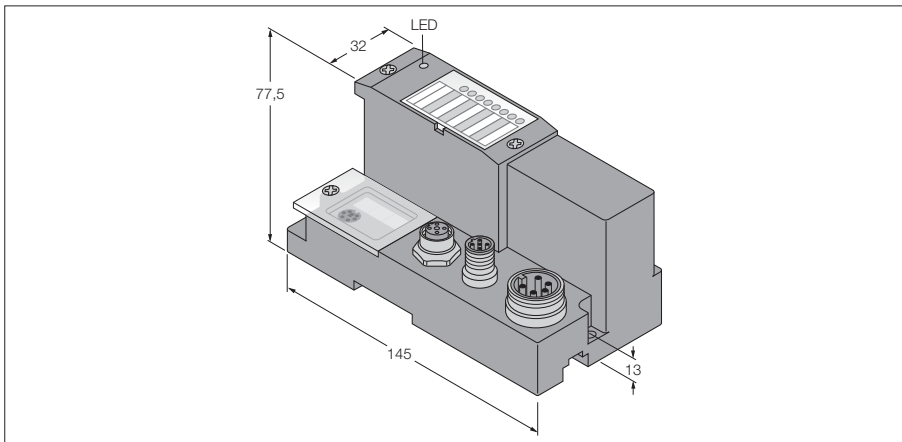

- 3 decimally coded rotary switches
- Degree of protection IP67
- LEDs for display of supply voltage, common alarm and bus errors
- Interface between the BL67 system and CANopen
- 1 Mbps
- Two 5-pole M12 connectors for fieldbus connection
- One 5-pole 7/8" connector for power connection

<b>Type</b>	BL67-GW-CO
Ident-No.	6827200
<b>Supply voltage</b>	24 VDC
Admissible range	18...30 VDC
Rated current from module bus	≤ 600 mA
Max. field supply current	10 A
Max. system supply current	1.5 A
Voltage supply connection	5-pole male 7/8" connector
<b>Fieldbus transmission rate</b>	10 kbps up to 1 Mbps
Fieldbus addressing range	1...99
Fieldbus addressing	2 decimally coded rotary switches
Service interface	RS232 interface (PS/2 socket)
Fieldbus connection technology	2 x M12, 5-pole
Voltage supply connection	5-pole male 7/8" connector
Fieldbus connection	external
<b>Operating temperature</b>	-25...+70 °C
Function degrading operating temperature	
> 55 °C circulating air (ventilation)	no limitation
> 55 °C steady ambient air	Isens < 3A, Imb < 1A
<b>General technical data</b>	see page 35

#### CANopen OUT

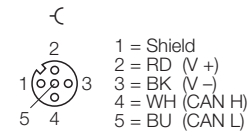

#### CANopen IN

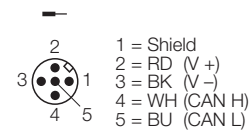

#### Voltage supply

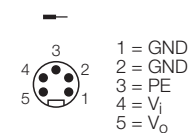

#### Accessories

<b>6603624</b> RKC572-6M	CANopen cable M12 female connector with unterminated end
<b>6602308</b> RSE57-TR2	CANopen M12 terminating resistor
<b>6914145</b> RKM52-6M	power cable 7/8" unterminated end



**Gateway for BL67 I/O system  
Interface for CANopen  
BL67-GW-CO-T**

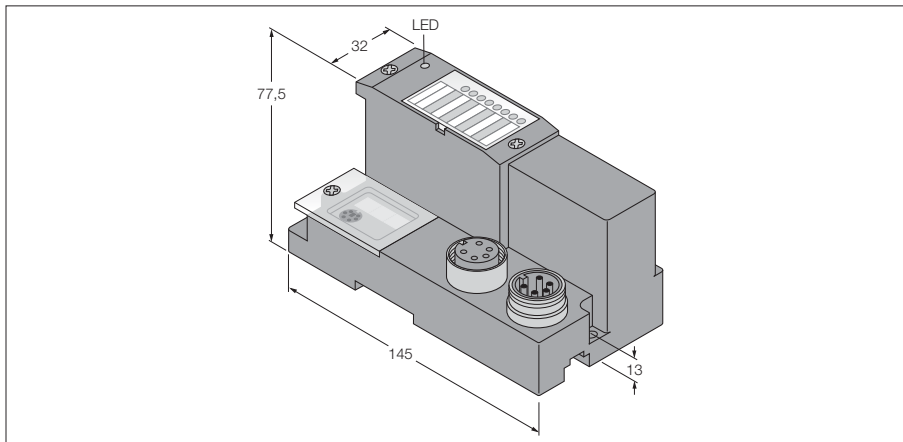

- 3 decimally coded rotary switches
- Degree of protection IP67
- LEDs for display of supply voltage, common alarm and bus errors
- Interface between the BL67 system and CANopen
- 1 Mbps
- Two 5-pole 7/8" connectors for fieldbus connection

2

<b>Type</b>	BL67-GW-CO-T
Ident-No.	6827289
<b>Supply voltage</b>	24 VDC
Admissible range	18...30 VDC
Rated current from module bus	≤ 600 mA
Max. field supply current	10 A
Max. system supply current	1.5 A
Voltage supply connection	CAN cable
<b>Fieldbus transmission rate</b>	10 kbps up to 1 Mbps
Fieldbus addressing range	1...99
Fieldbus addressing	2 decimally coded rotary switches
Service interface	RS232 interface (PS/2 socket)
Fieldbus connection technology	2 x 7/8", 5-pole
Voltage supply connection	CAN cable
Fieldbus connection	external
<b>Operating temperature</b>	-25...+70 °C
Function degrading operating temperature	
> 55 °C circulating air (Ventilation)	no limitation
> 55 °C steady ambient air	Isens < 3A, I <sub>mb</sub> < 1A
<b>General technical data</b>	see page 35

**CANopen OUT**

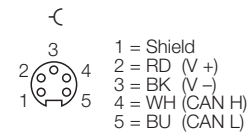

**CANopen IN**



**Accessories**

<b>6605189</b> RKM5723-6M	DeviceNet cable 7/8" connector to unterminated at end
<b>6605553</b> RSM-RKM5723-6M	DeviceNet cable 7/8" plug to connector
<b>6602011</b> RSM57-TR2	DeviceNet 7/8" terminating resistor

# Gateway for BL67 I/O system

## Interface for MODBUS TCP

### BL67-GW-EN

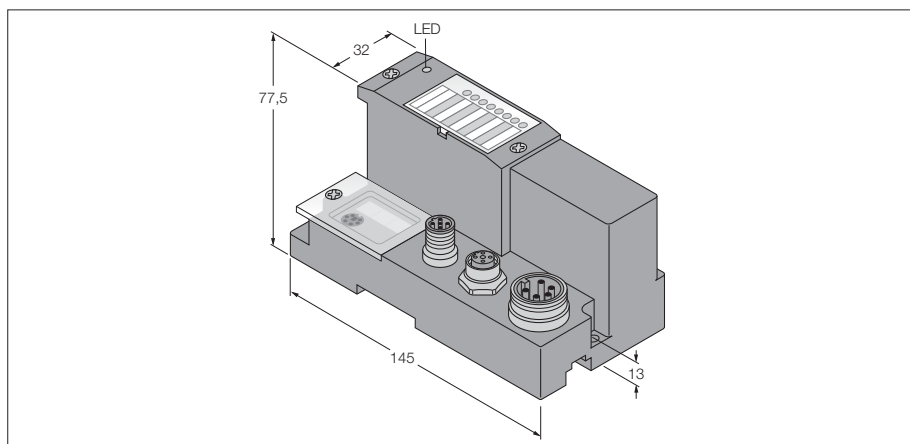

- 3 decimally coded rotary switches
- Degree of protection IP67
- LEDs for display of supply voltage, common alarm and bus errors
- Interface between the BL67 system and MODBUS TCP
- 10/100 Mbps
- One 4-pole M12 connector, D coding, for fieldbus connection
- One 5-pole 7/8" connector for power connection

<b>Type</b>	BL67-GW-EN
Ident-No.	6827214
<b>Supply voltage</b>	24 VDC
Admissible range	18...30 VDC
Rated current from module bus	≤ 600 mA
Max. field supply current	10 A
Max. system supply current	1.5 A
Voltage supply connection	5-pole male 7/8" connector
<b>Fieldbus transmission rate</b>	10/100 Mbps
Fieldbus addressing	rotary switch, BOOTP, DHCP, IO-ASSISTANT
Service interface	RS232 interface (PS/2 socket)
Fieldbus connection technology	female M12 x 1 connector, 4-pole, D-coded
Voltage supply connection	5-pole male 7/8" connector
<b>Operating temperature</b>	-25...+70 °C
Function degrading operating temperature	
> 55 °C circulating air (ventilation)	no limitation
> 55 °C steady ambient air	Isens < 3A, Imb < 1A

**General technical data** see page 35

#### Accessories

<b>6914219</b>	RSSD-RSSD-441-6M/S2174	Ethernet cable M12 to M12 (4-pole, D-coded)
<b>6915781</b>	RSSD-RJ45-441-2M/S2174	Ethernet cable RJ45 to M12 (4-pole, D-coded)
<b>6914145</b>	RKM52-6M	power cable 7/8" unterminated end

#### Without function

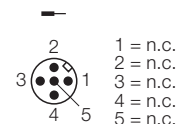

#### Ethernet

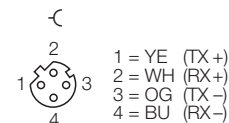

#### Voltage supply

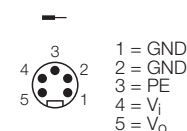

**Gateway for BL67 I/O system  
Interface for PROFINET IO  
BL67-GW-EN-PN**

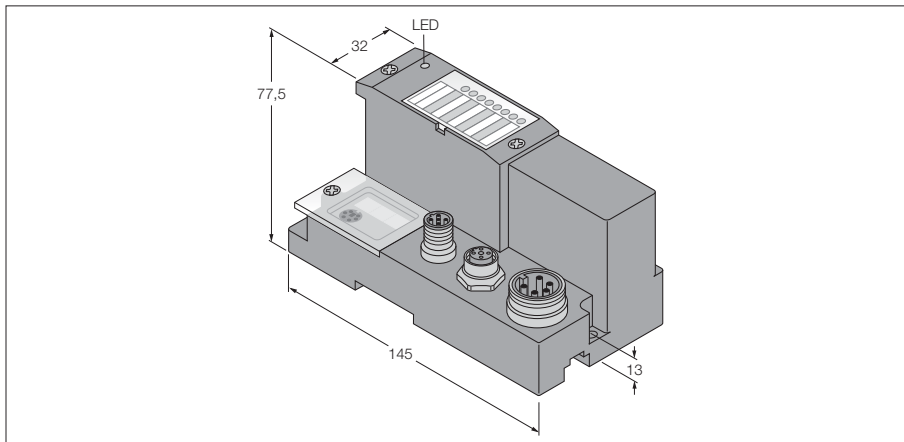

- 3 decimally coded rotary switches
- Degree of protection IP67
- LEDs for display of supply voltage, common alarm and bus errors
- Interface between BL67 system and PROFINET IO
- 10/100 Mbps
- One 4-pole M12 connector, D coding, for fieldbus connection
- One 5-pole 7/8" connector for power connection

2

<b>Type</b>	BL67-GW-EN-PN
Ident-No.	6827228
<b>Supply voltage</b>	24 VDC
Admissible range	18...30 VDC
Rated current from module bus	≤ 600 mA
Max. field supply current	10 A
Max. system supply current	1.5 A
Voltage supply connection	5-pole male 7/8" connector
<b>Fieldbus transmission rate</b>	10/100 Mbps
Fieldbus addressing	PROFINET conform, rotary switch, BOOTP, DHCP, IO-ASSISTANT
Service interface	RS232 interface (PS/2 socket)
Fieldbus connection technology	female M12 x 1 connector, 4-pole, D-coded
Voltage supply connection	5-pole male 7/8" connector
<b>Operating temperature</b>	-25...+70 °C
Function degrading operating temperature	
> 55 °C circulating air (ventilation)	no limitation
> 55 °C steady ambient air	Isens < 3A, I <sub>mb</sub> < 1A
<b>General technical data</b>	see page 35

**Without function**

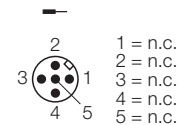

**Ethernet**

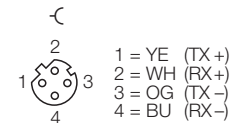

**Voltage supply**

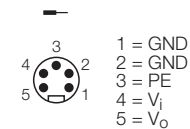

**Accessories**

- 6914219** RSSD-RSSD-441-6M/S2174 Ethernet cable M12 to M12 (4-pole, D-coded)
- 6915781** RSSD-RJ45-441-2M/S2174 Ethernet cable RJ45 to M12 (4-pole, D-coded)
- 6914145** RKM52-6M power cable 7/8" unterminated end

# Gateway for BL67 I/O system

## Interface for EtherNet/IP

### BL67-GW-EN-IP

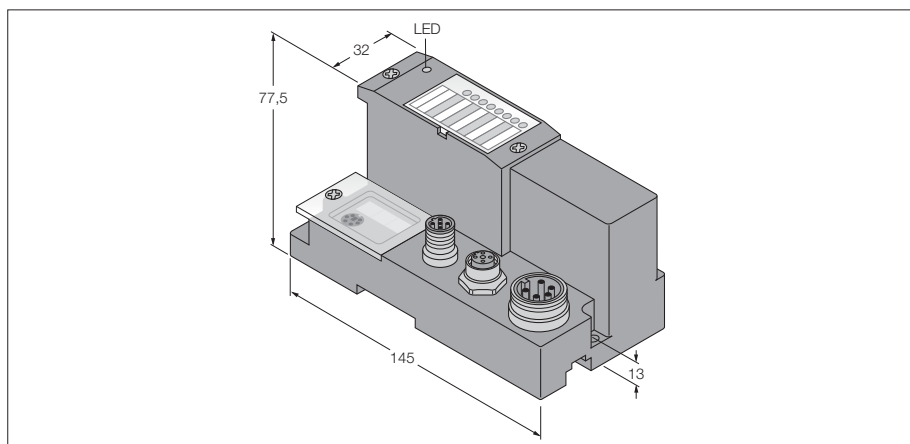

- 3 decimally coded rotary switches
- Degree of protection IP67
- LEDs for display of supply voltage, common alarm and bus errors
- Interface between the BL67 system and EtherNet/IP
- 10/100 Mbps
- One 4-pole M12 connector, D coding, for fieldbus connection
- One 5-pole 7/8" connector for power connection

<b>Type</b>	BL67-GW-EN-IP
Ident-No.	6827229
<b>Supply voltage</b>	24 VDC
Admissible range	18...30 VDC
Rated current from module bus	≤ 600 mA
Max. field supply current	10 A
Max. system supply current	1.5 A
Voltage supply connection	5-pole male 7/8" connector
<b>Fieldbus transmission rate</b>	10/100 Mbps
Fieldbus addressing	rotary switch, BOOTP, DHCP, IO-ASSISTANT
Service interface	RS232 interface (PS/2 socket)
Fieldbus connection technology	female M12 x 1 connector, 4-pole, D-coded
Voltage supply connection	5-pole male 7/8" connector
<b>Operating temperature</b>	-25...+70 °C
Function degrading operating temperature	
> 55 °C circulating air (ventilation)	no limitation
> 55 °C steady ambient air	I <sub>sens</sub> < 3A, I <sub>mb</sub> < 1A

**General technical data** see page 35

#### Accessories

<b>6914219</b>	RSSD-RSSD-441-6M/S2174	Ethernet cable M12 to M12 (4-pole, D-coded)
<b>6915781</b>	RSSD-RJ45-441-2M/S2174	Ethernet cable RJ45 to M12 (4-pole, D-coded)
<b>6914145</b>	RKM52-6M	power cable 7/8" unterminated end

#### Without function

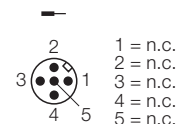

#### Ethernet

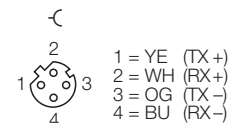

#### Voltage supply

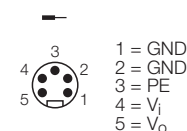

**Programmable gateway for the BL67 I/O system  
Interface for PROFIBUS-DP  
BL67-PG-DP**

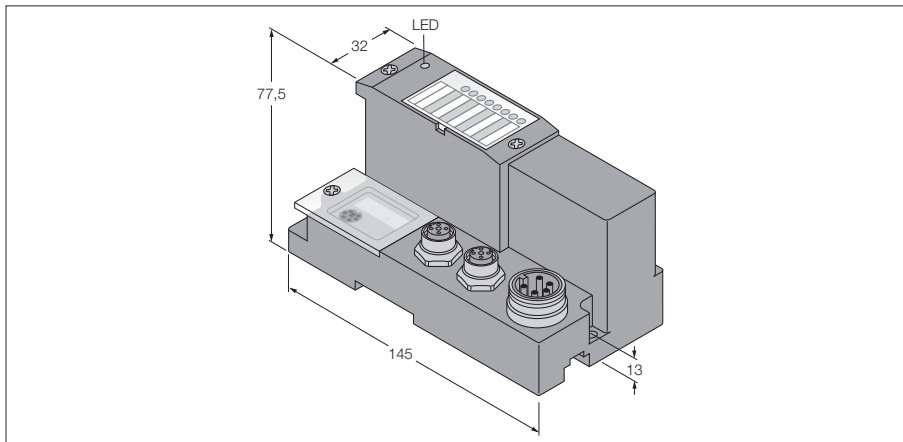

- Programmable acc.to IEC 61131-3 with CoDeSys
- Ethernet and RS232 programmable interface
- 512 kByte program memory
- 32 Bit RISC processor
- < 1 ms for 1000 instructions
- Degree of protection IP67
- LEDs for display of supply voltage, common alarm and bus errors
- Interface for PROFIBUS-DP (Slave)
- 12 Mbps

2

<b>Type</b>	BL67-PG-DP
Ident-No.	6827240
<b>Supply voltage</b>	24 VDC
Admissible range	18...30 VDC
Rated current from module bus	≤ 600 mA
Max. field supply current	10 A
Max. system supply current	1.5 A
Voltage supply connection	5-pole male 7/8" connector
<b>Fieldbus transmission rate</b>	9.6 kbps up to 12 Mbps
Fieldbus addressing range	1...125
Fieldbus addressing	Adjustment via CoDeSys software
Service interface	RS232 interface (PS/2 socket)
Fieldbus connection technology	female M12 x 1 connector, 5-pole, reverse-keyed
Voltage supply connection	5-pole male 7/8" connector
Fieldbus connection	external
<b>PLC data</b>	
Programming	CoDeSys V2.3
Released for CoDeSys version	V 2.3.6.4
Programming languages	IEC 61131-3 (IL, LD, FBD, SFC, ST)
Application tasks	1
Number of POUs	1024
Programming interface	RS232 interface, Ethernet
Processor	RISC, 32 bit
Cycle time	< 1 ms for 1000 IL commands (without I/O cycle)
Program memory	512 kByte
Data memory	512 kByte
Input data	4 kByte
Output data	4 kByte
Non-volatile memory	16 kByte
<b>Operating temperature</b>	-25...+70 °C
Function degrading operating temperature	
> 55 °C circulating air (ventilation)	no limitation
> 55 °C steady ambient air	Isens < 3A, I <sub>mb</sub> < 1A
<b>General technical data</b>	see page 35

**Profibus DP**

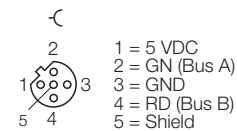

**Ethernet**

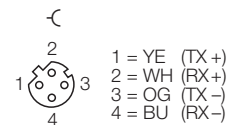

**Voltage supply**

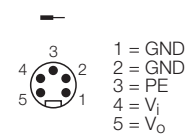

**Accessories**

<b>6915781</b>	RSSD-RJ45-441-2M/S2174	Ethernet cable RJ45 to M12 (4-pole, D-coded)
<b>6915769</b>	RKSW-D9T451-2M	Profibus cable M12 to sub-D
<b>6996009</b>	VB2-FSW-FKW-FSW-45	Profibus Y junction M12
<b>6601590</b>	RSS4.5-PDP-TR	Profibus M12 terminating resistor
<b>6914145</b>	RKM52-6M	power cable 7/8" unterminated end

# Programmable gateway for the BL67 I/O system

## Interface for MODBUS TCP

### BL67-PG-EN

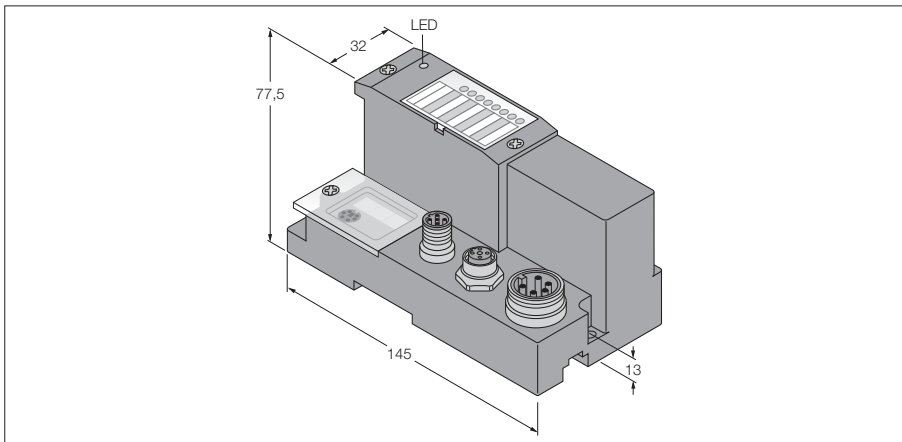

- Programmable acc.to IEC 61131-3 with CoDeSys
- Ethernet and RS232 programmable interface
- 512 kByte program memory
- 32 Bit RISC processor
- < 1 ms for 1000 instructions
- Degree of protection IP67
- LEDs for display of supply voltage, common alarm and bus errors
- Interface for MODBUS TCP
- 10/100 Mbps

<b>Type</b>	BL67-PG-EN
Ident-No.	6827241
<b>Supply voltage</b>	24 VDC
Admissible range	18...30 VDC
Rated current from module bus	≤ 600 mA
Max. field supply current	10 A
Max. system supply current	1.5 A
Voltage supply connection	5-pole male 7/8" connector
<b>Fieldbus transmission rate</b>	10/100 Mbps
Fieldbus addressing	rotary switch, BOOTP, DHCP, IO-ASSISTANT
Service interface	RS232 interface (PS/2 socket)
Fieldbus connection technology	female M12 x 1 connector, 4-pole, D-coded
Voltage supply connection	5-pole male 7/8" connector
<b>PLC data</b>	
Programming	CoDeSys V2.3
Released for CoDeSys version	V 2.3.6.4
Programming languages	IEC 61131-3 (IL, LD, FBD, SFC, ST)
Application tasks	1
Number of POUs	1024
Programming interface	RS232 interface, Ethernet
Processor	RISC, 32 bit
Cycle time	< 1 ms for 1000 IL commands (without I/O cycle)
Program memory	512 kByte
Data memory	512 kByte
Input data	4 kByte
Output data	4 kByte
Non-volatile memory	16 kByte
<b>Operating temperature</b>	-25...+70 °C
Function degrading operating temperature	
> 55 °C circulating air (ventilation)	no limitation
> 55 °C steady ambient air	Isens < 3A, I <sub>mb</sub> < 1A
<b>General technical data</b>	see page 35

#### Without function

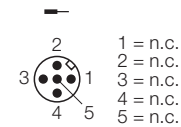

#### Ethernet

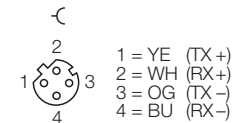

#### Voltage supply

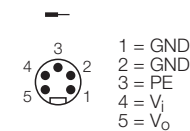

#### Accessories

<b>6914219</b>	RSSD-RSSD-441-6M/S2174	Ethernet cable M12 to M12 (4-pole, D-coded)
<b>6915781</b>	RSSD-RJ45-441-2M/S2174	Ethernet cable RJ45 to M12 (4-pole, D-coded)
<b>6914145</b>	RKM52-6M	power cable 7/8" unterminated end

**Programmable gateway for the BL67 I/O system  
Interface for EtherNet/IP  
BL67-PG-EN-IP**

2

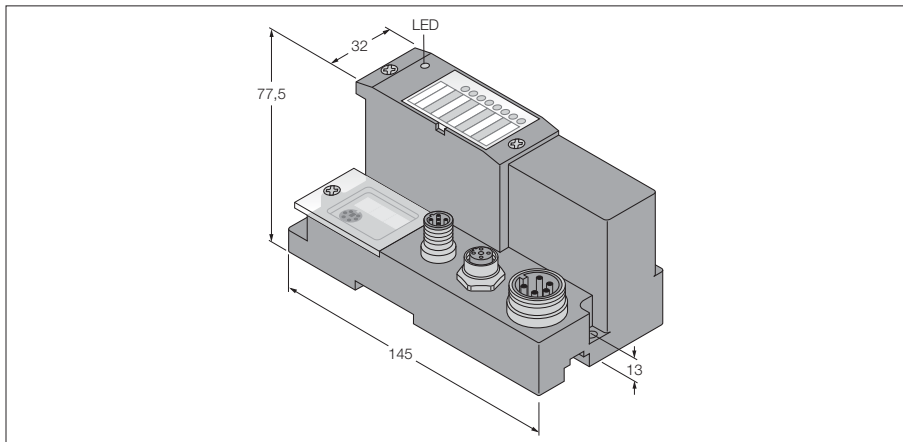

- Programmable acc.to IEC 61131-3 with CoDeSys
- Ethernet and RS232 programmable interface
- 512 kByte program memory
- 32 Bit RISC processor
- < 1 ms for 1000 instructions
- Degree of protection IP67
- LEDs for display of supply voltage, common alarm and bus errors
- Interface for EtherNet/IP
- 10/100 Mbps

<b>Type</b>	BL67-PG-EN-IP
Ident-No.	6827246
<b>Supply voltage</b>	24 VDC
Admissible range	18...30 VDC
Rated current from module bus	≤ 600 mA
Max. field supply current	10 A
Max. system supply current	1.5 A
Voltage supply connection	5-pole male 7/8" connector
<b>Fieldbus transmission rate</b>	10/100 Mbps
Fieldbus addressing	rotary switch, BOOTP, DHCP, IO-ASSISTANT
Service interface	RS232 interface (PS/2 socket)
Fieldbus connection technology	female M12 x 1 connector, 4-pole, D-coded
Voltage supply connection	5-pole male 7/8" connector
<b>PLC data</b>	
Programming	CoDeSys V2.3
Released for CoDeSys version	V 2.3.6.4
Programming languages	IEC 61131-3 (IL, LD, FBD, SFC, ST)
Application tasks	1
Number of POUs	1024
Programming interface	RS232 interface, Ethernet
Processor	RISC, 32 bit
Cycle time	< 1 ms for 1000 IL commands (without I/O cycle)
Program memory	512 kByte
Data memory	512 kByte
Input data	4 kByte
Output data	4 kByte
Non-volatile memory	16 kByte
<b>Operating temperature</b>	-25...+70 °C
Function degrading operating temperature	
> 55 °C circulating air (ventilation)	no limitation
> 55 °C steady ambient air	Isens < 3A, I <sub>mb</sub> < 1A
<b>General technical data</b>	see page 35

**Without function**

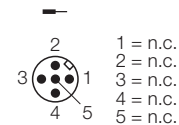

**Ethernet**

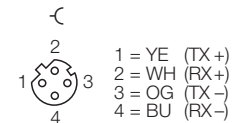

**Voltage supply**

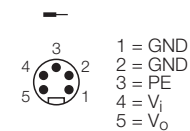

**Accessories**

- 6914219** RSSD-RSSD-441-6M/S2174 Ethernet cable M12 to M12 (4-pole, D-coded)
- 6915781** RSSD-RJ45-441-2M/S2174 Ethernet cable RJ45 to M12 (4-pole, D-coded)
- 6914145** RKM52-6M power cable 7/8" unterminated end

**BL67 electronic modules**  
**Power feeding module with diagnostics**  
**BL67-PF-24VDC**

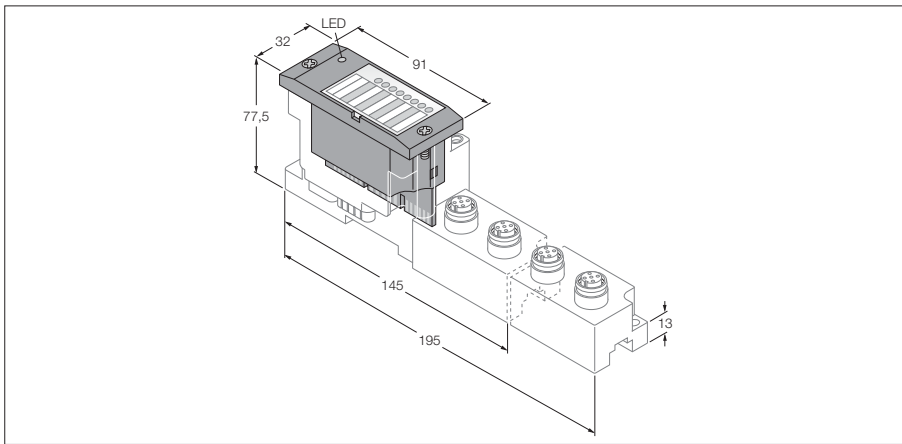

- Independent of the type of field-bus and connection technology used
- Degree of protection IP67
- LEDs for display of system status, field supply and diagnostic information
- Can be used to form potential groups
- Field supply featuring a rated voltage of 24 VDC

<b>Type</b>	BL67-PF-24VDC
Ident-No.	6827182
<b>Nominal voltage <math>V_i</math></b>	24 VDC
Nominal voltage $V_o$	24 VDC
Max. system supply $I_{mb}$	1.5 A
Max. sensor supply $I_{sens}$	4.0 A
Max. load current $I_o$	10 A
Admissible range	18...30 VDC
Rated current from module bus	$\leq 30$ mA
<b>Number of diagnostic bits</b>	3
<b>Operating temperature</b>	-25...+70 °C
<b>General technical data</b>	see page 35



**BL67 electronic modules**  
**Power feeding module with diagnostics**  
**BL67-PF-24VDC**

**Compatible base modules**

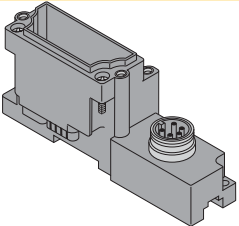
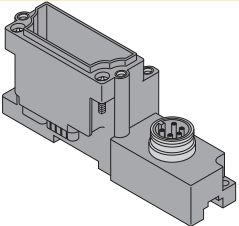
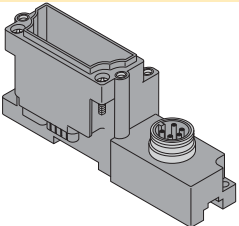
Dimensions	Type	Connection
	<b>6827190 BL67-B-1RSM</b> 1 x 7/8", 5-pole, male  Matching connection cable (for example): RKM52-6M Ident no. 6914145	F131, F134
	<b>6827201 BL67-B-1RSM-4</b> 1 x 7/8", 4-pole, male	F132, F135
	<b>6827236 BL67-B-1RSM-VO</b> 1 x 7/8", 5-pole, male  Matching connection cable (for example): RKM52-6M Ident no. 6914145	F133, F136

2

**Connection**

F131 - Pin configuration

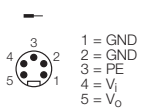

F133 - Pin configuration

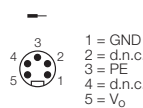

F135 - Module wiring diagram

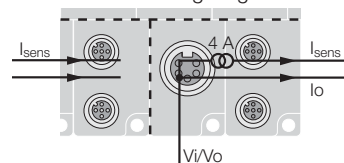

F132 - Pin configuration

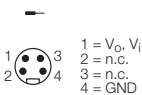

F134 - Module wiring diagram

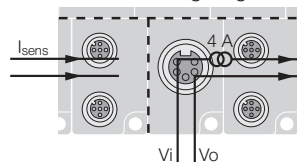

F136 - Module wiring diagram

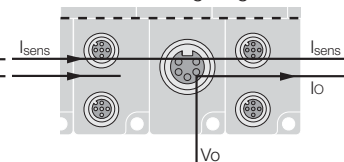

**BL67 electronic modules**  
**4 digital inputs**  
**BL67-4DI-P**

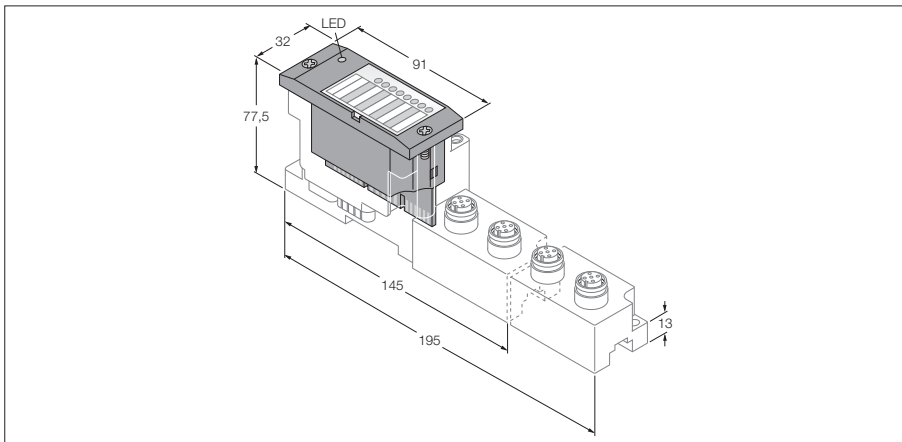

- Independent of the type of field-bus and connection technology used
- Degree of protection IP67
- LEDs for display of status and diagnostics
- Electronics galvanically isolated from the field level via opto-couplers
- 4 digital inputs, 24 VDC
- pnp

<b>Type</b>	BL67-4DI-P
Ident-No.	6827171
<b>Number of channels</b>	4
Nominal voltage $V_i$	24 VDC
Rated current from field supply	$\leq 40$ mA
Rated current from module bus	$\leq 30$ mA
Power loss, typical	$\leq 0.25$ W
<b>Input type</b>	pnp
Type of input diagnostics	group diagnostics
Low level signal voltage	$< 4.5$ V
High level signal voltage	7...30 V
Low level signal current	$< 1.5$ mA
High level signal current	2.1...3.7 mA
Input delay	0.25 ms
Electrical isolation	electronics for the field level
<b>Operating temperature</b>	-25...+70 °C
Function degrading operating temperature	
$< 0$ °C ambient temperature	switching on threshold drop, $1\text{mA} < I_e < 2.5\text{mA}$
<b>General technical data</b>	see page 35

**BL67 electronic modules**  
**4 digital inputs**  
**BL67-4DI-P**

**Compatible base modules**

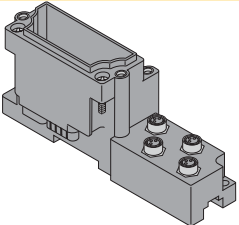
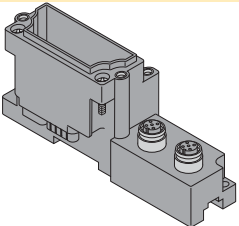
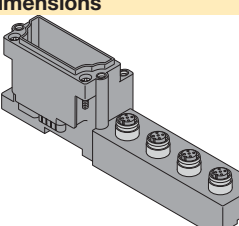
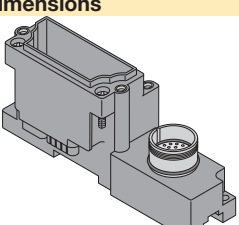
Dimensions	Type	Connection
	<b>6827189 BL67-B-4M8</b> 4 x M8, 3-pole, female  Matching connection cable (for example): SKP32-SSP3/S90 Ident-No. 8008685	F137, F141
	<b>6827186 BL67-B-2M12</b> 2 x M12, 5-pole, female, A-coded <b>6827194 BL67-B-2M12-P</b> 2 x M12, 5-pole, female, A-coded, paired  Matching connection cable (for example): WAK4-2-WAS4/S90 Ident-No. 8006739	F138, F142, F144
	<b>6827187 BL67-B-4M12</b> 4 x M12, 5-pole, female, A-coded  Matching connection cable (for example): WAK4-2-WAS4/S90 Ident-No. 8006739	F139, F143
	<b>6827213 BL67-B-1M23</b> 1 x M23, 12-pole, female  Field-wireable connector (for example): FW-M23ST12Q-G-LT-ME-XX-10 Ident-No. 6604070	F140

2

**Connection**

F137 - Pin configuration

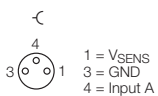

F139 - Pin configuration

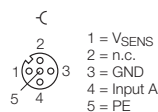

F141 - Wiring diagram

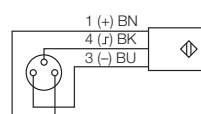

F143 - Wiring diagram



F138 - Pin configuration

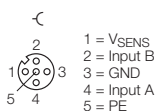

F140 - Pin configuration

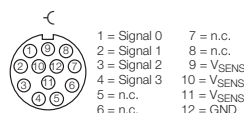

F142 - Wiring diagram

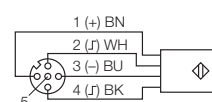

F144 - Wiring diagram

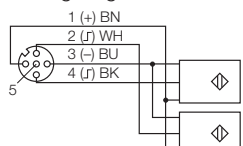

**BL67 electronic modules**  
**8 digital inputs**  
**BL67-8DI-P**

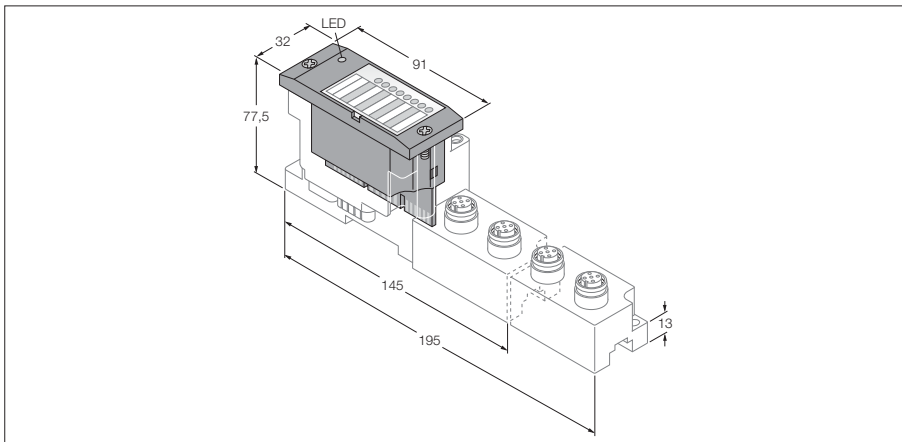

- Independent of the type of field-bus and connection technology used
- Degree of protection IP67
- LEDs for display of status and diagnostics
- Electronics galvanically isolated from the field level via opto-couplers
- 8 digital inputs, 24 VDC
- pnp

<b>Type</b>	BL67-8DI-P
Ident-No.	6827170
<b>Number of channels</b>	8
Nominal voltage $V_i$	24 VDC
Rated current from field supply	$\leq 40$ mA
Rated current from module bus	$\leq 30$ mA
Power loss, typical	$\leq 0.25$ W
<b>Input type</b>	pnp
Type of input diagnostics	group diagnostics
Low level signal voltage	$< 4.5$ V
High level signal voltage	7...30 V
Low level signal current	$< 1.5$ mA
High level signal current	2.1...3.7 mA
Input delay	0.25 ms
Electrical isolation	electronics for the field level
<b>Operating temperature</b>	-25...+70 °C
Function degrading operating temperature	
< 0 °C ambient temperature	switching on threshold drop, $1\text{mA} < I_e < 2.5\text{mA}$
> 55 °C circulating air (Ventilation)	no limitation
> 55 °C steady ambient air	simultaneity factor 0.5
<b>General technical data</b>	see page 35

**BL67 electronic modules**  
**8 digital inputs**  
**BL67-8DI-P**

**Compatible base modules**

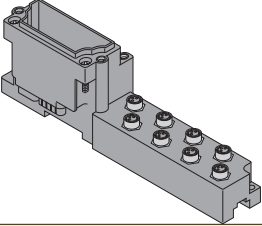
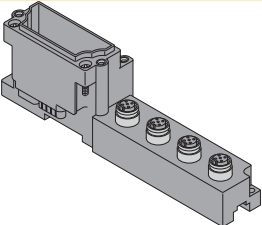
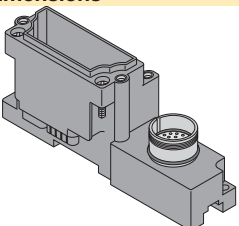
Dimensions	Type	Connection
	<b>6827188 BL67-B-8M8</b> 8 x M8, 3-pole, female  Matching connection cable (for example): SKP32-SSP3/S90 Ident-No. 8008685	F137, F141
	<b>6827187 BL67-B-4M12</b> 4 x M12, 5-pole, female  <b>6827195 BL67-B-4M12-P</b> 4 x M12, 5-pole, female, paired  Matching connection cable (for example): WAK4-2-WAS4/S90 Ident-No. 8006739  Y-piece for single assignment: FSM5-2FKM5.4/S55/S1874 Ident-No. 8021378	F138, F142, F144
	<b>6827213 BL67-B-1M23</b> 1 x M23, 12-pole, female  Field-wireable connector (for example): FW-M23ST12Q-G-LT-ME-XX-10 Ident-No. 6604070	F145

2

**Connection**

F137 - Pin configuration

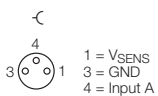

F145 - Pin configuration

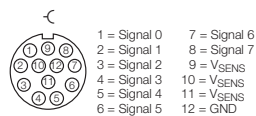

F142 - Wiring diagram

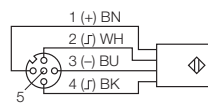

F138 - Pin configuration

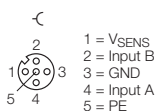

F141 - Wiring diagram

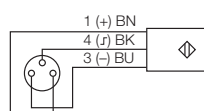

F144 - Wiring diagram

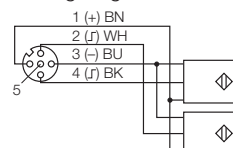

**BL67 electronic modules**  
**4 digital inputs**  
**BL67-4DI-PD**

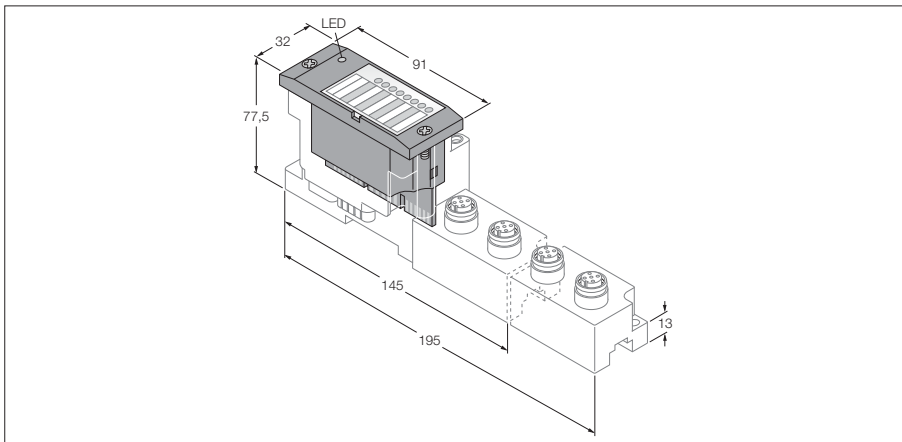

- Independent of the type of field-bus and connection technology used
- Degree of protection IP67
- LEDs for display of status and diagnostics
- Electronics galvanically isolated from the field level via opto-couplers
- 4 digital inputs, 24 VDC
- pnp
- Channel diagnostics
- Wire-break monitoring
- Selection of filter times
- Input inverting possible

<b>Type</b>	BL67-4DI-PD
Ident-No.	6827204
<b>Number of channels</b>	4
Nominal voltage $V_i$	24 VDC
Rated current from field supply	$\leq 100$ mA
Rated current from module bus	$\leq 30$ mA
Power loss, typical	$\leq 1.5$ W
<b>Input type</b>	pnp
Type of input diagnostics	channel diagnostics
Low level signal voltage	$< 4.5$ V
High level signal voltage	7...30 V
Low level signal current	$< 1.5$ mA
High level signal current	2.1...3.7 mA
Input delay	0.25; 2.5 ms
Electrical isolation	electronics for the field level
<b>Number of diagnostic bits</b>	6
Number of parameter bytes	4
<b>Operating temperature</b>	-25...+70 °C
Function degrading operating temperature	
$< 0$ °C ambient temperature	support for version VN 01-03 and higher, no limitation
<b>General technical data</b>	see page 35

**BL67 electronic modules**  
**4 digital inputs**  
**BL67-4DI-PD**

**Compatible base modules**

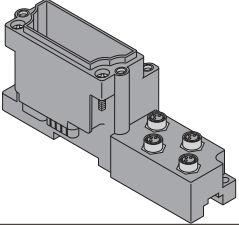
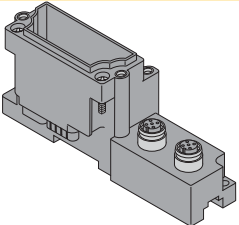
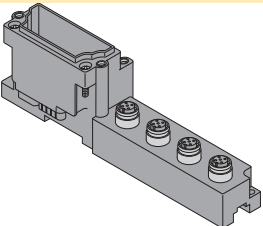
Dimensions	Type	Connection
	<b>6827189 BL67-B-4M8</b> 4 x M8, 3-pole, female  Matching connection cable (for example): SKP32-SSP3/S90 Ident-No. 8008685	F137, F141
	<b>6827186 BL67-B-2M12</b> 2 x M12, 5-pole, female, A-coded  <b>6827194 BL67-B-2M12-P</b> 2 x M12, 5-pole, female, A-coded, paired  If the wire-break monitoring has been activated, on the sensor side a jumper between pin 1 (24 V DC) and pin 2 (diagnostics input) must be implemented for monitoring of wire-breaks.  Note: Wire-break monitoring only in connection with the base module BL67-B-2M12 possible!	F138, F142, F144, F146
	<b>6827187 BL67-B-4M12</b> 4 x M12, 5-pole, female, A-coded  Matching connection cable (for example): WAK4-2-WAS4/S90 Ident-No. 8006739	F139, F143

2

**Connection**

F137 - Pin configuration

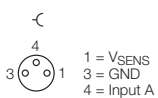

F139 - Pin configuration

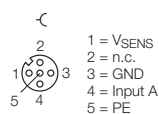

F142 - Wiring diagram

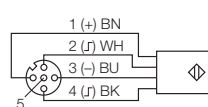

F144 - Wiring diagram

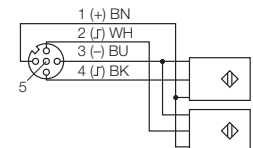

F138 - Pin configuration

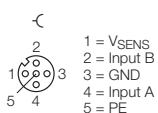

F141 - Wiring diagram

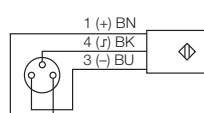

F143 - Wiring diagram

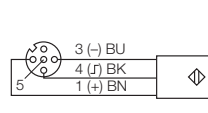

F146 - Wire-break monitoring wiring diagram

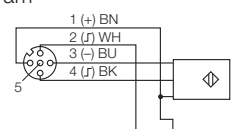

**BL67 electronic modules**  
**8 digital inputs**  
**BL67-8DI-PD**

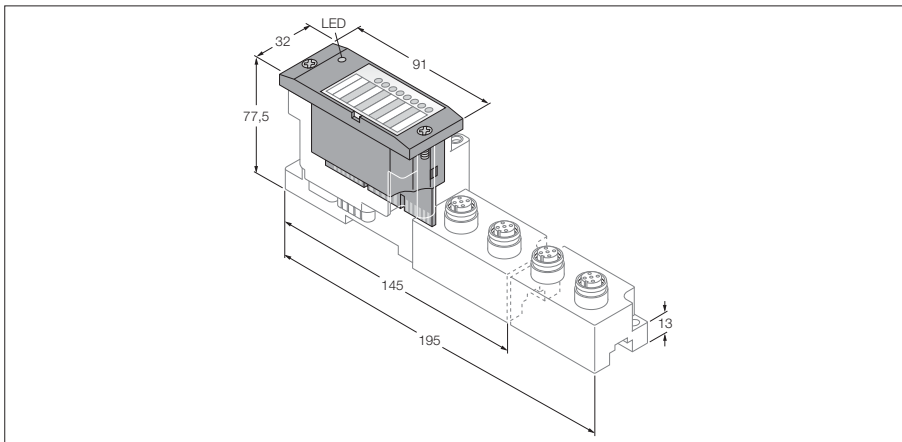

- Independent of the type of field-bus and connection technology used
- Degree of protection IP67
- LEDs for display of status and diagnostics
- Electronics galvanically isolated from the field level via opto-couplers
- 8 digital inputs, 24 VDC
- pnp
- Channel diagnostics
- Wire-break monitoring
- Selection of filter times
- Input inverting possible

<b>Type</b>	BL67-8DI-PD
Ident-No.	6827205
<b>Number of channels</b>	8
Nominal voltage $V_i$	24 VDC
Rated current from field supply	$\leq 100$ mA
Rated current from module bus	$\leq 30$ mA
Power loss, typical	$\leq 1.5$ W
<b>Input type</b>	pnp
Type of input diagnostics	channel diagnostics
Low level signal voltage	$< 4.5$ V
High level signal voltage	7...30 V
Low level signal current	$< 1.5$ mA
High level signal current	2.1...3.7 mA
Input delay	0.25; 2.5 ms
Electrical isolation	electronics for the field level
<b>Number of diagnostic bits</b>	12
Number of parameter bytes	8
<b>Operating temperature</b>	-25...+70 °C
Function degrading operating temperature	
< 0 °C ambient temperature	Support for version VN 01-03 and higher, no limitation
> 55 °C circulating air (ventilation)	no limitation
> 55 °C steady ambient air	simultaneity factor 0.5
<b>General technical data</b>	see page 35



**BL67 electronic modules**  
**8 digital inputs**  
**BL67-8DI-PD**

**Compatible base modules**

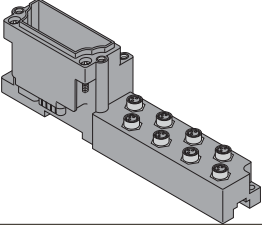
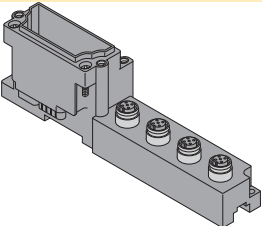
Dimensions	Type	Connection
	<p><b>6827188 BL67-B-8M8</b> 8 x M8, 3-pole, female</p> <p>Matching connection cable (for example): SKP32-SSP3/S90 Ident-No. 8008685</p>	F137, F141
	<p><b>6827187 BL67-B-4M12</b> 4 x M12, 5-pole, female</p> <p><b>6827195 BL67-B-4M12-P</b> 4 x M12, 5-pole, female, paired</p> <p>If the wire-break monitoring has been activated, on the sensor side a jumper between pin 1 (24 V DC) and pin 2 (diagnostics input) must be implemented for monitoring of wire-breaks.</p> <p>Note: Wire-break monitoring only in connection with possible with the base module BL67-B-4M12!</p>	F138, F142, F144, F146

2

**Connection**

F137 - Pin configuration

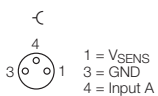

F141 - Wiring diagram

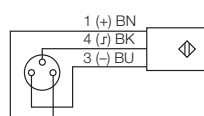

F144 - Wiring diagram

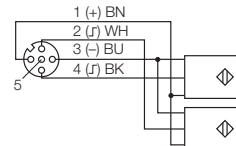

F138 - Pin configuration

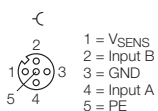

F142 - Wiring diagram

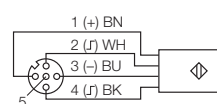

F146 - Wire-break monitoring wiring diagram

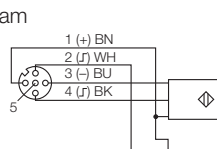

**BL67 electronic modules**  
**4 digital inputs**  
**BL67-4DI-N**

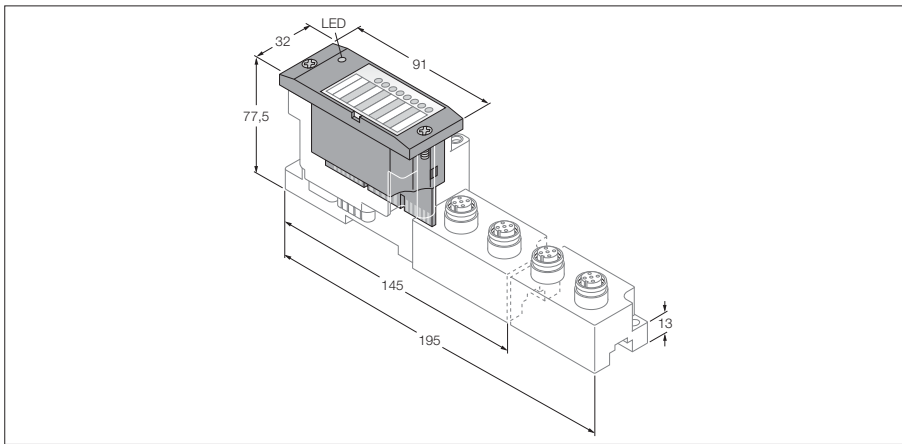

- Independent of the type of field-bus and connection technology used
- Degree of protection IP67
- LEDs for display of status and diagnostics
- Electronics galvanically isolated from the field level via opto-couplers
- 4 digital inputs, 24 VDC
- npn

<b>Type</b>	BL67-4DI-N
Ident-No.	6827206
<b>Number of channels</b>	4
Nominal voltage $V_i$	24 VDC
Rated current from field supply	$\leq 1$ mA
Rated current from module bus	$\leq 30$ mA
Power loss, typical	$\leq 1.3$ W
<b>Input type</b>	npn
Type of input diagnostics	group diagnostics
Low level signal voltage	$> 7$ V
High level signal voltage	$< 5$ V
Low level signal current	$< 2.5$ mA
High level signal current	$> 3$ mA
Input delay	0.25 ms
Electrical isolation	electronics for the field level
<b>Operating temperature</b>	$-25 \dots +70$ °C
<b>General technical data</b>	see page 35

**BL67 electronic modules**  
**4 digital inputs**  
**BL67-4DI-N**

**Compatible base modules**

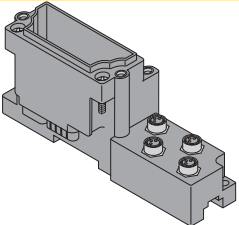
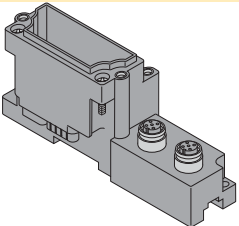
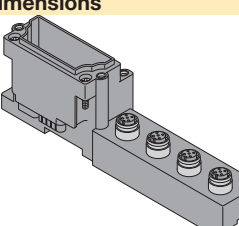
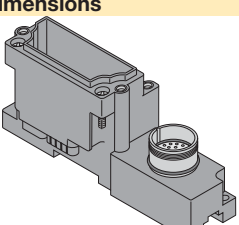
Dimensions	Type	Connection
	<b>6827189 BL67-B-4M8</b> 4 x M8, 3-pole, female  Matching connection cable (for example): SKP32-SSP3/S90 Ident-No. 8008685	F137, F141
	<b>6827186 BL67-B-2M12</b> 2 x M12, 5-pole, female, A-coded  <b>6827194 BL67-B-2M12-P</b> 2 x M12, 5-pole, female, A-coded, paired  Matching connection cable (for example): WAK4-2-WAS4/S90 Ident-No. 8006739	F138, F142, F144
	<b>6827187 BL67-B-4M12</b> 4 x M12, 5-pole, female, A-coded  Matching connection cable (for example): WAK4-2-WAS4/S90 Ident-No. 8006739	F139, F143
	<b>6827213 BL67-B-1M23</b> 1 x M23, 12-pole, female  Field-wireable connector (for example): FW-M23ST12Q-G-LT-ME-XX-10 Ident-No. 6604070	F140

2

**Connection**

F137 - Pin configuration

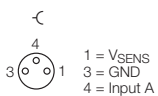

F139 - Pin configuration

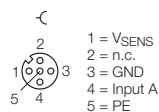

F141 - Wiring diagram

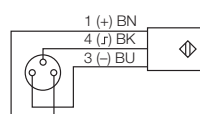

F143 - Wiring diagram



F138 - Pin configuration

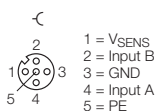

F140 - Pin configuration

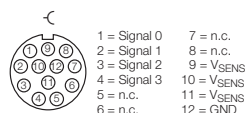

F142 - Wiring diagram

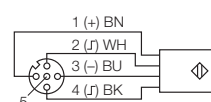

F144 - Wiring diagram

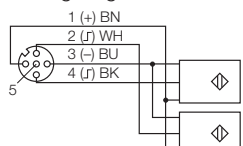

**BL67 electronic modules**  
**8 digital inputs**  
**BL67-8DI-N**

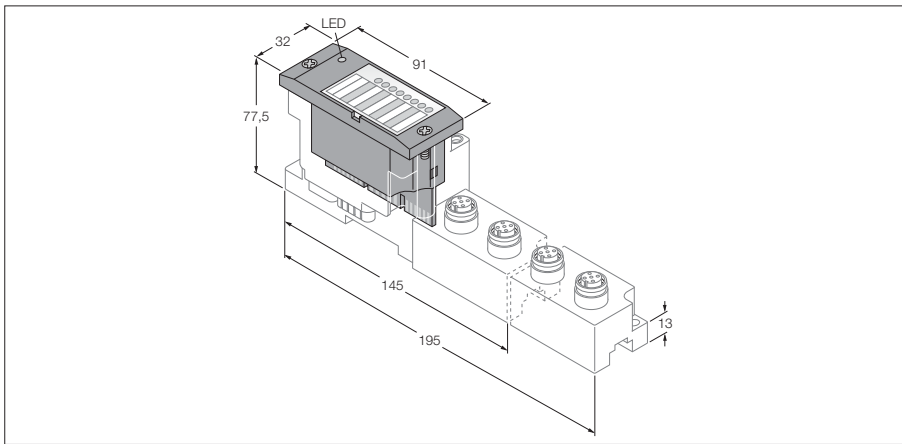

- Independent of the type of field-bus and connection technology used
- Degree of protection IP67
- LEDs for display of status and diagnostics
- Electronics galvanically isolated from the field level via opto-couplers
- 8 digital inputs, 24 VDC
- npn

<b>Type</b>	BL67-8DI-N
Ident-No.	6827207
<b>Number of channels</b>	8
Nominal voltage $V_i$	24 VDC
Rated current from field supply	$\leq 1 \text{ mA}$
Rated current from module bus	$\leq 30 \text{ mA}$
Power loss, typical	$\leq 1.3 \text{ W}$
<b>Input type</b>	npn
Type of input diagnostics	group diagnostics
Low level signal voltage	$> 7 \text{ V}$
High level signal voltage	$< 5 \text{ V}$
Low level signal current	$< 1.2 \text{ mA}$
High level signal current	$> 1.5 \text{ mA}$
Input delay	0.25 ms
Electrical isolation	electronics for the field level
<b>Operating temperature</b>	$-25 \dots +70 \text{ }^\circ\text{C}$
Function degrading operating temperature	
$> 55 \text{ }^\circ\text{C}$ circulating air (Ventilation)	no limitation
$> 55 \text{ }^\circ\text{C}$ steady ambient air	simultaneity factor 0.5
<b>General technical data</b>	see page 35

**BL67 electronic modules**  
**8 digital inputs**  
**BL67-8DI-N**

**Compatible base modules**

Dimensions	Type	Connection
	<b>6827188 BL67-B-8M8</b> 8 x M8, 3-pole, female  Matching connection cable (for example): SKP32-SSP3/S90 Ident-No. 8008685	F137, F141
	<b>6827187 BL67-B-4M12</b> 4 x M12, 5-pole, female  <b>6827195 BL67-B-4M12-P</b> 4 x M12, 5-pole, female, paired  Matching connection cable (for example): WAK4-2-WAS4/S90 Ident-No. 8006739	F138, F142, F144
	<b>6827213 BL67-B-1M23</b> 1 x M23, 12-pole, female  Field-wireable connector (for example): FW-M23ST12Q-G-LT-ME-XX-10 Ident-No. 6604070	F145

2

**Connection**

F137 - Pin configuration

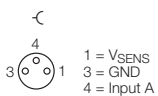

F145 - Pin configuration

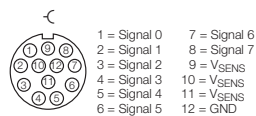

F142 - Wiring diagram

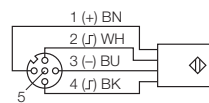

F138 - Pin configuration

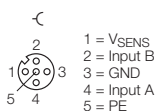

F141 - Wiring diagram

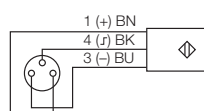

F144 - Wiring diagram

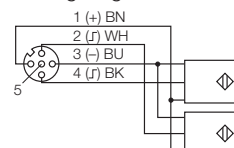

**BL67 electronic modules**  
**4 digital outputs**  
**BL67-4DO-0.5A-P**

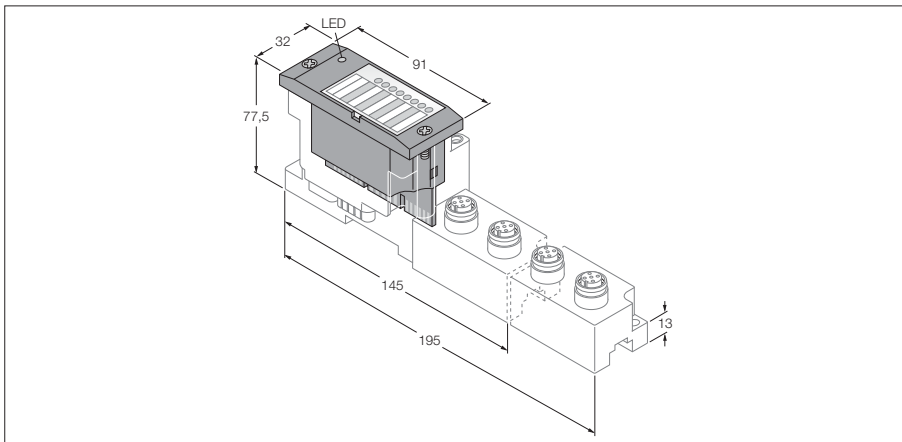

- Independent of the type of field-bus and connection technology used
- Degree of protection IP67
- LEDs for display of status and diagnostics
- Electronics galvanically isolated from the field level via opto-couplers
- 4 digital outputs, 24 VDC
- 0.5 A max.
- pnp

<b>Type</b>	BL67-4DO-0.5A-P
Ident-No.	6827173
<b>Number of channels</b>	4
Nominal voltage $V_o$	24 VDC
Rated current from field supply	$\leq 100$ mA
Rated current from module bus	$\leq 30$ mA
Power loss, typical	$\leq 1.5$ W
<b>Output type</b>	pnp
Output voltage	24 VDC
Output current per channel	0.5 A
Output delay	3 ms
Load type	resistive, inductive, lamp load
Load resistance, resistive	$> 48 \Omega$
Load resistance, inductive	$< 1.2$ H
Lamp load	$< 3$ W
Switching frequency, resistive	$< 200$ Hz
Inductive switching frequency	$< 2$ Hz
Switching frequency, lamp load	$< 20$ Hz
Short-circuit protection	yes
Simultaneity factor	1
Electrical isolation	electronics for the field level
<b>Number of diagnostic bits</b>	4
<b>Operating temperature</b>	$-25 \dots +70$ °C
Function degrading operating temperature	
$< 0$ °C ambient temperature	support for version VN 01-03 and higher, no limitation
<b>General technical data</b>	see page 35

**BL67 electronic modules**  
**4 digital outputs**  
**BL67-4DO-0.5A-P**

**Compatible base modules**

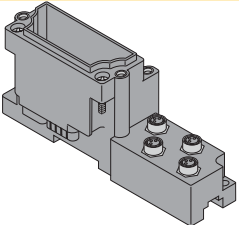
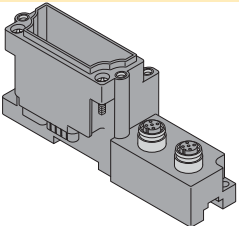
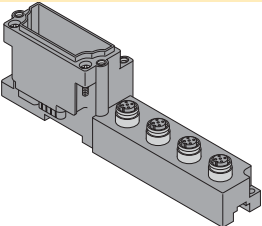
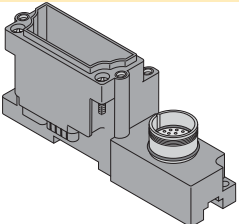
Dimensions	Type	Connection
	<b>6827189 BL67-B-4M8</b> 4 x M8, 3-pole, female  Matching connection cable (for example): SKP32-SSP3/S90 Ident-No. 8008685	F147, F150
	<b>6827186 BL67-B-2M12</b> 2 x M12, 5-pole, female, A-coded  <b>6827194 BL67-B-2M12-P</b> 2 x M12, 5-pole, female, A-coded, paired  Matching connection cable (for example): WAK4-2-WAS4/S90 Ident-No. 8006739	F148, F151
	<b>6827187 BL67-B-4M12</b> 4 x M12, 5-pole, female, A-coded  Matching connection cable (for example): WAK4-2-WAS4/S90 Ident-No. 8006739	F149, F152
	<b>6827213 BL67-B-1M23</b> 1 x M23, 12-pole, female  Field-wireable connector (for example): FW-M23ST12Q-G-LT-ME-XX-10 Ident-No. 6604070	F140

2

**Connection**

F147 - Pin configuration

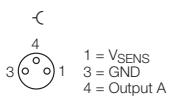

F149 - Pin configuration

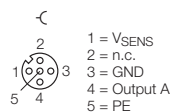

F150 - Wiring diagram

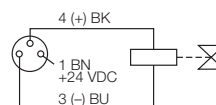

F152 - Wiring diagram

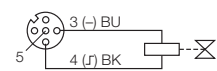

F148 - Pin configuration

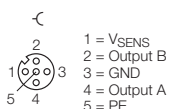

F140 - Pin configuration

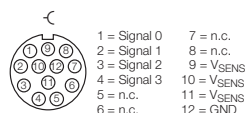

F151 - Wiring diagram

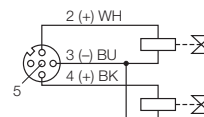

**BL67 electronic modules**  
**4 digital outputs**  
**BL67-4DO-2A-P**

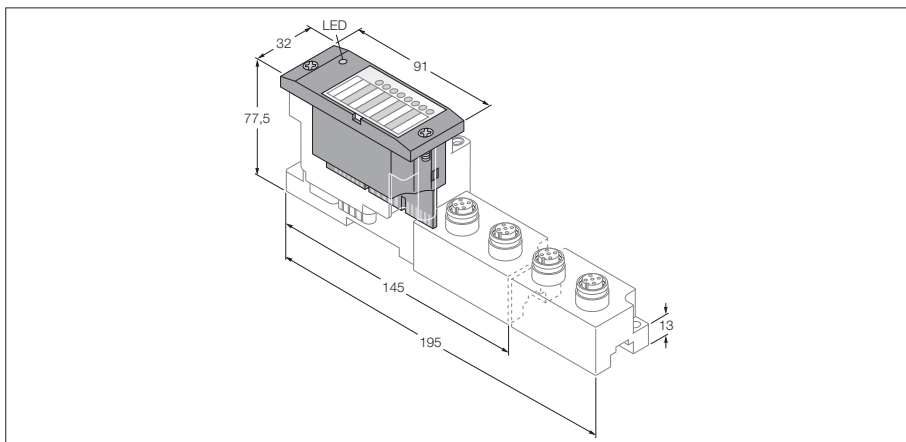

- Independent of the type of field-bus and connection technology used
- Degree of protection IP67
- LEDs for display of status and diagnostics
- Electronics galvanically isolated from the field level via opto-couplers
- 4 digital outputs, 24 VDC
- 2 A max.
- pnp

<b>Type</b>	BL67-4DO-2A-P
Ident-No.	6827174
<b>Number of channels</b>	4
Nominal voltage $V_o$	24 VDC
Rated current from field supply	$\leq 100$ mA
Rated current from module bus	$\leq 30$ mA
Power loss, typical	$\leq 1.5$ W
<b>Output type</b>	pnp
Output voltage	24 VDC
Output current per channel	2.0 A
Output delay	3 ms
Load type	resistive, inductive, lamp load
Load resistance, resistive	$> 12 \Omega$
Load resistance, inductive	$< 1.2$ H
Lamp load	$< 10$ W
Switching frequency, resistive	$< 200$ Hz
Inductive switching frequency	$< 2$ Hz
Switching frequency, lamp load	$< 20$ Hz
Short-circuit protection	yes
Simultaneity factor	1
Electrical isolation	electronics for the field level
<b>Number of diagnostic bits</b>	4
<b>Operating temperature</b>	-25...+70 °C
Function degrading operating temperature	
< 0 °C ambient temperature	support for version VN 01-03 and higher, no limitation
> 55 °C circulating air (Ventilation)	no limitation
> 55 °C steady ambient air	simultaneity factor 0.5
<b>General technical data</b>	see page 35



**BL67 electronic modules**  
**4 digital outputs**  
**BL67-4DO-2A-P**

**Compatible base modules**

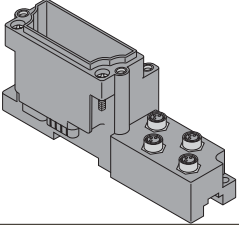
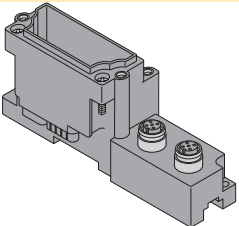
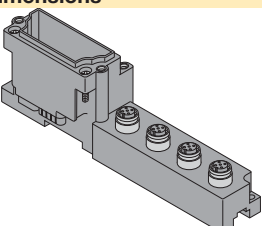
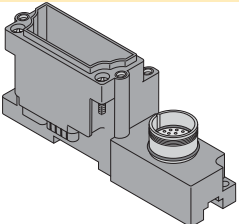
Dimensions	Type	Connection
	<b>6827189 BL67-B-4M8</b> 4 x M8, 3-pole, female  Matching connection cable (for example): SKP32-SSP3/S90 Ident-No. 8008685	F147, F150
	<b>6827186 BL67-B-2M12</b> 2 x M12, 5-pole, female, A-coded  <b>6827194 BL67-B-2M12-P</b> 2 x M12, 5-pole, female, A-coded, paired  Matching connection cable (for example): WAK4-2-WAS4/S90 Ident-No. 8006739	F148, F151
	<b>6827187 BL67-B-4M12</b> 4 x M12, 5-pole, female, A-coded  Matching connection cable (for example): WAK4-2-WAS4/S90 Ident-No. 8006739	F149, F152
	<b>6827213 BL67-B-1M23</b> 1 x M23, 12-pole, female  Field-wireable connector (for example): FW-M23ST12Q-G-LT-ME-XX-10 Ident-No. 6604070	F140

2

**Connection**

F147 - Pin configuration

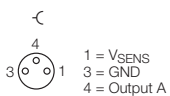

F149 - Pin configuration

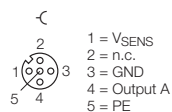

F150 - Wiring diagram

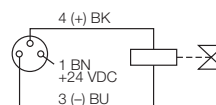

F152 - Wiring diagram

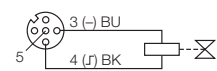

F148 - Pin configuration

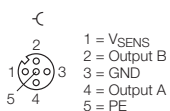

F140 - Pin configuration

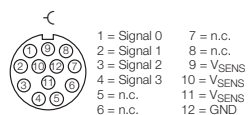

F151 - Wiring diagram

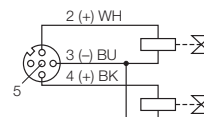

**BL67 electronic modules**  
**8 digital outputs**  
**BL67-8DO-0.5A-P**

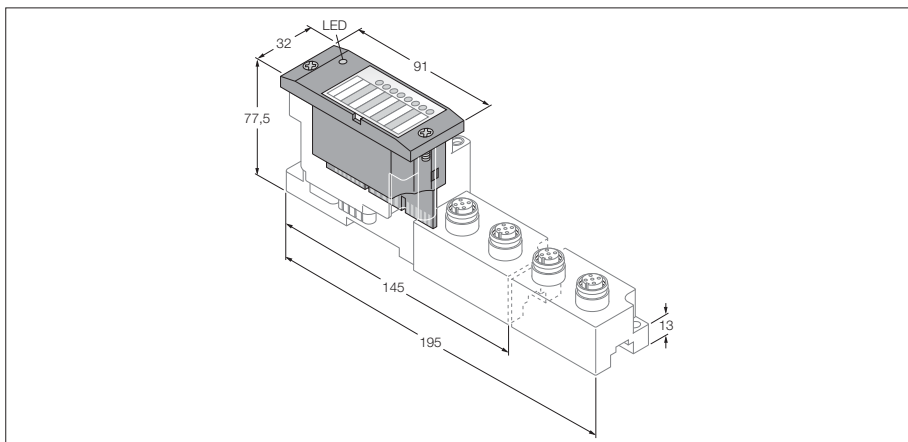

- Independent of the type of field-bus and connection technology used
- Degree of protection IP67
- LEDs for display of status and diagnostics
- Electronics galvanically isolated from the field level via opto-couplers
- 8 digital outputs, 24 VDC
- 0.5 A max.
- pnp

<b>Type</b>	BL67-8DO-0.5A-P
Ident-No.	6827172
<b>Number of channels</b>	8
Nominal voltage $V_o$	24 VDC
Rated current from field supply	$\leq 100$ mA
Rated current from module bus	$\leq 30$ mA
Power loss, typical	$\leq 1.5$ W
<b>Output type</b>	pnp
Output voltage	24 VDC
Output current per channel	0.5 A
Output delay	3 ms
Load type	resistive, inductive, lamp load
Load resistance, resistive	$> 48 \Omega$
Load resistance, inductive	$< 1.2$ H
Lamp load	$< 3$ W
Switching frequency, resistive	$< 200$ Hz
Inductive switching frequency	$< 2$ Hz
Switching frequency, lamp load	$< 20$ Hz
Short-circuit protection	yes
Simultaneity factor	1
Electrical isolation	electronics for the field level
<b>Number of diagnostic bits</b>	8
<b>Operating temperature</b>	-25...+70 °C
Function degrading operating temperature	
< 0 °C ambient temperature	support for version VN 01-03 and higher, no limitation
> 55 °C circulating air (ventilation)	no limitation
> 55 °C steady ambient air	simultaneity factor 0.5
<b>General technical data</b>	see page 35

**BL67 electronic modules**  
**8 digital outputs**  
**BL67-8DO-0.5A-P**

**Compatible base modules**

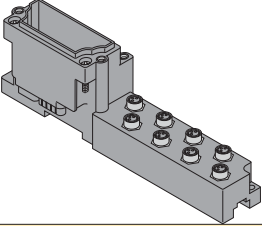
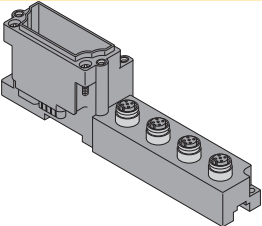
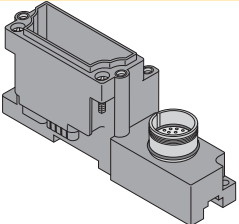
Dimensions	Type	Connection
	<b>6827188 BL67-B-8M8</b> 8 x M8, 3-pole, female  Matching connection cable (for example): SKP32-SSP3/S90 Ident-No. 8008685	F147, F150
	<b>6827187 BL67-B-4M12</b> 4 x M12, 5-pole, female  <b>6827195 BL67-B-4M12-P</b> 4 x M12, 5-pole, female, paired  Matching connection cable (for example): WAK4-2-WAS4/S90 Ident-No. 8006739	F148, F151
	<b>6827213 BL67-B-1M23</b> 1 x M23, 12-pole, female  Field-wireable connector (for example): FW-M23ST12Q-G-LT-ME-XX-10 Ident-No. 6604070	F145

2

**Connection**

F147 - Pin configuration

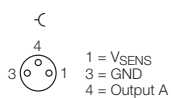

F145 - Pin configuration

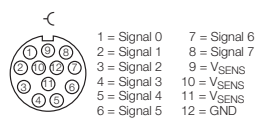

F151 - Wiring diagram

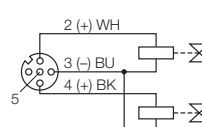

F148 - Pin configuration

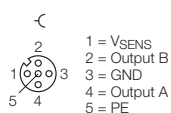

F150 - Wiring diagram

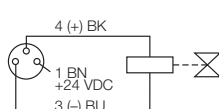

**BL67 electronic modules**  
**16 digital outputs**  
**BL67-16DO-0.1A-P**

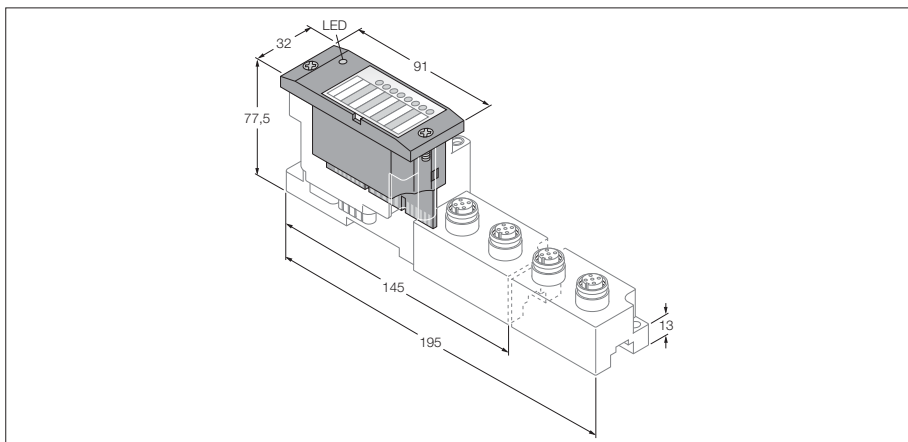

- Independent of the type of field-bus and connection technology used
- Degree of protection IP67
- LEDs for display of status and diagnostics
- Electronics galvanically isolated from the field level via opto-couplers
- 16 digital outputs, 24 VDC
- 0.1 A max.
- pnp
- Channel diagnostics

<b>Type</b>	BL67-16DO-0.1A-P
Ident-No.	6827221
<b>Number of channels</b>	16
Nominal voltage $V_o$	24 VDC
Rated current from field supply	$\leq 100$ mA
Rated current from module bus	$\leq 30$ mA
Power loss, typical	$\leq 1.5$ W
<b>Output type</b>	pnp
Output voltage	24 VDC
Output current per channel	0.1 A
Output delay	3 ms
Load type	resistive, inductive
Load resistance, resistive	$> 250 \Omega$
Load resistance, inductive	$< 1.2$ H
Switching frequency, resistive	$< 200$ Hz
Inductive switching frequency	$< 2$ Hz
Switching frequency, lamp load	$< 20$ Hz
Short-circuit protection	yes
Simultaneity factor	1
Electrical isolation	electronics for the field level
<b>Number of diagnostic bits</b>	16
Number of parameter bytes	2
<b>Operating temperature</b>	$-25 \dots +70$ °C
Function degrading operating temperature	
> 55 °C circulating air (ventilation)	no limitation
> 55 °C steady ambient air	simultaneity factor 0.5
<b>General technical data</b>	see page 35

**BL67 electronic modules**  
**16 digital outputs**  
**BL67-16DO-0.1A-P**

**Compatible base modules**

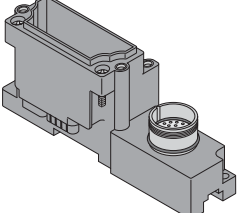
Dimensions	Type	Connection
	<p><b>6827216 BL67-B-1M23-19</b> 1 x M23, 19-pole, female</p> <p>Field-wireable connector (for example): FW-M23ST19Q-G-LT-ME-XX-10 Ident-No. 6604208</p>	<p>F153</p>

**2**

**Connection**

F153 - Pin configuration

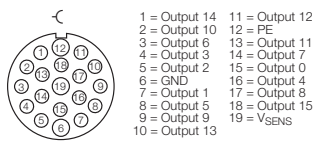

**BL67 electronic modules**  
**4 digital outputs**  
**BL67-4DO-2A-N**

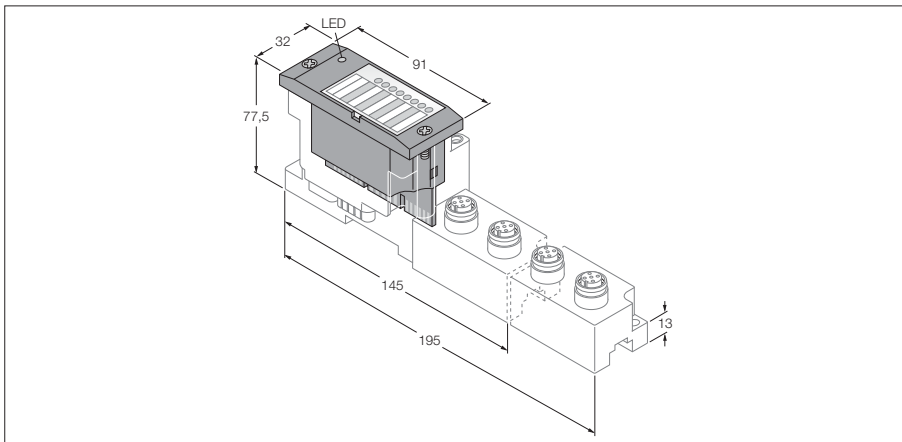

- Independent of the type of field-bus and connection technology used
- Degree of protection IP67
- LEDs for display of status and diagnostics
- Electronics galvanically isolated from the field level via opto-couplers
- 4 digital outputs, 24 VDC
- 2 A max.
- npn

<b>Type</b>	BL67-4DO-2A-N
Ident-No.	6827210
<b>Number of channels</b>	4
Nominal voltage $V_o$	24 VDC
Rated current from field supply	$\leq 100$ mA
Rated current from module bus	$\leq 30$ mA
Power loss, typical	$\leq 1.5$ W
<b>Output type</b>	npn
Output voltage	24 VDC
Output current per channel	2.0 A
Output delay	3 ms
Load type	resistive, inductive, lamp load
Load resistance, resistive	$> 12 \Omega$
Load resistance, inductive	$< 1.2$ H
Lamp load	$< 6$ W
Switching frequency, resistive	$< 200$ Hz
Inductive switching frequency	$< 2$ Hz
Switching frequency, lamp load	$< 20$ Hz
Short-circuit protection	yes
Simultaneity factor	1
Electrical isolation	electronics for the field level
<b>Number of diagnostic bits</b>	4
<b>Operating temperature</b>	-25...+70 °C
Function degrading operating temperature	
$< 0$ °C ambient temperature	support for version VN 01-03 and higher, no limitation
<b>General technical data</b>	see page 35

**BL67 electronic modules**  
**4 digital outputs**  
**BL67-4DO-2A-N**

**Compatible base modules**

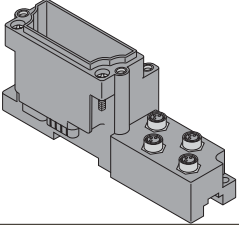
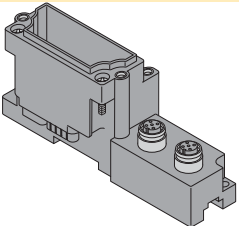
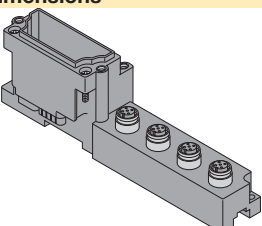
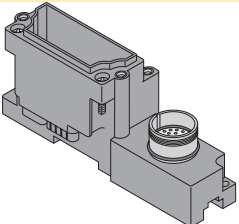
Dimensions	Type	Connection
	<b>6827189 BL67-B-4M8</b> 4 x M8, 3-pole, female  Matching connection cable (for example): SKP32-SSP3/S90 Ident-No. 8008685	F147, F154
	<b>6827186 BL67-B-2M12</b> 2 x M12, 5-pole, female, A-coded <b>6827194 BL67-B-2M12-P</b> 2 x M12, 5-pole, female, A-coded, paired  Matching connection cable (for example): WAK4-2-WAS4/S90 Ident-No. 8006739	F148, F155
	<b>6827187 BL67-B-4M12</b> 4 x M12, 5-pole, female, A-coded  Matching connection cable (for example): WAK4-2-WAS4/S90 Ident-No. 8006739	F149, F156
	<b>6827213 BL67-B-1M23</b> 1 x M23, 12-pole, female  Field-wireable connector (for example): FW-M23ST12Q-G-LT-ME-XX-10 Ident-No. 6604070	F140

2

**Connection**

F147 - Pin configuration

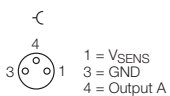

F149 - Pin configuration

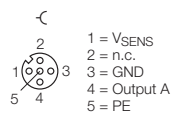

F154 - Wiring diagram

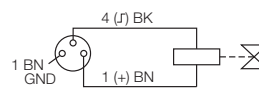

F156 - Wiring diagram

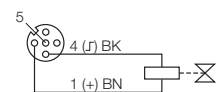

F148 - Pin configuration

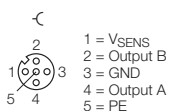

F140 - Pin configuration

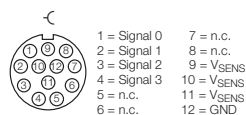

F155 - Wiring diagram

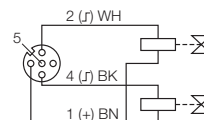

**BL67 electronic modules**  
**8 digital outputs**  
**BL67-8DO-0.5A-N**

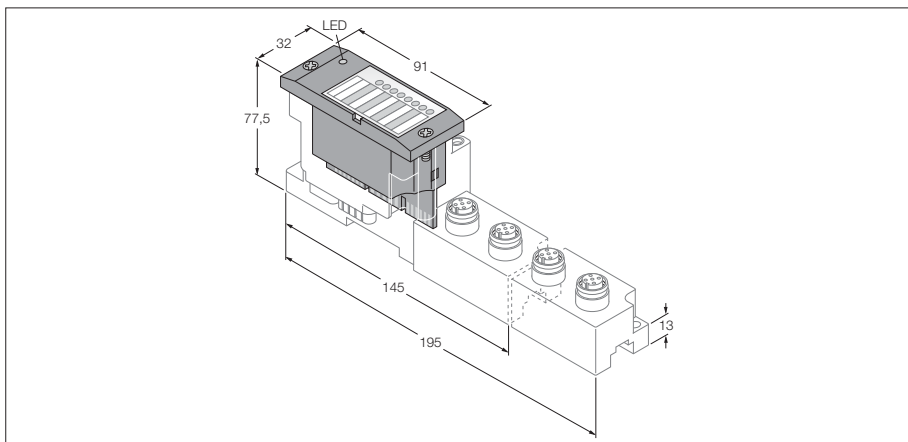

- Independent of the type of field-bus and connection technology used
- Degree of protection IP67
- LEDs for display of status and diagnostics
- Electronics galvanically isolated from the field level via opto-couplers
- 8 digital outputs, 24 VDC
- 0.5 A max.
- npn

<b>Type</b>	BL67-8DO-0.5A-N
Ident-No.	6827209
<b>Number of channels</b>	8
Nominal voltage $V_o$	24 VDC
Rated current from field supply	$\leq 100$ mA
Rated current from module bus	$\leq 30$ mA
Power loss, typical	$\leq 1.5$ W
<b>Output type</b>	npn
Output voltage	24 VDC
Output current per channel	0.5 A
Output delay	3 ms
Load type	resistive, inductive, lamp load
Load resistance, resistive	$> 48 \Omega$
Load resistance, inductive	$< 1.2$ H
Lamp load	$< 3$ W
Switching frequency, resistive	$< 200$ Hz
Inductive switching frequency	$< 2$ Hz
Switching frequency, lamp load	$< 20$ Hz
Short-circuit protection	yes
Simultaneity factor	1
Electrical isolation	electronics for the field level
<b>Number of diagnostic bits</b>	8
<b>Operating temperature</b>	-25...+70 °C
Function degrading operating temperature	
< 0 °C ambient temperature	support for version VN 01-03 and higher, no limitation
> 55 °C circulating air (ventilation)	no limitation
> 55 °C steady ambient air	simultaneity factor 0.5
<b>General technical data</b>	see page 35



**BL67 electronic modules**  
**8 digital outputs**  
**BL67-8DO-0.5A-N**

**Compatible base modules**

Dimensions	Type	Connection
	<b>6827188 BL67-B-8M8</b> 8 x M8, 3-pole, female  Matching connection cable (for example): SKP32-SSP3/S90 Ident-No. 8008685	F147, F154
	<b>6827187 BL67-B-4M12</b> 4 x M12, 5-pole, female  <b>6827195 BL67-B-4M12-P</b> 4 x M12, 5-pole, female, paired  Matching connection cable (for example): WAK4-2-WAS4/S90 Ident-No. 8006739	F148, F155
	<b>6827213 BL67-B-1M23</b> 1 x M23, 12-pole, female  Field-wireable connector (for example): FW-M23ST12Q-G-LT-ME-XX-10 Ident-No. 6604070	F145

2

**Connection**

F147 - Pin configuration

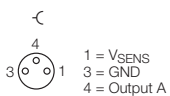

F145 - Pin configuration

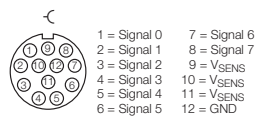

F155 - Wiring diagram

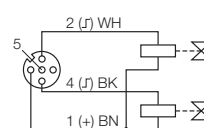

F148 - Pin configuration

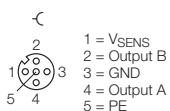

F154 - Wiring diagram

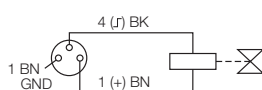

**BL67 electronic modules**  
**Relay Normally Open**  
**BL67-8DO-R-NO**

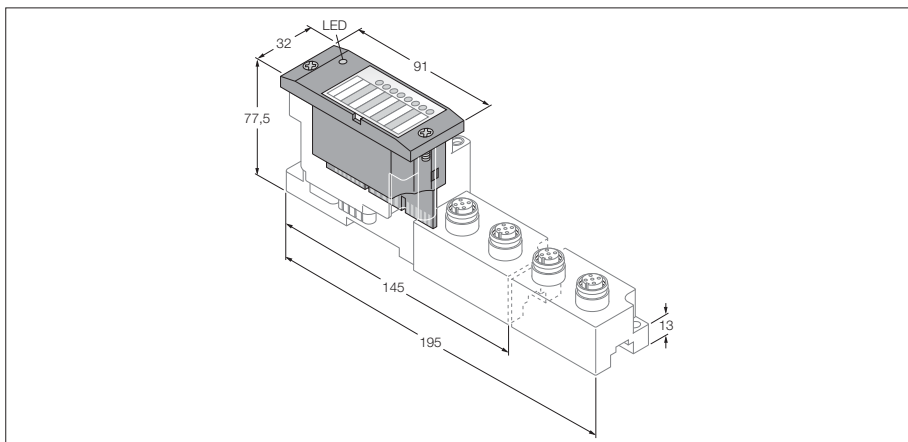

- Independent of the type of field-bus and connection technology used
- Degree of protection IP67
- LEDs for status display
- Electronics galvanically isolated from the field level via opto-couplers
- 8 isolated relay outputs
- 0.1 A max.

<b>Type</b>	BL67-8DO-R-NO
Ident-No.	6827277
<b>Number of channels</b>	8
Rated current from module bus	≤ 50 mA
Power loss, typical	≤ 2 W
<b>Output type</b>	relays
Switching resistor	< 31 Ω
Output current per channel	100 mA at 25 °C / 50 mA at 55 °C
Output delay	3 ms
Load type	resistive, TTL logic
Switching frequency, resistive	< 200 Hz
Short-circuit protection	no
Simultaneity factor	1
Electrical isolation	Electronics to the field level 250 VAC, channel to channel 50 VAC, channel to PE 100 VAC
<b>Operating temperature</b>	-25...+70 °C
Function degrading operating temperature	
> 55 °C circulating air (ventilation)	max. 25 mA output current per channel
> 55 °C steady ambient air	max. 25 mA output current per channel
<b>General technical data</b>	see page 35

**BL67 electronic modules**  
**Relay Normaly Open**  
**BL67-8DO-R-NO**

**Compatible base modules**

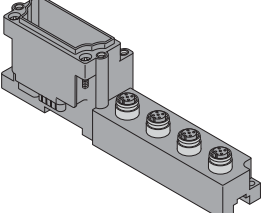
Dimensions	Type	Connection
	<p><b>6827195 BL67-B-4M12-P</b> 4 x M12, 5-pole, female, paired</p> <p>Matching connection cable (for example): WAK4-2-WAS4/S90 Ident-No. 8006739</p>	<p>F157, F158</p>

**Connection**

F157 - Pin configuration

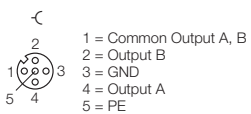

F158 - Wiring diagram

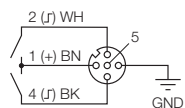

**BL67 electronic modules**  
**4 digital inputs, 4 digital outputs**  
**BL67-4DI4DO-PD**

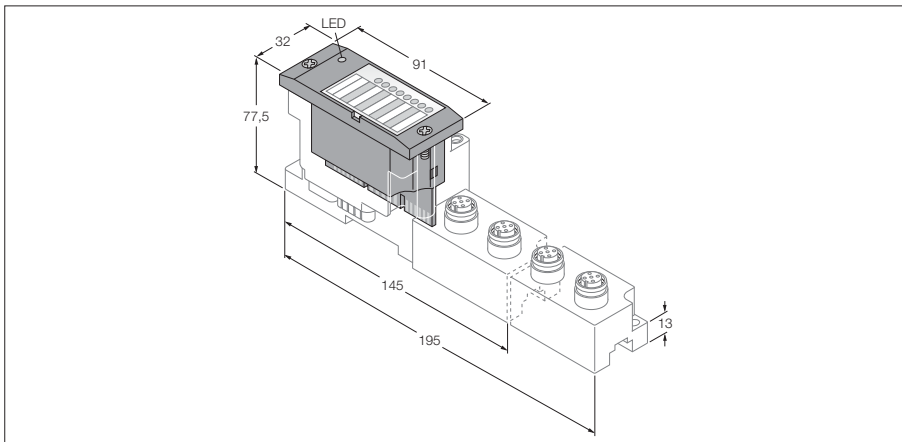

- Independent of the type of field-bus and connection technology used
- Degree of protection IP67
- LEDs for display of status and diagnostics
- Electronics galvanically isolated from the field level via opto-couplers
- 4 digital inputs, 24 VDC
- 4 digital outputs, 24 VDC, 0.5 A max.
- pnp
- Channel diagnostics
- Selection of filter times
- Input inverting possible

<b>Type</b>	BL67-4DI4DO-PD
Ident-No.	6827203
<b>Number of channels</b>	8
Nominal voltage $V_0$	24 VDC
Rated current from field supply	$\leq 100$ mA
Rated current from module bus	$\leq 30$ mA
Power loss, typical	$\leq 1.5$ W
<b>Input type</b>	pnp
Type of input diagnostics	channel diagnostics
Low level signal voltage	$< 4.5$ V
High level signal voltage	7...30 V
Low level signal current	$< 1.5$ mA
High level signal current	2.1...3.7 mA
Input delay	0.25; 2.5 ms
Electrical isolation	electronics for the field level
<b>Output type</b>	pnp
Output voltage	24 VDC
Output current per channel	0.5 A
Output delay	3 ms
Load type	resistive, inductive, lamp load
Load resistance, resistive	$> 48 \Omega$
Load resistance, inductive	$< 1.2$ H
Lamp load	$< 3$ W
Switching frequency, resistive	$< 200$ Hz
Inductive switching frequency	$< 2$ Hz
Switching frequency, lamp load	$< 20$ Hz
Simultaneity factor	1
Electrical isolation	electronics for the field level
<b>Number of diagnostic bits</b>	8
Number of parameter bytes	4
<b>Operating temperature</b>	-25...+70 °C
Function degrading operating temperature	
$< 0$ °C ambient temperature	support for version VN 01-03 and higher, no limitation
<b>General technical data</b>	see page 35

**BL67 electronic modules**  
**4 digital inputs, 4 digital outputs**  
**BL67-4DI4DO-PD**

**Compatible base modules**

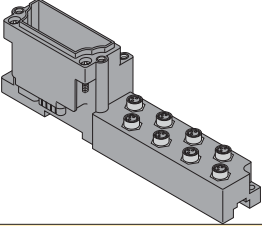
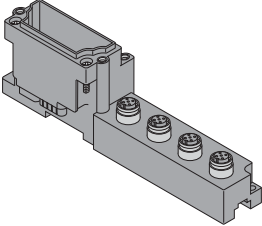
Dimensions	Type	Connection
	<b>6827188 BL67-B-8M8</b> 8 x M8, 3-pole, female  Matching connection cable (for example): SKP32-SSP3/S90 Ident-No. 8008685	F159, F141, F150
	<b>6827187 BL67-B-4M12</b> 4 x M12, 5-pole, female  Matching connection cable (for example): WAK4-2-WAS4/S90 Ident-No. 8006739  Possible applications: Triggering light screen Pick To Light for work sequence control.	F160, F161
	<b>6827195 BL67-B-4M12-P</b> 4 x M12, 5-pole, female, paired  Matching connection cable (for example): WAK4-2-WAS4/S90 Ident-No. 8006739	F160, F144, F151

2

**Connection**

F159 - Pin configuration

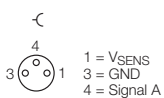

F141 - Wiring diagram, slot 0 to 3

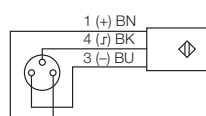

F144 - Wiring diagram, slot 0 and 1

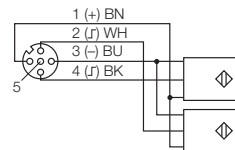

F151 - Wiring diagram, slot 2 and 3

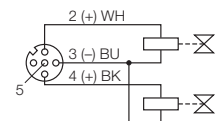

F160 - Pin configuration

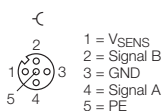

F161 - Wiring diagram, slot 0 to 3

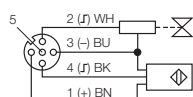

F150 - Wiring diagram, slot 0 to 3

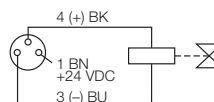

## BL67 electronic modules

### 8 configurable digital channels

### BL67-8XSG-PD

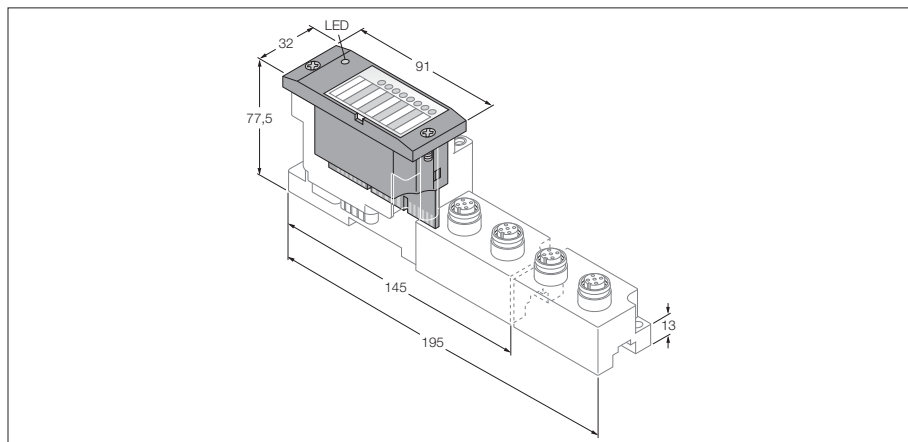

- Independent of the type of field-bus and connection technology used
- Degree of protection IP67
- LEDs for display of status and diagnostics
- Electronics galvanically isolated from the field level via opto-couplers
- 8 configurable digital channels
- 24 VDC, pnp
- 0.5 A max.
- Channel diagnostics
- Selection of filter times
- Input inverting possible

<b>Type</b>	BL67-8XSG-PD
Ident-No.	6827208
<b>Number of channels</b>	8
Nominal voltage $V_0$	24 VDC
Rated current from field supply	$\leq 100$ mA
Rated current from module bus	$\leq 30$ mA
Power loss, typical	$\leq 1.5$ W
<b>Input type</b>	pnp
Type of input diagnostics	channel diagnostics
Low level signal voltage	$< 4.5$ V
High level signal voltage	7...30 V
Low level signal current	$< 1.5$ mA
High level signal current	2.1...3.7 mA
Input delay	0.25; 2.5 ms
Electrical isolation	electronics for the field level
<b>Output type</b>	pnp
Output voltage	24 VDC
Output current per channel	0.5 A
Output delay	3 ms
Load type	resistive, inductive, lamp load
Load resistance, resistive	$> 48 \Omega$
Load resistance, inductive	$< 1.2$ H
Lamp load	$< 3$ W
Switching frequency, resistive	$< 200$ Hz
Inductive switching frequency	$< 2$ Hz
Switching frequency, lamp load	$< 20$ Hz
Simultaneity factor	1
Electrical isolation	electronics for the field level
<b>Number of diagnostic bits</b>	12
Number of parameter bytes	8
<b>Operating temperature</b>	-25...+70 °C
Function degrading operating temperature	
$< 0$ °C ambient temperature	support for version VN 01-03 and higher, no limitation
$> 55$ °C circulating air (ventilation)	no limitation
$> 55$ °C steady ambient air	simultaneity factor 0.5
<b>General technical data</b>	see page 35

**BL67 electronic modules**  
**8 configurable digital channels**  
**BL67-8XSG-PD**

**Compatible base modules**

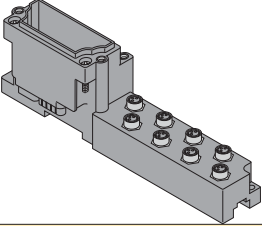
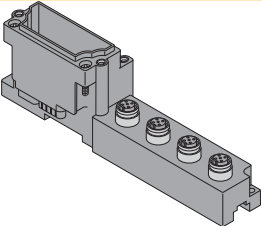
Dimensions	Type	Connection
	<b>6827188 BL67-B-8M8</b> 8 x M8, 3-pole, female  Matching connection cable (for example): SKP32-SSP3/S90 Ident-No. 8008685	F159, F141, F150
	<b>6827187 BL67-B-4M12</b> 4 x M12, 5-pole, female  <b>6827195 BL67-B-4M12-P</b> 4 x M12, 5-pole, female, paired  Matching connection cable (for example): WAK4-2-WAS4/S90 Ident-No. 8006739	F160, F161, F162, F144, F151

2

**Connection**

F159 - Pin configuration

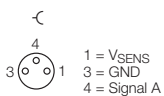

F141 - Wiring diagram

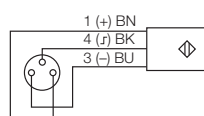

F150 - Wiring diagram

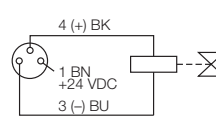

F144 - Wiring diagram

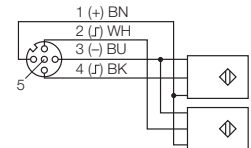

F160 - Pin configuration

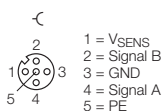

F161 - Wiring diagram

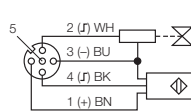

F162 - Wiring diagram

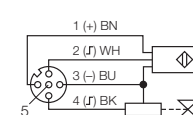

F151 - Wiring diagram

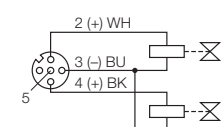

**BL67 electronic modules**  
**2 analogue inputs**  
**BL67-2AI-I**

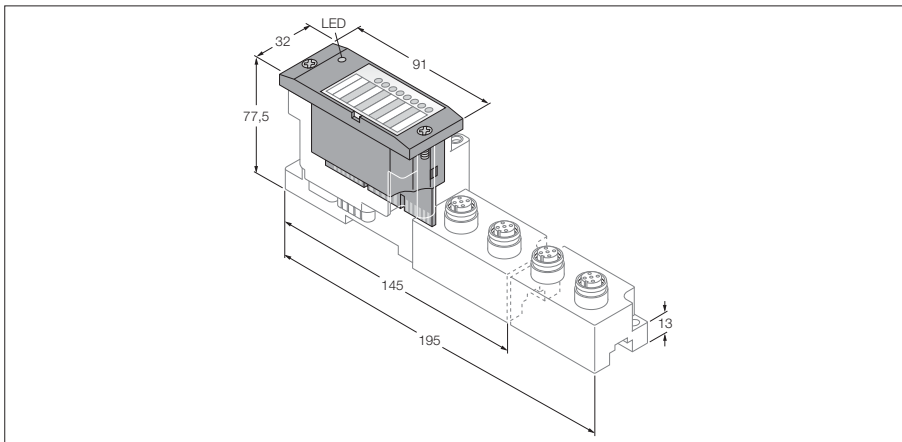

- Independent of the type of field-bus and connection technology used
- Degree of protection IP67
- LEDs for display of status and diagnostics
- Electronics galvanically isolated from the field level via opto-couplers
- 2 analogue inputs 0/4...20 mA

<b>Type</b>	BL67-2AI-I
Ident-No.	6827175
<b>Number of channels</b>	2
Nominal voltage $V_i$	24 VDC
Rated current from field supply	$\leq 12$ mA
Rated current from module bus	$\leq 35$ mA
Power loss, typical	$\leq 1$ W
<b>Inputs</b>	
Input type	0/4...20 mA
Input resistance	$< 0.125$
<b>Maximum limiting frequency, analogue</b>	$< 50$ Hz
Basic fault limit at 23 °C	$< 0.2$ %
Repeatability	0.05 %
Temperature coefficient	$< 300$ ppm/°C of full scale
Resolution	16 Bit
Measuring principle	Sigma Delta
Measured-value display	16 bit signed integer 12 bit full range left justified
<b>Number of diagnostic bytes</b>	2
Number of parameter bytes	2
<b>Operating temperature</b>	-25...+70 °C
<b>General technical data</b>	see page 35



**BL67 electronic modules**  
**2 analogue inputs**  
**BL67-2AI-I**

**Compatible base modules**

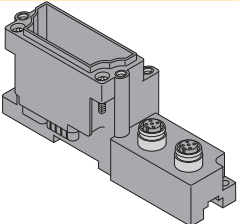
Dimensions	Type	Connection
	<p><b>6827186 BL67-B-2M12</b> 2 x M12, 5-pole, female, a-coded</p> <p>Matching connection cable (for example): WAK4.5-2-WAS4.5/S57 Ident-No. 8016988</p>	<p>F163, F164, F165, F166</p>

**Connection**

F163 - Pin configuration

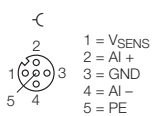

F165 - 3-wire technology

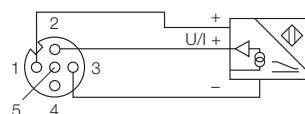

F164 - 2-wire technology

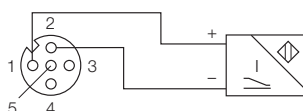

F166 - 4-wire technology

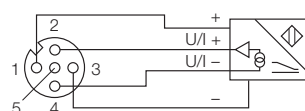

**BL67 electronic modules**  
**2 analogue inputs**  
**BL67-2AI-V**

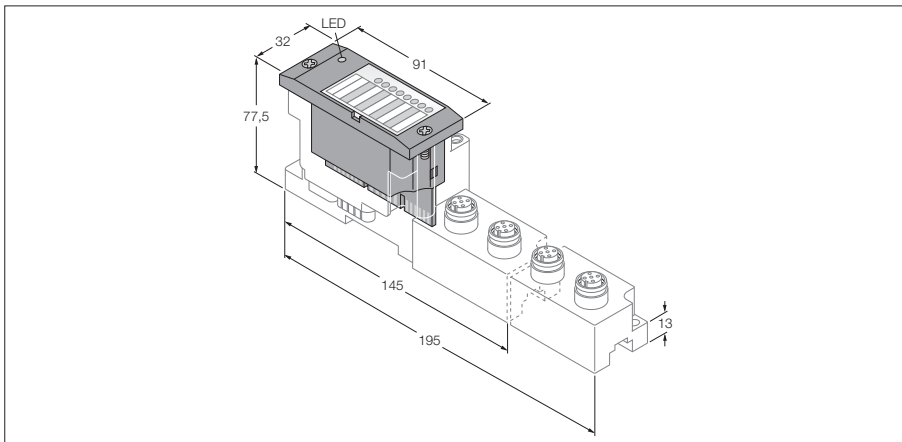

- Independent of the type of field-bus and connection technology used
- Degree of protection IP67
- LEDs for display of status and diagnostics
- Electronics galvanically isolated from the field level via opto-couplers
- 2 analogue inputs  
-10/0...+10 VDC

<b>Type</b>	BL67-2AI-V
Ident-No.	6827176
<b>Number of channels</b>	2
Nominal voltage $V_i$	24 VDC
Rated current from field supply	$\leq 12$ mA
Rated current from module bus	$\leq 35$ mA
Power loss, typical	$\leq 1$ W
<b>Inputs</b>	
Input type	-10/0...+10 VDC
Input resistance	$< 98.5$
<b>Maximum limiting frequency, analogue</b>	$< 50$ Hz
Basic fault limit at 23 °C	$< 0.2$ %
Repeatability	0.05 %
Temperature coefficient	$< 150$ ppm/°C of full scale
Resolution	16 Bit
Measuring principle	Sigma Delta
Measured-value display	16 bit signed integer 12 bit full range left justified
<b>Number of diagnostic bytes</b>	2
Number of parameter bytes	2
<b>Operating temperature</b>	-25...+70 °C
<b>General technical data</b>	see page 35

**BL67 electronic modules**  
**2 analogue inputs**  
**BL67-2AI-V**

**Compatible base modules**

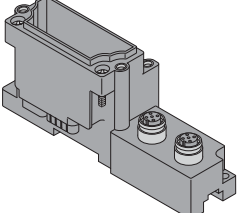
Dimensions	Type	Connection
	<p><b>6827186 BL67-B-2M12</b> 2 x M12, 5-pole, female, a-coded</p> <p>Matching connection cable (for example): WAK4.5-2-WAS4.5/S57 Ident-No. 8016988</p>	<p>F163, F164, F165, F166</p>

**Connection**

F163 - Pin configuration

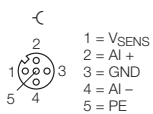

F163 - 3-wire technology

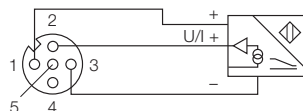

F163 - 2-wire technology

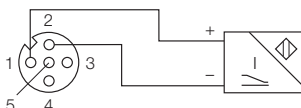

F166 - 4-wire technology

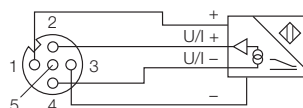

**BL67 electronic modules**  
**4 analogue inputs**  
**BL67-4AI-V/I**

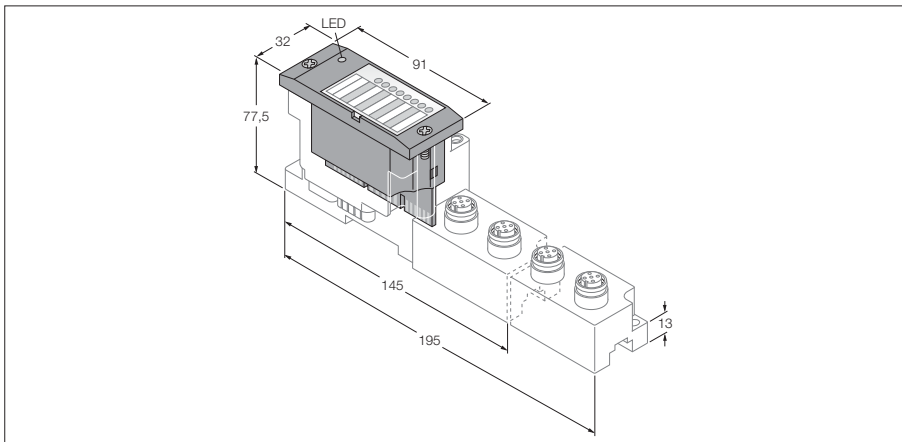

- Independent of the type of field-bus and connection technology used
- Degree of protection IP67
- LEDs for display of status and diagnostics
- Electronics galvanically isolated from the field level via opto-couplers
- 4 analogue inputs
- 0/4...20 mA or
- -10/0...+10 VDC
- Selectable per channel

<b>Type</b>	BL67-4AI-V/I
Ident-No.	6827222
<b>Number of channels</b>	4
Nominal voltage $V_i$	24 VDC
Rated current from field supply	$\leq 12$ mA
Rated current from module bus	$\leq 35$ mA
Power loss, typical	$\leq 1$ W
<b>Inputs</b>	
Input type	0/4 ... 20 mA or -10/0 ... +10 VDC
Input resistance	0.125 or 98.5 k $\Omega$
<b>Maximum limiting frequency, analogue</b>	< 20 Hz
Basic fault limit at 23 °C	< 0.3 %
Repeatability	0.05 %
Temperature coefficient	< 300 ppm/°C of full scale
Resolution	16 Bit
Measuring principle	Sigma Delta
Measured-value display	16 bit signed integer 12 bit full range left justified
<b>Number of diagnostic bytes</b>	4
Number of parameter bytes	4
<b>Operating temperature</b>	-25...+70 °C
<b>General technical data</b>	see page 35

**BL67 electronic modules**  
**4 analogue inputs**  
**BL67-4AI-V/I**

**Compatible base modules**

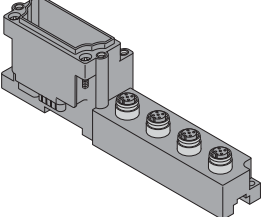
Dimensions	Type	Connection
	<p><b>6827187 BL67-B-4M12</b> 4 x M12, 5-pole, female, a-coded</p> <p>Matching connection cable (for example): WAK4.5-2-WAS4.5/S57 Ident-No. 8016988</p>	<p>F163, F164, F165, F166</p>

**Connection**

F163 - Pin configuration

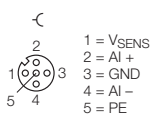

F165 - 3-wire technology

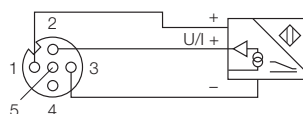

F164 - 2-wire technology

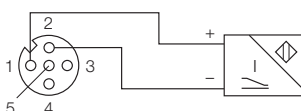

F166 - 4-wire technology

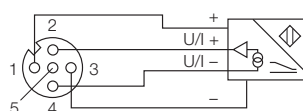

**BL67 electronic modules**  
**2 analogue inputs for temperature measurement**  
**BL67-2AI-PT**

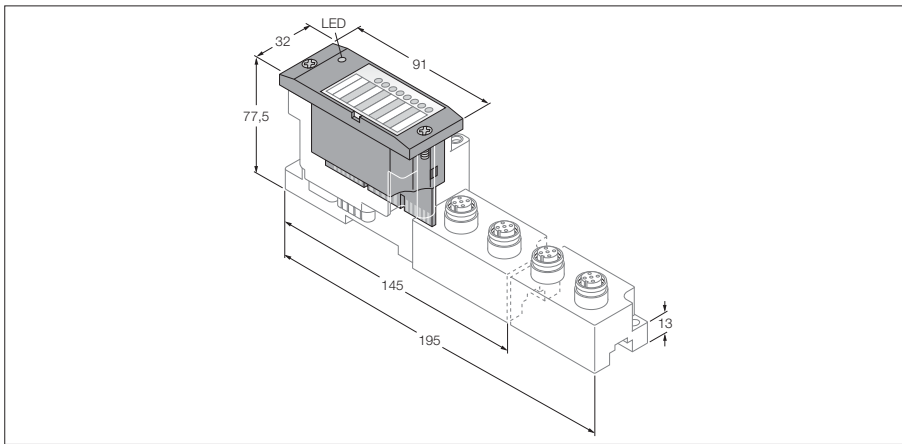

- Independent of the type of field-bus and connection technology used
- Degree of protection IP67
- LEDs for display of status and diagnostics
- Electronics galvanically isolated from the field level via opto-couplers
- 2 analogue inputs for PT100, PT200, PT500 and PT1000 as well as for Ni100 and Ni1000

<b>Type</b>	BL67-2AI-PT
Ident-No.	6827177
<b>Number of channels</b>	2
Nominal voltage $V_i$	24 VDC
Rated current from field supply	$\leq 30$ mA
Rated current from module bus	$\leq 45$ mA
Power loss, typical	$\leq 1$ W
<b>Inputs</b>	
Input type	PT100, PT200, PT500, PT1000, Ni100, Ni1000
<b>Basic fault limit at 23 °C</b>	$< 0.2$ %
Repeatability	0.05 %
Temperature coefficient	$< 300$ ppm/°C of full scale
Resolution	16 Bit
Measured-value display	16 bit signed integer 12 bit full range left justified
<b>Number of diagnostic bytes</b>	2
Number of parameter bytes	4
<b>Operating temperature</b>	-25...+70 °C
<b>General technical data</b>	see page 35

**BL67 electronic modules**  
**2 analogue inputs for temperature measurement**  
**BL67-2AI-PT**

**Compatible base modules**

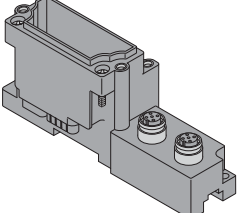
Dimensions	Type	Connection
	<p><b>6827186 BL67-B-2M12</b>                  2 x M12, 5-pole, female, a-coded</p> <p>Matching connection cable (for example):                  WAK4.5-2-WAS4.5/S57                  Ident-No. 8016988</p>	<p>F167, F168, F169</p>

**2**

**Connection**

F167 - Pin configuration

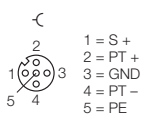

F169 - 3-wire technology

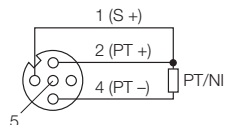

F168 - 2-wire technology

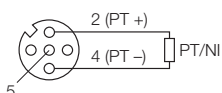

**BL67 electronic modules**  
**2 analogue inputs for temperature measurement**  
**BL67-2AI-TC**

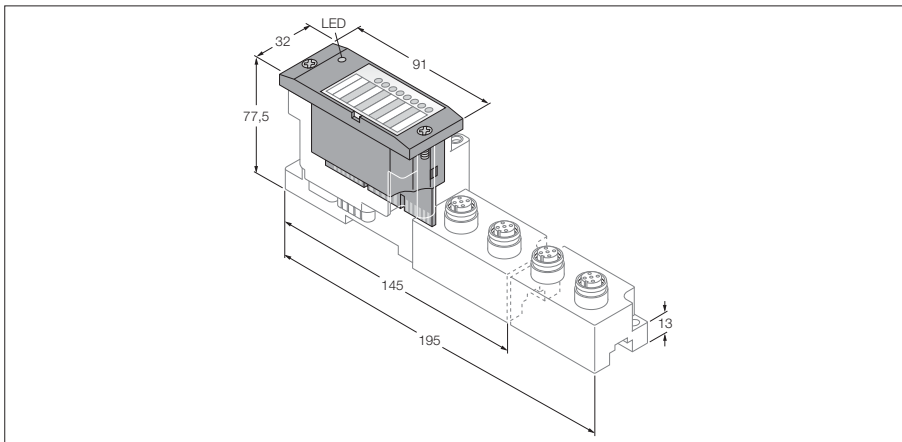

- Independent of the type of field-bus and connection technology used
- Degree of protection IP67
- LEDs for display of status and diagnostics
- Electronics galvanically isolated from the field level via opto-couplers
- 2 analogue inputs for connection of thermoelements, types B, E, J, K, N, R, S and T
- Cold junction point compensation via Pt1000 probe in a special connector

<b>Type</b>	BL67-2AI-TC
Ident-No.	6827178
<b>Number of channels</b>	2
Nominal voltage $V_i$	24 VDC
Rated current from field supply	$\leq 30$ mA
Rated current from module bus	$\leq 35$ mA
Power loss, typical	$\leq 1$ W
<b>Inputs</b>	
Input type	types B, E, J, K, N, R, S, T
<b>Voltage resolution</b>	$\pm 50$ mV: $< 2$ $\mu$ V
Basic fault limit at 23 °C	$< 0.2$ %
Repeatability	0.05 %
Temperature coefficient	$< 300$ ppm/°C of full scale
Resolution	16 Bit
Measured-value display	16 bit signed integer 12 bit full range left justified
<b>Number of diagnostic bytes</b>	2
Number of parameter bytes	2
<b>Operating temperature</b>	-25...+70 °C
<b>General technical data</b>	see page 35



**BL67 electronic modules**  
**2 analogue inputs for temperature measurement**  
**BL67-2AI-TC**

**Compatible base modules**

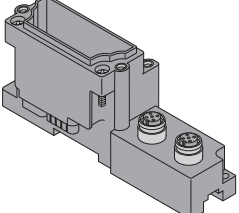
Dimensions	Type	Connection
	<p><b>6827186 BL67-B-2M12</b>                  2 x M12, 5-pole, female, a-coded</p> <p>Matching connection with Pt1000 probe                  for the cold junction point compensation:                  BL67-WAS5-THERMO                  Ident-No. 6827197</p>	<p>F170, F171</p>

**Connection**

F170 - Pin configuration

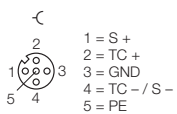

F171 - Wiring diagram

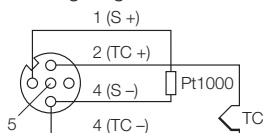

**BL67 electronic modules**  
**2 analogue outputs**  
**BL67-2AO-I**

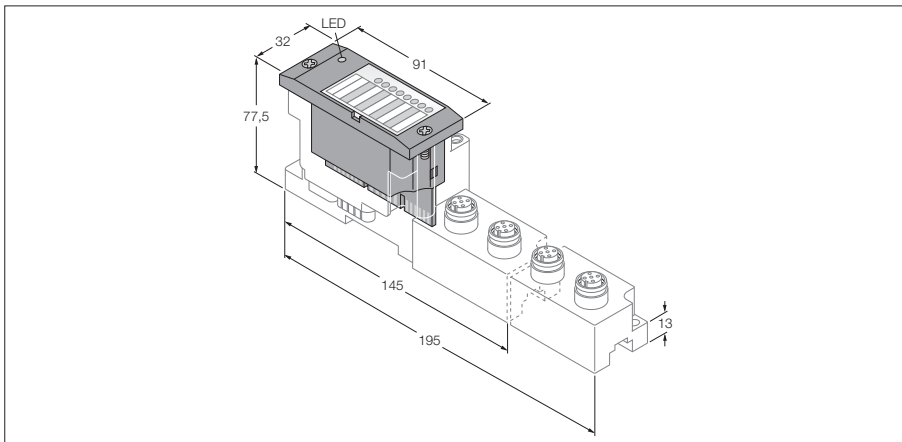

- Independent of the type of field-bus and connection technology used
- Degree of protection IP67
- LEDs for display of status and diagnostics
- Electronics galvanically isolated from the field level via opto-couplers
- 2 analogue outputs 0/4...20 mA

<b>Type</b>	BL67-2AO-I
Ident-No.	6827179
<b>Number of channels</b>	2
Nominal voltage $V_i$	24 VDC
Rated current from field supply	$\leq 50$ mA
Rated current from module bus	$\leq 40$ mA
Power loss, typical	$\leq 1$ W
<b>Outputs</b>	
Output type	0/4...20 mA
Load resistance, resistive	$< 0.45$ k $\Omega$
Load resistance, inductive	$< 1$ mH
<b>Transmission frequency</b>	$< 200$ Hz
Basic fault limit at 23 °C	$< 0.2$ %
Repeatability	0.05 %
Temperature coefficient	$< 150$ ppm/°C of full scale
Resolution	16 Bit
Measured-value display	16 bit signed integer 12 bit full range left justified
<b>Number of parameter bytes</b>	6
<b>Operating temperature</b>	-25...+70 °C
<b>General technical data</b>	see page 35

**BL67 electronic modules**  
**2 analogue outputs**  
**BL67-2AO-I**

**Compatible base modules**

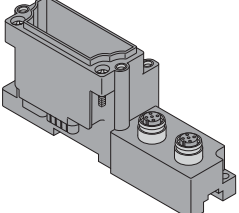
Dimensions	Type	Connection
	<p><b>6827186 BL67-B-2M12</b> 2 x M12, 5-pole, female, a-coded</p> <p>Matching connection cable (for example): WAK4.5-2-WAS4.5/S57 Ident-No. 8016988</p>	<p>F172</p>

**Connection**

F172 - Pin configuration

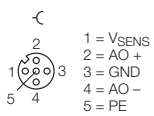

**BL67 electronic modules**  
**2 analogue outputs**  
**BL67-2AO-V**

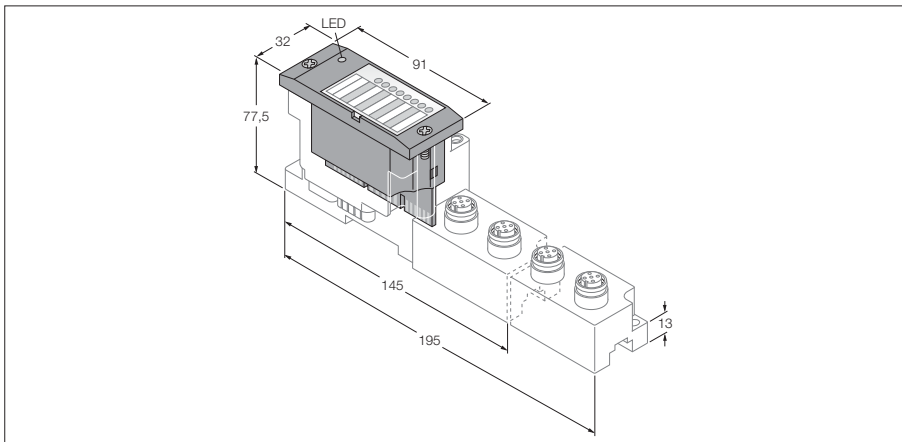

- Independent of the type of field-bus and connection technology used
- Degree of protection IP67
- LEDs for display of status and diagnostics
- Electronics galvanically isolated from the field level via opto-couplers
- 2 analogue input -10/0...+10 VDC

<b>Type</b>	BL67-2AO-V
Ident-No.	6827180
<b>Number of channels</b>	2
Nominal voltage $V_i$	24 VDC
Rated current from field supply	$\leq 50$ mA
Rated current from module bus	$\leq 60$ mA
Power loss, typical	$\leq 1$ W
<b>Outputs</b>	$\leq 1$ W
Output type	-10/0...+10 VDC
Load resistance, resistive	$> 1$ k $\Omega$
Load resistance, capacitive	$> 1$ $\mu$ F
<b>Transmission frequency</b>	$< 100$ Hz
Basic fault limit at 23 °C	$< 0.2$ %
Repeatability	0.05 %
Temperature coefficient	$< 300$ ppm/°C of full scale
Resolution	16 Bit
Measured-value display	16 bit signed integer 12 bit full range left justified
<b>Number of parameter bytes</b>	6
<b>Operating temperature</b>	-25...+70 °C
<b>General technical data</b>	see page 35

**BL67 electronic modules**  
**2 analogue outputs**  
**BL67-2AO-V**

**Compatible base modules**

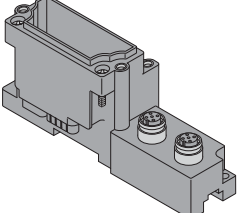
Dimensions	Type	Connection
	<p><b>6827186 BL67-B-2M12</b> 2 x M12, 5-pole, female, a-coded</p> <p>Matching connection cable (for example): WAK4.5-2-WAS4.5/S57 Ident-No. 8016988</p>	<p>F172</p>

**Connection**

F172 - Pin configuration

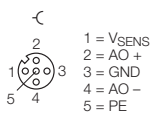

**BL67 electronic modules**  
**RS232 interface**  
**BL67-1RS232**

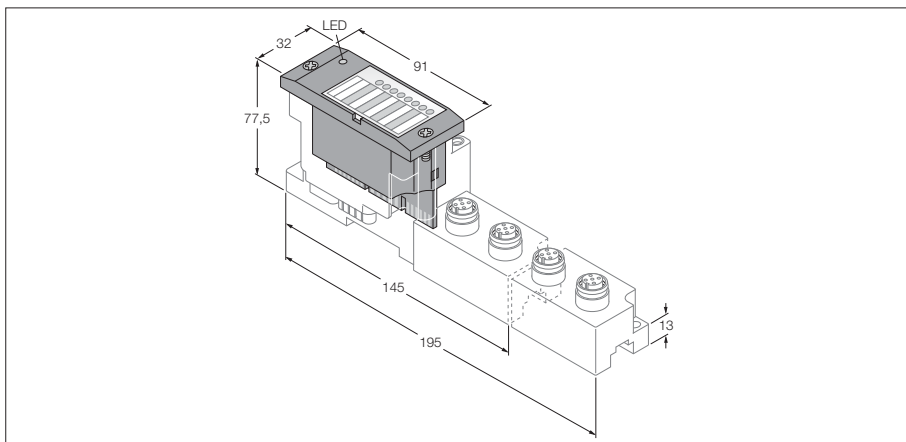

- Independent of the type of field-bus and connection technology used
- Degree of protection IP67
- LEDs for display of status and diagnostics
- Electronics galvanically isolated from the field level via opto-couplers
- Transmission of serial data via RS232 interface
- For connection of different devices, such as printers, scanners or bar code readers

<b>Type</b>	BL67-1RS232
Ident-No.	6827181
<b>Number of channels</b>	1
Nominal voltage $V_i$	24 VDC
Rated current from field supply	$\leq 50$ mA
Rated current from module bus	$\leq 140$ mA
Power loss, typical	$\leq 1$ W
<b>Inputs / Outputs</b>	
Transmission level active (U RS1)	-15 to -3 VDC
Transmission level inactive (URSO)	3 to 15 VDC
Common-mode range (UGL)	-7 to 12 VDC
Transmission signals	RxD, TxD, RTS, CTS
Data buffer received	128 Byte
Send data buffer	64 Byte
Connection type	full duplex
Transmission rate	300 to 115200 bps
Parameter	transmission rate, diagnostics, data bits, stop bits, XON - character, XOFF - character, parity, flow control
Cable length	15 m
Electrical isolation	isolation of electronics and field level via opto-couplers
<b>Number of diagnostic bytes</b>	1
Number of parameter bytes	4
<b>Operating temperature</b>	-25...+70 °C
<b>General technical data</b>	see page 35

**BL67 electronic modules**  
**RS232 interface**  
**BL67-1RS232**

**Compatible base modules**

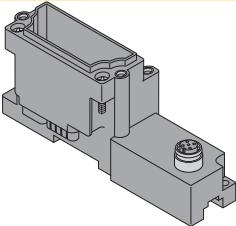
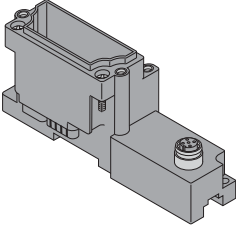
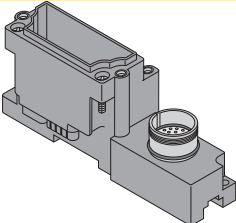
Dimensions	Type	Connection
	<b>6827185 BL67-B-1M12</b> <b>1 x M12, 5-pole, female</b>  Shielded cable with unterminated end (example): WAS4.5-5/S57 Ident-No. 8016986	F173
	<b>6827193 BL67-B-1M12-8</b> <b>1 x M12, 8-pole, female</b>	F174
	<b>6827213 BL67-B-1M23</b> <b>1 x M23, 12-pole, female</b>	F175

2

**Connection**

F173 - Pin configuration

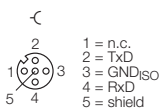

F175 - Pin configuration

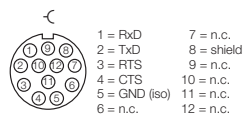

F174 - Pin configuration

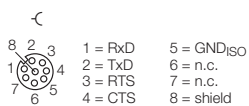

**BL67 electronic modules**  
**RS485/422 interface**  
**BL67-1RS485/422**

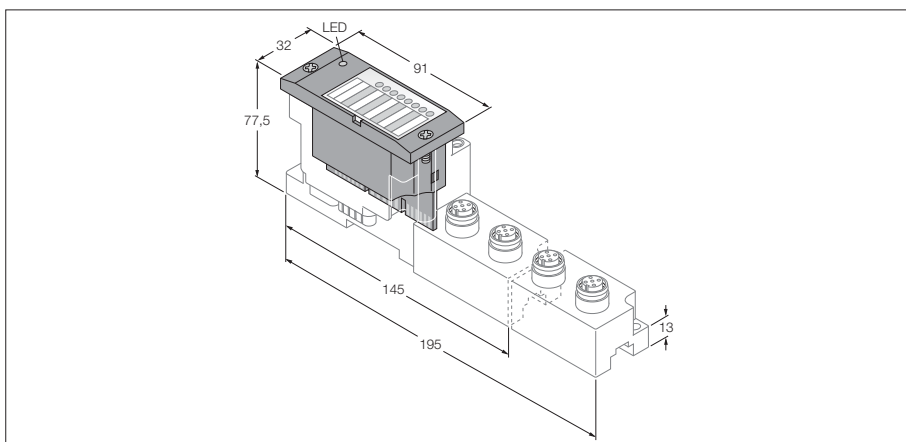

- Independent of the type of field-bus and connection technology used
- Degree of protection IP67
- LEDs for display of status and diagnostics
- Electronics galvanically isolated from the field level via opto-couplers
- Transmission of serial data via RS485/422 interface
- For connection of different devices, such as printers, scanners or bar code readers

<b>Type</b>	BL67-1RS485/422
Ident-No.	6827192
<b>Number of channels</b>	1
Nominal voltage $V_i$	24 VDC
Rated current from field supply	$\leq 50$ mA
Rated current from module bus	$\leq 60$ mA
Power loss, typical	$\leq 1$ W
<b>Inputs / Outputs</b>	
Transmission signals	TxD, RxD
Connection type	2-wire half duplex or 4-wire full duplex
Transmission rate	300 to 115200 bps
Parameter	RS485/422, transmission rate, diagnostics, data bits, stop bits, XON - character, XOFF - character, parity, flow control
Cable length	1000 m
Line impedance	120 $\Omega$
Bus termination	external
Electrical isolation	isolation of electronics and field level via opto-couplers
<b>Number of diagnostic bytes</b>	1
Number of parameter bytes	4
<b>Operating temperature</b>	-25...+70 °C
<b>General technical data</b>	see page 35



**BL67 electronic modules**  
**RS485/422 interface**  
**BL67-1RS485/422**

**Compatible base modules**

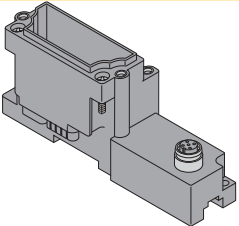
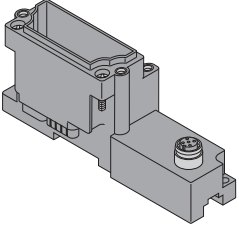
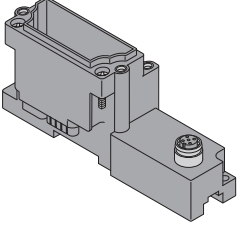
Dimensions	Type	Connection
	<b>6827185 BL67-B-1M12</b> <b>1 x M12, 5-pole, female</b>  Shielded connection cable (for example): WAK4.5-2-WAS4.5/S57 Ident-No. 8016988	F176, F179, F180
	<b>6827193 BL67-B-1M12-8</b> <b>1 x M12, 8-pole, female</b>  Pin configuration comparable with BL67-B-1M12 (see above)	F177
	<b>6827213 BL67-B-1M23</b> <b>1 x M23, 12-pole, female</b>  Pin configuration comparable with BL67-B-1M12 (see above)	F178

2

**Connection**

F176 - Pin configuration

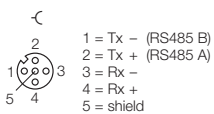

F178 - Pin configuration

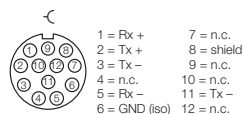

F180 - wiring diagram for RS422

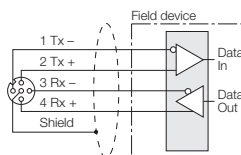

F177 - Pin configuration

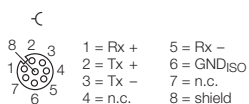

F179 - wiring diagram for RS485

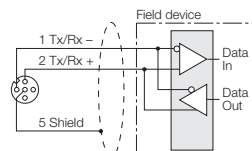

# BL67 electronic modules

## Connection of SSI sensors

### BL67-1SSI

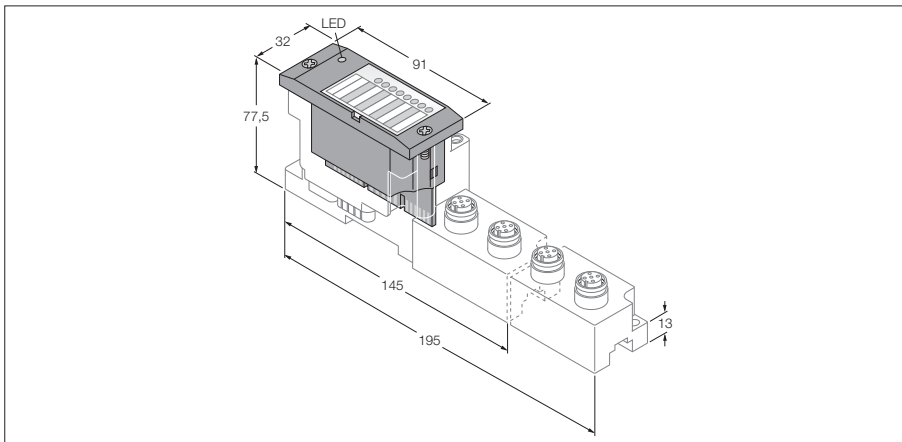

- Independent of the type of field-bus and connection technology used
- Degree of protection IP67
- LEDs for display of status and diagnostics
- Electronics galvanically isolated from the field level via opto-couplers
- Connection of SSI sensors
- Maximum bit transmission rate 1 MBit/s

<b>Type</b>	BL67-1SSI
Ident-No.	6827191
<b>Number of channels</b>	1
Nominal voltage $V_i$	24 VDC
Rated current from field supply	$\leq 50$ mA
Rated current from module bus	$\leq 50$ mA
Power loss, typical	$\leq 1$ W
<b>Inputs / Outputs</b>	
Transmission signals	CL, D
Connection type	4-wire full duplex (clock output/signal input)
Transmission rate	62.5 kbps up to 1 Mbps
Parameter	transmission rate, diagnostics, data format (binary / GRAY coded), data frame bits (1-32), number of invalid bits (LSB: 0-15, MSB 0-7)
Cable length	30 m
Electrical isolation	isolation of electronics and field level via opto-couplers
<b>Number of diagnostic bytes</b>	1
Number of parameter bytes	4
<b>Operating temperature</b>	-25...+70 °C
<b>General technical data</b>	see page 35

**BL67 electronic modules**  
**Connection of SSI sensors**  
**BL67-1SSI**

**Compatible base modules**

Dimensions	Type	Connection
	<b>6827193 BL67-B-1M12-8</b> 1 x M12, 8-pole, female	F181, F243
	<b>6827213 BL67-B-1M23</b> 1 x M23, 12-pole, female	F182

2

**Connection**

**F181 - Pin configuration**

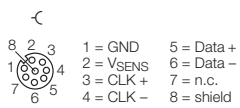

**F243 - Wiring diagram**

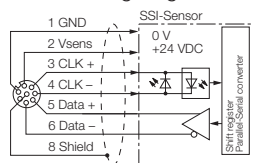

**F182 - Pin configuration**

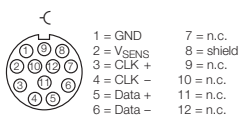

# BL67 electronic modules

## Detection of standard counting signals

### BL67-1CNT/ENC

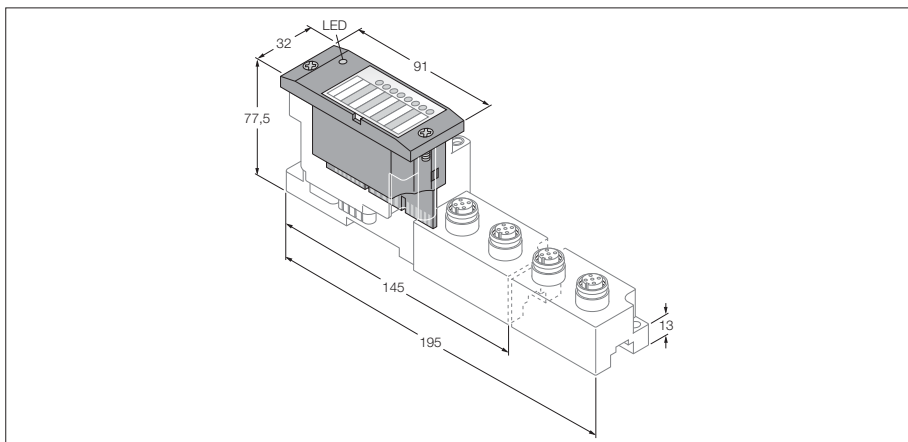

- Independent of the type of field-bus and connection technology used
- Degree of protection IP67
- LEDs for display of status and diagnostics
- Electronics galvanically isolated from the field level via opto-couplers
- Detection of standard counting signals
- 5 VDC differential
- 5... 24 VDC single ended
- 1 digital input, 24 VDC
- 1 digital output, 24 VDC, 0.5 A
- 2 more digital channels, configurable 24 VDC, 0.5 A

<b>Type</b>	BL67-1CNT
Ident-No.	6827224
<b>Number of channels</b>	1
Nominal voltage $V_i$	24 VDC
Rated current from field supply	$\leq 100$ mA
Rated current from module bus	$\leq 50$ mA
Power loss, typical	$\leq 1.2$ W
<b>Inputs / Outputs</b>	
Electrical isolation	isolation of electronics and field level via opto-couplers
<b>Input type</b>	pnp
<b>Output type</b>	pnp
Output current per channel	0.5 A
Output delay	0.2 ms
Load type	resistive
Short-circuit protection	yes
<b>Measuring ranges</b>	
Frequency measurement	up to 250 kHz
Speed measurement	factor parameterisable
Period duration measurement	2 $\mu$ sec
Upper count limit	0x80000000 up to 0xFFFFFFFF
Lower count limit	0x80000000 up to 0xFFFFFFFF
<b>Operating temperature</b>	-25...+70 °C
<b>General technical data</b>	see page 35

**BL67 electronic modules**  
**Detection of standard counting signals**  
**BL67-1CNT / ENC**

**Compatible base modules**

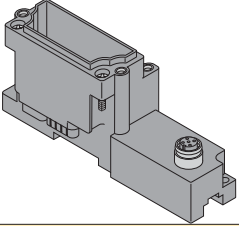
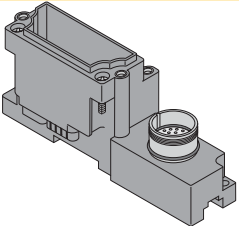
Dimensions	Type	Connection
	<b>6827193 BL67-B-1M12-8</b> 1 x M12, 8-pole, female	F244
	<b>6827213 BL67-B-1M23</b> 1 x M23, 12-pole, female	F245

2

**Connection**

F244 - Pin configuration

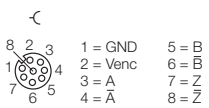

F245 - Pin configuration

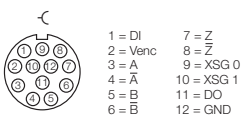

# BL67 electronic modules

## Connection of CANopen nodes

### BL67-1CVI

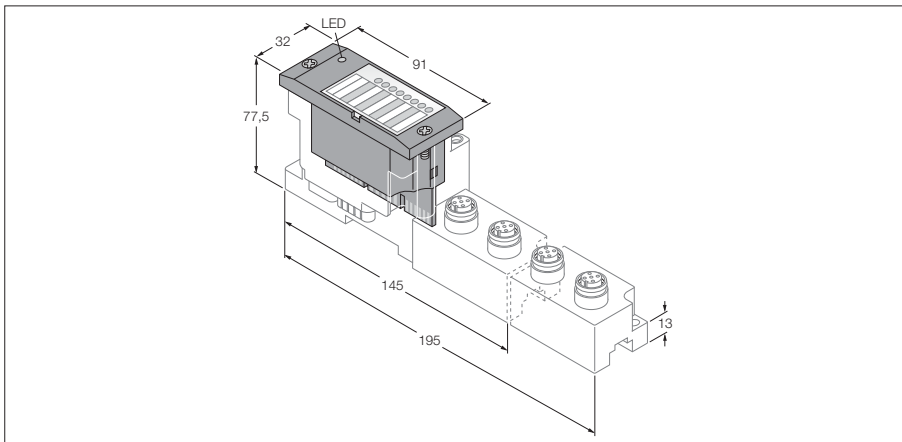

- Independent of the type of field-bus and connection technology used
- Degree of protection IP67
- LEDs for display of status and diagnostics
- Electronics galvanically isolated from the field level via opto-couplers
- Connection of up to 8 CANopen nodes
- 8 byte I/O process data per CVI-module
- max. 4 byte I/O data per node
- max. transmission rate 1 MBit/s

<b>Type</b>	BL67-1CVI
Ident-No.	6827223
<b>Number of channels</b>	1
Nominal voltage $V_i$	24 VDC
Rated current from field supply	$\leq 100$ mA
Rated current from module bus	$\leq 30$ mA
Power loss, typical	$\leq 1$ W
<b>Inputs / Outputs</b>	
Transmission signals	CAN high, CAN low
Connection type	CANopen
Transmission rate	10 kbps up to 1 Mbps
Parameter	transmission rate, diagnostics, bus termination, range of I/O data
Bus termination	internal
Electrical isolation	isolation of electronics and field level via opto-couplers
<b>Number of diagnostic bytes</b>	6
Number of parameter bytes	16
<b>Operating temperature</b>	-25...+70 °C
<b>General technical data</b>	see page 35

**BL67 electronic modules**  
**Connection of CANopen nodes**  
**BL67-1CVI**

**Compatible base modules**

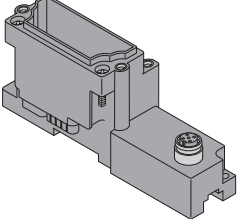
Dimensions	Type	Connection
	<p><b>6827185 BL67-B-1M12</b>                      1 x M12, 5-pole, female</p>	<p>F184</p>

**Connection**

F184 - Pin configuration

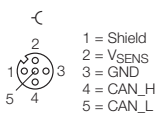

**RFID system**  
**Interface for connection of BL ident write-read heads**  
**BL67-2RFID-A**

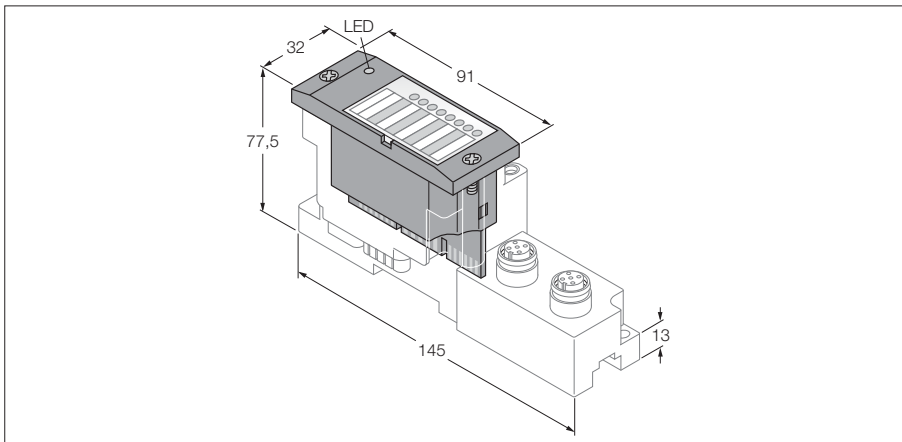

- This module is used in conjunction with the BL67-GW-DPV1
- Degree of protection IP67
- LEDs for display of status and diagnostics
- Electronics galvanically isolated from the field level via opto-couplers
- Connection of 2 BL ident write-read heads
- Transmission rate: 115.2 kbps
- Cable length: 50 m maximum

<b>Type</b>	BL67-2RFID-A
Ident-No.	6827225
<b>Number of channels</b>	2
Nominal voltage $V_i$	24 VDC
Rated current from field supply	$\leq 100$ mA
Rated current from module bus	$\leq 30$ mA
Power loss, typical	$\leq 1$ W
<b>Inputs / Outputs</b>	
Transmission rate	115.2 kbps
Cable length	50 m
Electrical isolation	isolation of electronics and field level via opto-couplers
<b>Simultaneity factor</b>	1
<b>Sensor supply</b>	0.5 A per channel, short-circuit proof
<b>Number of diagnostic bytes</b>	4
Number of parameter bytes	8
Number of input bytes	4
Number of output bytes	4
<b>Operating temperature</b>	-25...+70 °C
<b>General technical data</b>	see page 35

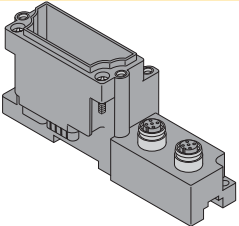

**Compatible base modules**

Dimensions	Type	Connection
	<p><b>6827186 BL67-B-2M12</b> 2 x M12, 5-pole, female, a-coded</p> <p>Matching connection cable (for example): RK4.5T5-RS4.5T/S2500 Ident-No. 6699201</p>	<p>F185</p>

**2**

**Connection**

F185 - Pin configuration

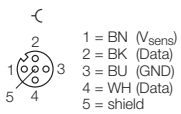

**RFID system**  
**Interface for connection of BL ident write-read heads**  
**BL67-2RFID-C**

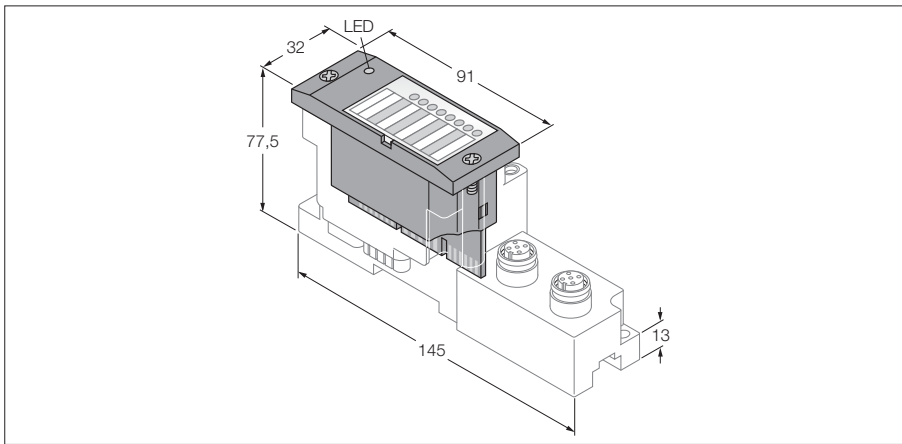

- This module is used i.e. with Gateway BL67-GW-DPV1 (sensing mode DPV0)
- Degree of protection IP67
- LEDs for display of status and diagnostics
- Electronics galvanically isolated from the field level via opto-couplers
- Connection of 2 BL ident write-read heads
- Transmission rate: 115.2 kbps
- Cable length: 50 m maximum

<b>Type</b>	BL67-2RFID-C
Ident-No.	6827238
<b>Number of channels</b>	2
Nominal voltage $V_i$	24 VDC
Rated current from field supply	$\leq 100$ mA
Rated current from module bus	$\leq 30$ mA
Power loss, typical	$\leq 1$ W
<b>Inputs / Outputs</b>	
Transmission rate	115.2 kbps
Cable length	50 m
Electrical isolation	isolation of electronics and field level via opto-couplers
<b>Simultaneity factor</b>	1
<b>Sensor supply</b>	0.5 A per channel, short-circuit proof
<b>Number of diagnostic bytes</b>	4
Number of parameter bytes	8
Number of input bytes	32
Number of output bytes	32
<b>Operating temperature</b>	-25...+70 °C
<b>General technical data</b>	see page 35

**Compatible base modules**

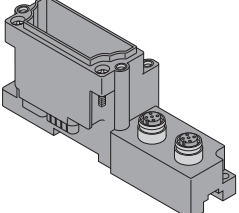
Dimensions	Type	Connection
	<p><b>6827186 BL67-B-2M12</b> 2 x M12, 5-pole, female, a-coded</p> <p>Matching connection cable (for example): RK4.5T5-RS4.5T/S2500 Ident-No. 6699201</p>	<p>F185</p>

**2**

**Connection**

F185 - Pin configuration



# DIGITAL ANALOGUE TECHNOLOGY



CANopen



Modbus TCP

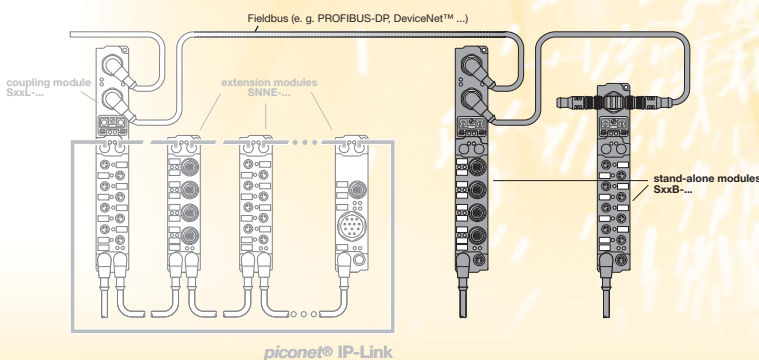
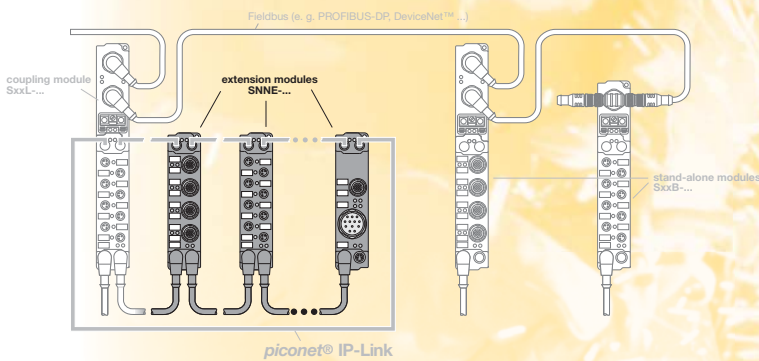
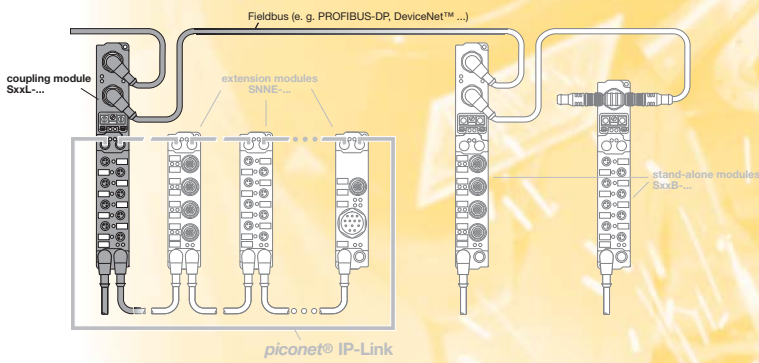
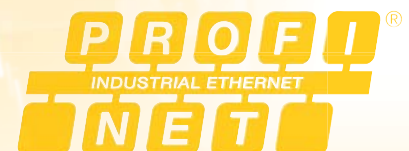
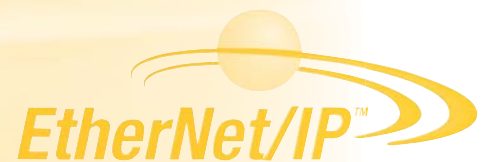

# **piconet® – Modular fieldbus I/O system in IP67**

**TURCK**

Industrial  
Automation

<b>piconet® – Overview</b>	<b>Page</b>
<i>piconet®</i> – System concept	110
<i>piconet®</i> – I/O-ASSISTANT	112
<i>piconet®</i> – Type code	113
<i>piconet®</i> – System overview	114
<i>piconet®</i> – General technical informationen	115
<i>piconet®</i> – Overview module types and functions	116

<b>piconet® – Special accessories</b>	<b>Page</b>
Configuration software I/O-ASSISTANT, fibre-optic cable measuring device, fibre-optic cables, fibre-optic connectors, grinding gauge, fibre-optic cable assembly kit, IP-Link bridge, power junctions, compensation connector for thermoelements, earthing clip, DIN rail, mounting plates, drilling templates	120

<b>piconet® – Coupling modules</b>	<b>Page</b>
PROFIBUS-DP	132
DeviceNet™	134
CANopen	136
INTERBUS	138
Modbus TCP	140
EtherNet/IP	142
PROFINET	144

<b>piconet® – Extension modules</b>	<b>Page</b>
Digital input/output modules	148
Analogue input/output modules	172
Technology modules	184
FESTO valve terminals	198

<b>piconet® – Stand-alone modules for PROFIBUS-DP</b>	<b>Page</b>
Digital input/output modules	202
Analogue input/output modules	222
Technology modules	234

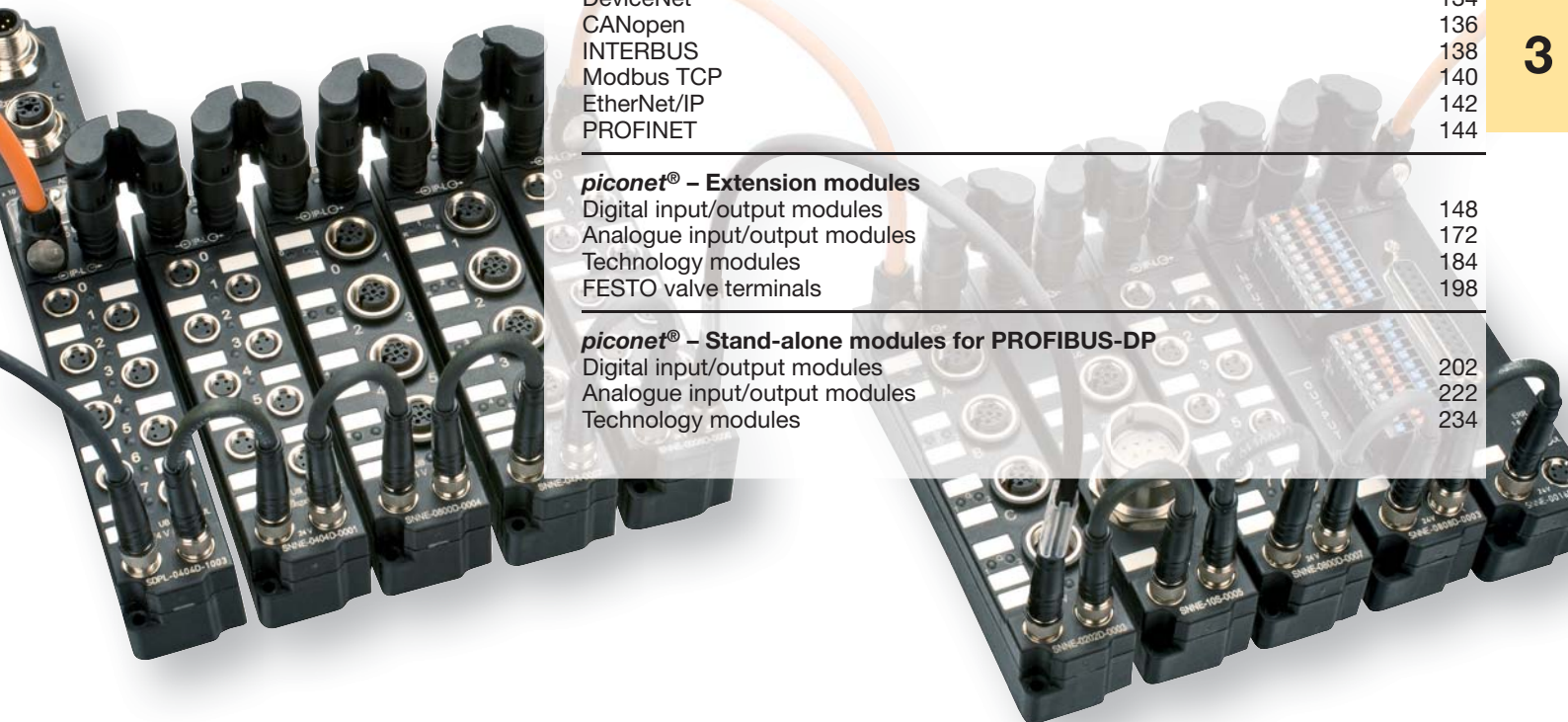

# The *piconet*<sup>®</sup> I/O system – in miniature housings for highest industrial requirements

## *piconet*<sup>®</sup> – Coupling modules

- As interface to the higher level control system
- Gateway between PROFIBUS-DP, CANopen, DeviceNet™, INTERBUS, EtherNet/IP, Modbus TCP, PROFINET and fiber-optic cable based Sub-Bus „IP-Link“
- Coupling modules connect the higher level open fieldbus and the economical extension modules.
- Fiber-optic subnet (IP-Link) for connection of up to 120 extension modules per coupling module
- High-speed transmission, 1000 I/Os in approx. 1 ms via prefabricated and interference-free fiber-optic cables.
- Fiber-optic cable length up to 15 m



Bus addressing switch and service interface to I/O-ASSISTANT software

Bus LEDs

Module/ IP-Link LEDs

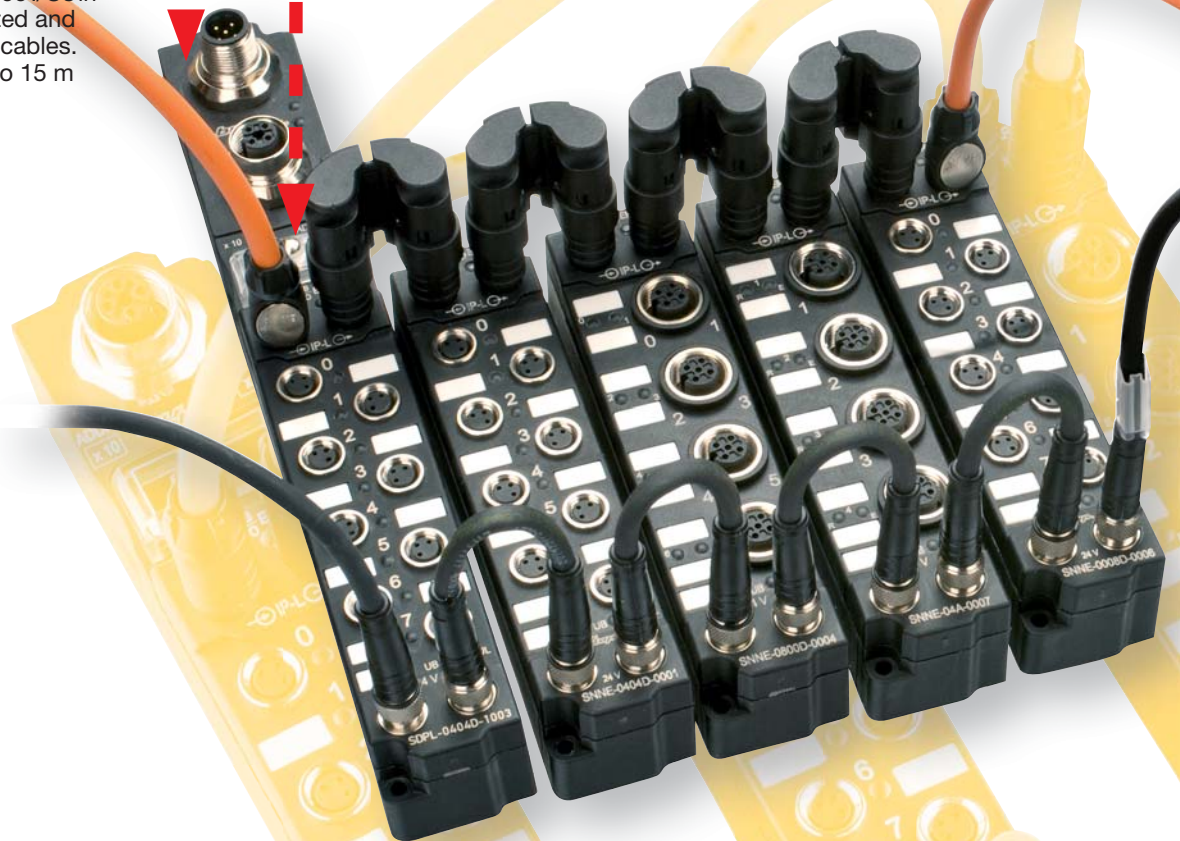

## Compact and robust housing

- Only 26.5 mm high, 30 mm wide and 210, 175 or 126 mm long
- Fully encapsulated IP67 housing
- Suited for direct use on the machine
- Ideally suited for special or serial machine engineering as well as for various field applications

## *piconet*<sup>®</sup>-Stand-alone module

- Stand-alone modules connect the integrated I/Os directly with the open fieldbus, e.g. PROFIBUS-DP, CANopen, DeviceNet™, INTERBUS, Modbus TCP, EtherNet/IP and PROFINET

## A secure connection

- Prefabricated bus, fiber optic, power and I/O cables
- Field-wireable connectors
- Additional networking components such as T-pieces, terminating resistors etc.



**piconet® - Extension modules**

- Flexible and tested I/O connection technology in M8 x 1, M12 x 1 and M23 x 1
- Extension modules independent of the higher level fieldbus system

**piconet® - Bridges for fibre optics and power cables**

- Compact mounting
- Reduced space requirements
- Easy installation
- IP67

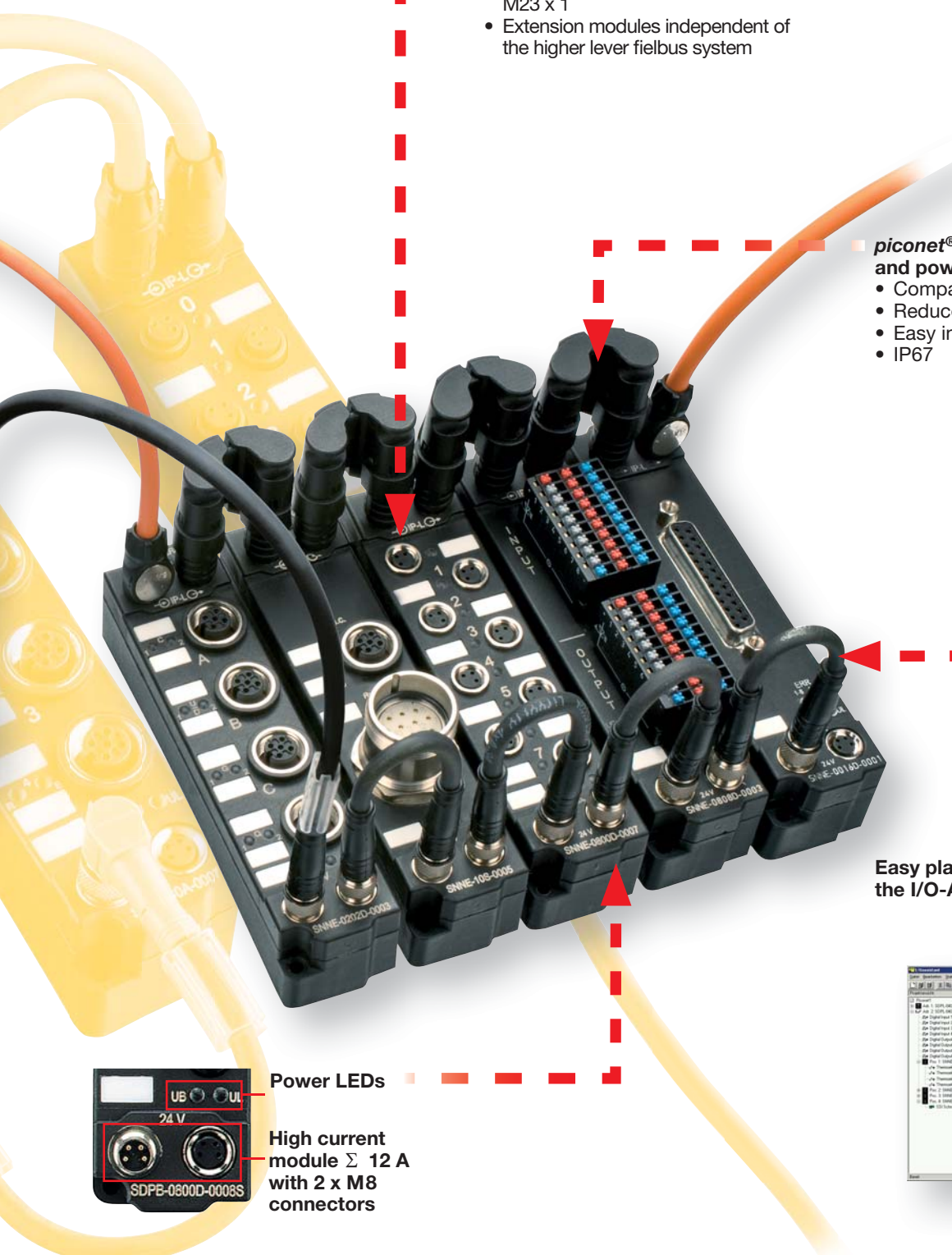

Easy planning and configuration with the I/O-ASSISTANT

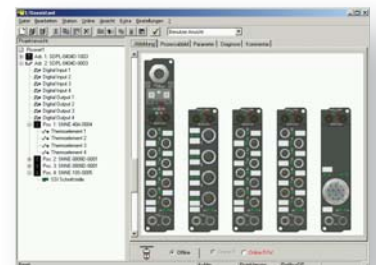

Power LEDs

High current module  $\Sigma$  12 A with 2 x M8 connectors



Modbus TCP

EtherNet/IP™

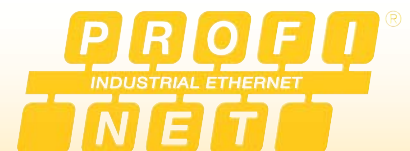

Certified! No.099

# I/O-ASSISTANT

## Easy planning and configuration with the I/O-ASSISTANT

Configuration software for

- Project planning
- Configuration
- Parameterisation

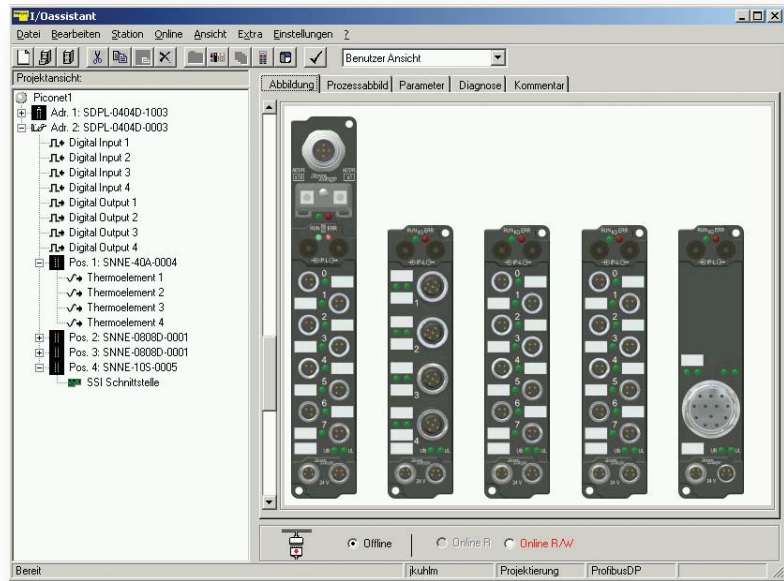

### Description

The configuration software I/O-ASSISTANT supports you in planning and implementation of an I/O system. Whether in the online or offline mode, the I/O-ASSISTANT simplifies module configuration and parameterisation.

The software is also extremely helpful in system set-up and testing.

### Functions

- Convenient software tool
- Selection of the required modules
- Offline planning and configuration of *piconet*<sup>®</sup> modules
- Parameterisation, configuration and set-up of individual modules
- Reading and setting of process data
- Set-up aid for checking the cabling and sensors without a PLC
- Realistic presentation of the configured *piconet*<sup>®</sup> components
- Automatic documentation of configured *piconet*<sup>®</sup> systems

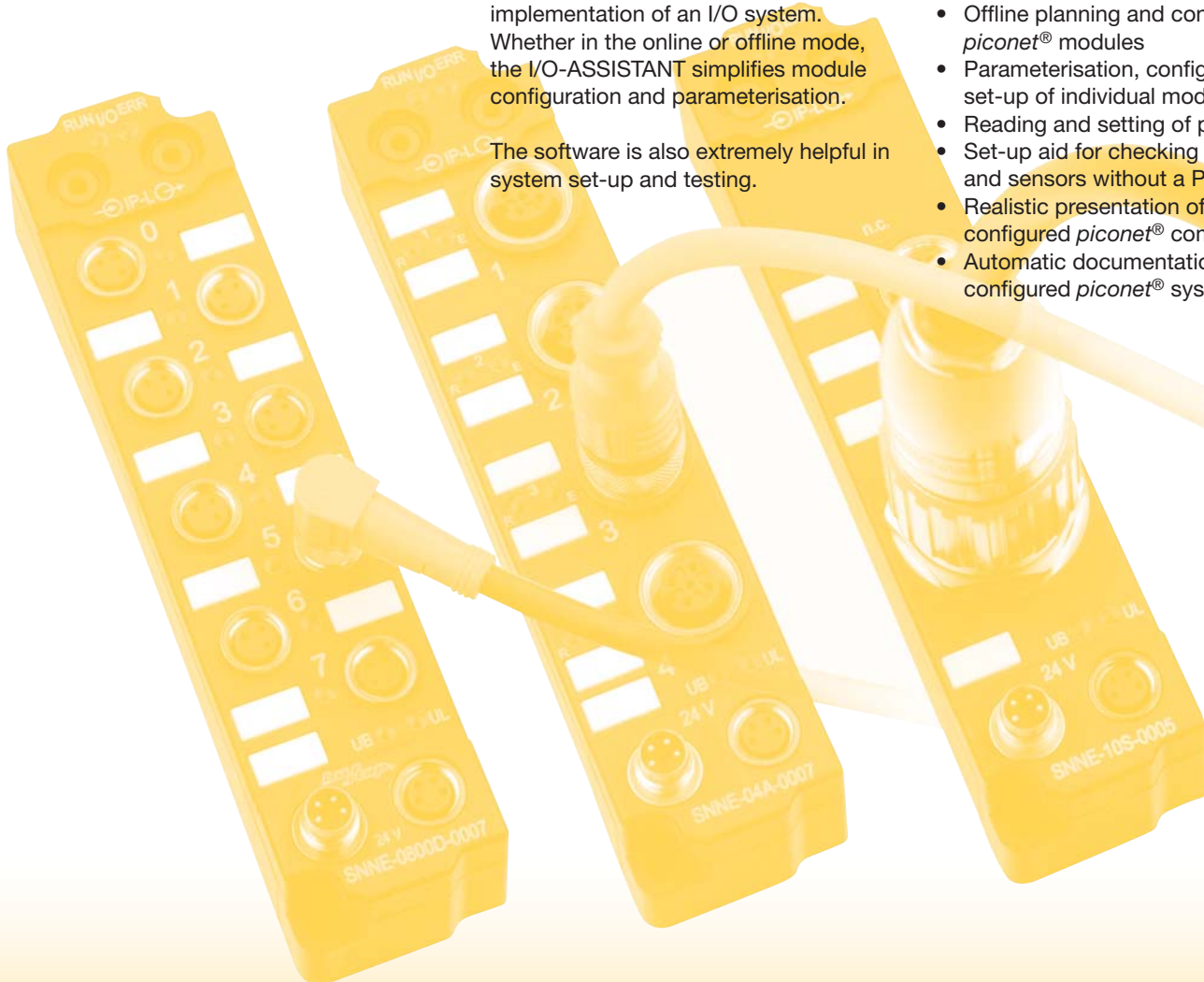



**SDPL - 0404D - 0003**

### Housing style

(S) Small housing style

### Connection fieldbus system

(DP) PROFIBUS-DP  
(DN) DeviceNet  
(CO) CANopen  
(IB) INTERBUS  
(EN) Modbus TCP  
(IP) EtherNet/IP  
(PN) PROFINET  
(NN) IP-Link (Extension modules)

### Module type

(B) Stand-alone module (block module)  
(E) Extension module  
(L) Coupling module (link module)

### Number of channels

(0800) 8-channel input module  
(0008) 8-channel output module  
(0404) 8-channel combined module  
(4 inputs and 4 outputs)  
(0808) 16-channel combined module  
(8 inputs and 8 outputs)  
each 1 input and 1 output per connector)  
(40) 4-channel input module  
(04) 4-channel output module  
(0002) 2-channel pulse width modulation  
(0202) 2-channel up/down counter  
(10) 1-channel interface module

### Signal type

(A) Analogue  
(D) Digital  
(S) Interface module

### Function (0800D)

(2) Filter 0.2 ms 4 x M12  
(4) Filter 3.0 ms 4 x M12  
(7) Filter 3.0 ms 8 x M8  
(8) Filter 0.2 ms 8 x M8

### Function (40A)

(4) Thermoelement 4 x M12  
(5) Differential inputs  $\pm 10$  V 4 x M12  
(7) Differential inputs 0(4)...20 mA 4 x M12  
(9) Resistance thermometers, PT100 4 x M12

### Function (0008D)

(1) 0.5 A 4 x M12  
(2) 2.0 A ( $I_{\Sigma} = 4$  A) 8 x M8  
(3) 2.0 A ( $I_{\Sigma} = 4$  A) 4 x M12  
(4) 2.0 A ( $I_{\Sigma} = 12$  A) 8 x M8  
(5) 2.0 A ( $I_{\Sigma} = 12$  A) 4 x M12  
(6) 0.5 A 8 x M8

### Function (0016D)

(1) 0.5 A ( $I_{\Sigma} = 4$  A) 1 x SUB-D  
(2) 0.5 A ( $I_{\Sigma} = 4$  A), autoreset 1 x SUB-D

### Function (04A)

(7)  $\pm 10$  V 4 x M12  
(9) 0...20 mA 4 x M12

### Function (0002D)

(2) Pulse width modulation, 2,5 A 2 x M12

### Function (0404D)

(1) Filter 0.2 ms, 0.5 A 8 x M8  
(2) Filter 0.2 ms, 0.5 A 4 x M12  
(3) Filter 3.0 ms, 0.5 A 8 x M8  
(4) Filter 3.0 ms, 0.5 A 4 x M12  
(5) Filter 0.2 ms, 2.0 A ( $I_{\Sigma} = 4$  A) 8 x M8  
(6) Filter 0.2 ms, 2.0 A ( $I_{\Sigma} = 4$  A) 4 x M12  
(7) Filter 3.0 ms, 2.0 A ( $I_{\Sigma} = 4$  A) 8 x M8  
(8) Filter 3.0 ms, 2.0 A ( $I_{\Sigma} = 4$  A) 4 x M12

### Function (0808D)

(1) Filter 3.0 ms, 0.5 A ( $I_{\Sigma} = 4$  A) 4 x M12  
(3) Filter 3.0 ms, 0.5 A ( $I_{\Sigma} = 4$  A) IP20 terminals

### Function (0202D)

(3) Channel up/down counter, 100 kHz 4 x M12

### Function (10S)

(1) Incremental encoder 1 x M12, 1 x M23  
(2) Serial interface RS232 1 x M12  
(3) Serial interface 0...20 mA (TTY) 1 x M12  
(4) Serial interface RS422/RS485 1 x M12  
(5) SSI encoder 1 x M23

not used

### Number of bus connections

(0) 1 (external tee piece needed)  
(1) 2 (integrated tee)



### Note:

The type code is for model purposes only and is to explain existing type codes. All possible constallations are thus not also available products!

# **piconet® – Compact I/O system in IP67 – Overview**

*piconet*®, the miniature IP67 product family within the TURCK fieldbus programme, featuring extremely compact housings and a fine modular structure, is the ideal solution for serial and special machine engineering and many other field applications. The product line includes:

- *piconet*® coupling modules  
The coupling modules function as the gateway between the open fieldbus and the fibre-optic based *piconet*® sub-bus „IP-Link“.
- *piconet*® extension modules  
The various extension modules are combined to form a modular network via the fibre-optic based IP-Link .
- *piconet*® stand-alone modules  
Stand-alone-modules connect the integrated inputs/outputs directly to the open fieldbus.

Based on the IP-Link, a modular network can be constructed, with which up to 120 extension modules can be operated via a single coupling module. The coupling module collects the I/O data of the connected extension modules via the interference-immune and fast IP-Link network with a transmission speed of 2 Mbps.

The transmission time for 1,000 I/Os is approx 1 ms – if less data are transferred the transmission speed is even higher. The maximum fibre-optic cable length is 15 m.

The product line comprises of extension and stand-alone modules for the entire spectrum of I/O signals – ranging from standardised digital industrial signals to analogue inputs and outputs. The family is complemented by a choice of technology modules, such as a pulse width modulator, an up/down counter, an

incremental encoder as well as various serial interfaces.

*piconet*® can be connected to all major industrial fieldbus systems (e.g. PROFIBUS-DP, DeviceNet™, CANopen, INTERBUS, Modbus TCP, EtherNet/IP and PROFINET).

The robust IP67 housing is extremely compact, fully encapsulated and equipped throughout with metal connectors. As a result, the modules are perfectly suited for application in harsh industrial environments as well as in space-critical applications in special and serial machine engineering.

The operating and load supply are fed separately to all *piconet*® modules. A status LED is assigned to each channel to provide signal status indications.

## ***piconet*® – modular network with direct connection to the higher level fieldbus**

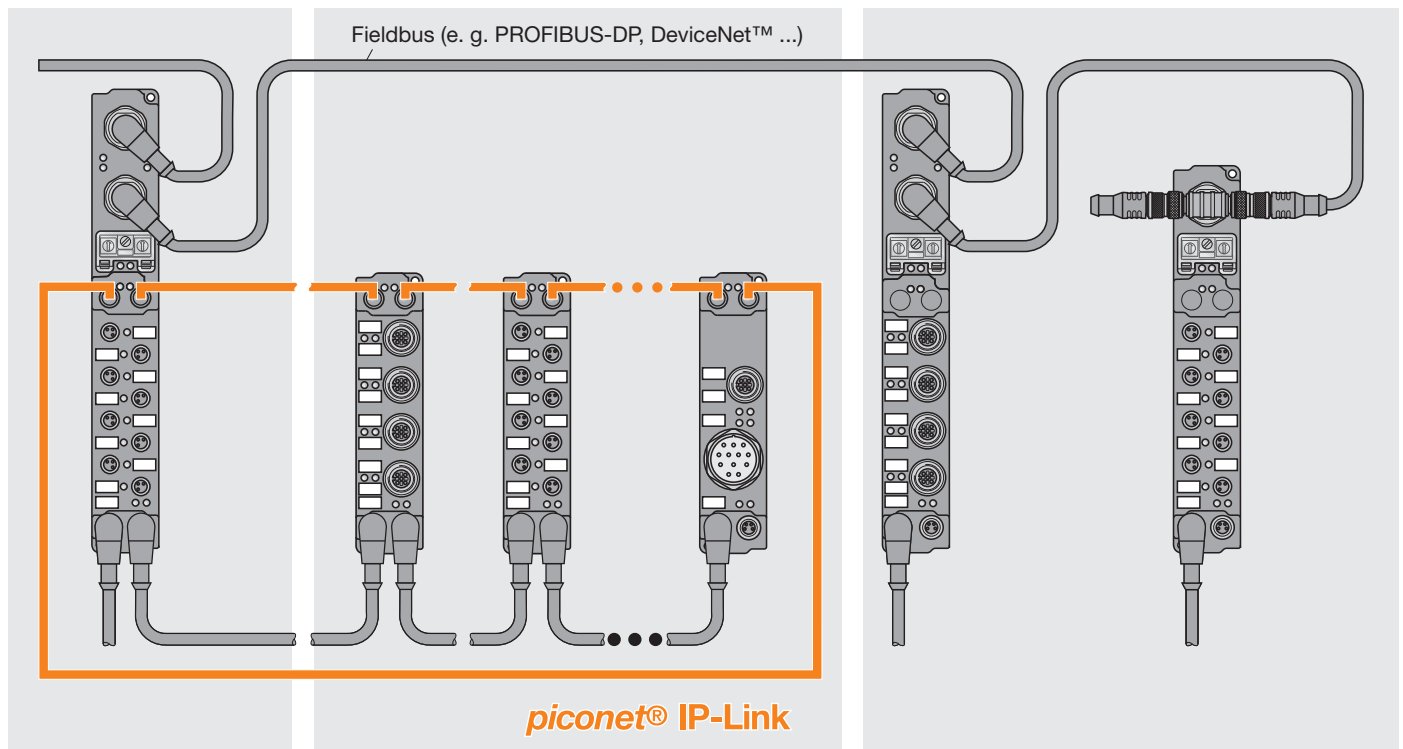

**Coupling module (Gateway)**

**Extension modules**

**Stand-alone modules**

The figure shows a PROFIBUS-DP application.

## **piconet® – General technical information**

A detailed technical system description as well as application guidelines for *piconet®* fieldbus components are contained in the *piconet®* – User Manual.



### **Earthing/Shielding concept**

The shield is capacitively coupled with the base of the *piconet®* modules. In order to eliminate interferences effectively via the shield, the surface on which the module is mounted must provide a low impedance or low-resistance connection to the ground ( e.g. the ground reference plane, the machine's ground). Optionally, the shield of the bus cable can be directly earthed via the *piconet®* earthing clip EL-0002.

### **Data mapping**

#### **Compact mapping**

In the compact data mapping mode, purely process/user data are mapped. Data of bit-oriented modules are mapped in the compact mode only.

#### **Complex mapping**

In the complex data mapping mode, control and status byte are mapped in addition to process/user data. Data of byte-oriented modules can be mapped either in the compact or complex mode.

**Note:** *piconet®* coupling modules first map the data of the byte-oriented (complex) extension modules to the process image according to their physical order within the IP-Link network. Then the data of the bit-oriented extension modules are added to the process image

### **Data formats**

#### **The Intel format**

In the Intel format, the most significant data byte follows the least significant data byte. The Intel format is colloquially also referred to as the "little Endian".

#### **The Motorola format**

In the Motorola format, the least significant data byte follows the most significant data byte. The Motorola format is colloquially also referred to as the "big Endian".

**Note:** The default data format setting of the various fieldbus types differs. Fieldbus components for DeviceNet™, CANopen and Ethernet are set by default to Intel, while PROFIBUS-DP and INTERBUS components are pre-set to the Motorola format. In the catalogue, the mapping tables (process images) of the extension modules are exclusively shown in the Motorola format.

### **Alignment**

#### **Byte alignment**

In order to ensure that the addressing area always starts at the beginning of a byte, so-called filler bits (unused/idle) are inserted into the process image when the byte alignment option is activated.

#### **Word alignment**

In order to ensure that the addressing area always starts at the beginning of a word, so-called filler bytes (unused/idle) are inserted into the process image when the word alignment option is activated.

### ***piconet®*-User manuals:**

For download on: [www.turck.com](http://www.turck.com) →  
Headquarters → Download

# piconet® – Overview of module types and functions

## piconet® – Configuration options

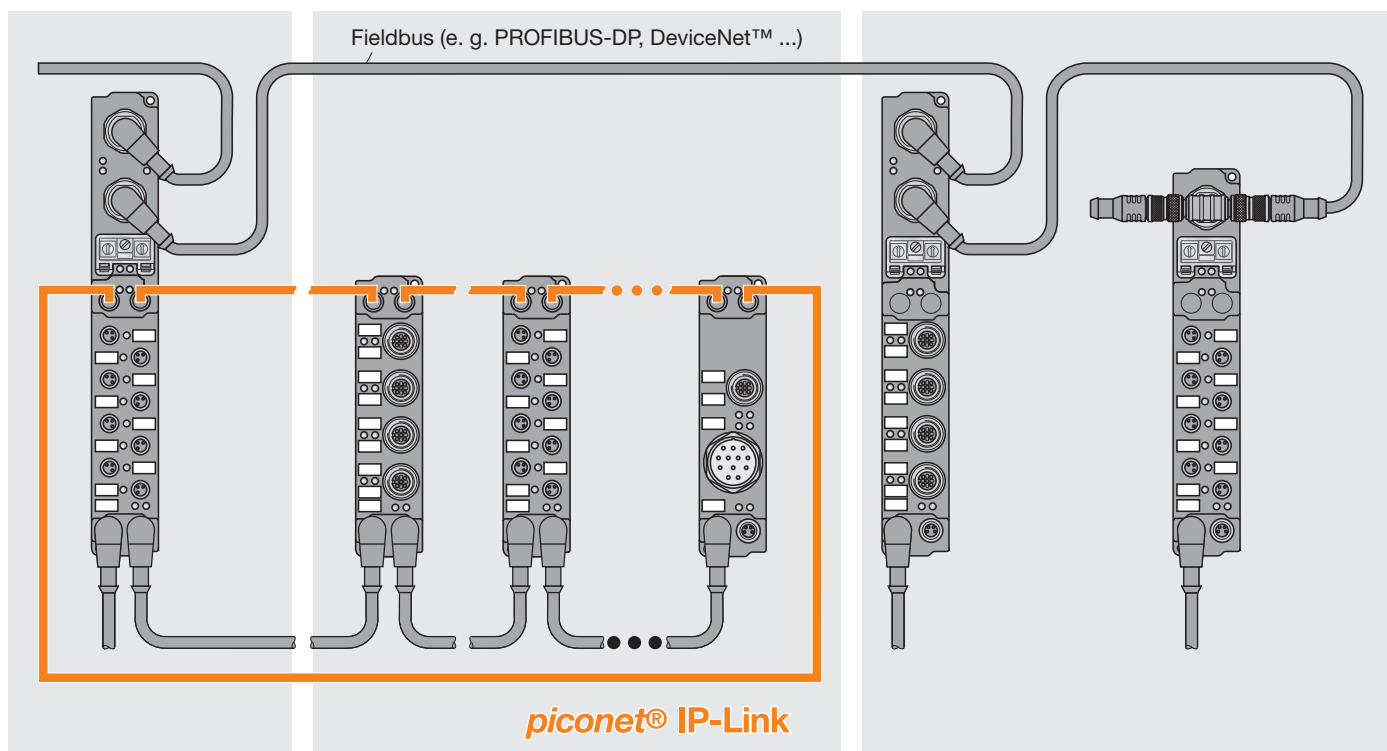

Coupling module (Gateway)

Extension modules

Stand-alone modules

## Coupling modules (Gateway)

Fieldbus type	Module type	Digital modules – Description	I/O connection	Bus connect.	Ident-No.	Page
PROFIBUS-DP	SDPL-0404D-0003	4 inputs and 4 outputs, 0.5 A, filter 3.0 ms	8 x M8	1 x M12	6824173	132
PROFIBUS-DP	SDPL-0404D-0004	4 inputs and 4 outputs, 0.5 A, filter 3.0 ms	4 x M12	1 x M12	6824175	132
PROFIBUS-DP	SDPL-0404D-1003	4 inputs and 4 outputs, 0.5 A, filter 3.0 ms	8 x M8	2 x M12	6824450	132
PROFIBUS-DP	SDPL-0404D-1004	4 inputs and 4 outputs, 0.5 A, filter 3.0 ms	4 x M12	2 x M12	6824451	132
DeviceNet™	SDNL-0404D-0003	4 inputs and 4 outputs, 0.5 A, filter 3.0 ms	8 x M8	1 x M12	6824227	134
DeviceNet™	SDNL-0404D-0004	4 inputs and 4 outputs, 0.5 A, filter 3.0 ms	4 x M12	1 x M12	6824225	134
DeviceNet™	SDNL-0404D-1003	4 inputs and 4 outputs, 0.5 A, filter 3.0 ms	8 x M8	2 x M12	6824457	134
DeviceNet™	SDNL-0404D-1004	4 inputs and 4 outputs, 0.5 A, filter 3.0 ms	4 x M12	2 x M12	6824453	134
CANopen	SCOL-0404D-0003	4 inputs and 4 outputs, 0.5 A, filter 3.0 ms	8 x M8	1 x M12	6824221	136
CANopen	SCOL-0404D-0004	4 inputs and 4 outputs, 0.5 A, filter 3.0 ms	4 x M12	1 x M12	6824219	136
CANopen	SCOL-0404D-1003	4 inputs and 4 outputs, 0.5 A, filter 3.0 ms	8 x M8	2 x M12	6824454	136
CANopen	SCOL-0404D-1004	4 inputs and 4 outputs, 0.5 A, filter 3.0 ms	4 x M12	2 x M12	6824456	136
INTERBUS	SIBL-0404D-0003	4 inputs and 4 outputs, 0.5 A, filter 3.0 ms	8 x M8	1 x M12	6824224	138
INTERBUS	SIBL-0404D-0004	4 inputs and 4 outputs, 0.5 A, filter 3.0 ms	4 x M12	1 x M12	6824222	138
Modbus TCP	SENL-0404D-0003	4 inputs and 4 outputs, 0.5 A, filter 3.0 ms	8 x M8	1 x RJ45	6824242	140
Modbus TCP	SENL-0404D-0004	4 inputs and 4 outputs, 0.5 A, filter 3.0 ms	4 x M12	1 x RJ45	6824240	140
Modbus TCP	SENL-0404D-0001	4 inputs and 4 outputs, 0.5 A, filter 3.0 ms	8 x M8	1 x M12	6824480	140
Modbus TCP	SENL-0404D-0002	4 inputs and 4 outputs, 0.5 A, filter 3.0 ms	4 x M12	1 x M12	6824481	140
EtherNet/IP	SIPL-0404D-0003	4 inputs and 4 outputs, 0.5 A, filter 3.0 ms	8 x M8	1 x M12	6824472	142
EtherNet/IP	SIPL-0404D-0004	4 inputs and 4 outputs, 0.5 A, filter 3.0 ms	4 x M12	1 x M12	6824471	142
PROFINET	SPNL-0404D-0003	4 inputs and 4 outputs, 0.5 A, filter 3.0 ms	8 x M8	1 x M12	6824478	144
PROFINET	SPNL-0404D-0004	4 inputs and 4 outputs, 0.5 A, filter 3.0 ms	4 x M12	1 x M12	6824477	144

## Extension modules for IP-Link

Module type	Digital modules – Description	I/O connection	Ident-No.	Page
SNNE-0800D-0007	8 inputs, 24 VDC, filter 3,0 ms	8 x M8	6824204	148
SNNE-0800D-0004	8 inputs, 24 VDC, filter 3,0 ms	4 x M12	6824203	148
SNNE-0800D-0008	8 inputs, 24 VDC, filter 0.2 ms	8 x M8	6824206	150
SNNE-0800D-0002	8 inputs, 24 VDC, filter 3,0 ms	4 x M12	6824202	150
SNNE-0008D-0006	8 outputs, 24 VDC, 0.5 A	8 x M8	6824185	152
SNNE-0008D-0001	8 outputs, 24 VDC, 0.5 A	4 x M12	6824178	152
SNNE-0008D-0002	8 outputs, 24 VDC, 2 A ( $I_{\Sigma} = 4 A$ )	8 x M8	6824179	154
SNNE-0008D-0003	8 outputs, 24 VDC, 2 A ( $I_{\Sigma} = 4 A$ )	4 x M12	6824181	154
SNNE-0008D-0004	8 outputs, 24 VDC, 2 A ( $I_{\Sigma} = 12 A$ )	8 x M8	6824182	156
SNNE-0008D-0005	8 outputs, 24 VDC, 2 A ( $I_{\Sigma} = 12 A$ )	4 x M12	6824184	156
SNNE-0016D-0001	16 outputs, 24 VDC, 0,5 A ( $I_{\Sigma} = 4 A$ )	SUB-D	6824468	158
SNNE-0016D-0002	16 outputs, 24 VDC, 0,5 A ( $I_{\Sigma} = 4 A$ ), autoreset	SUB-D	6824476	158
SNNE-0404D-0003	4 inputs and 4 outputs,, 24 VDC, 0,5 A, Filter 3.0 ms	8 x M8	6824191	160
SNNE-0404D-0004	4 inputs and 4 outputs,, 24 VDC, 0,5 A, Filter 3.0 ms	4 x M12	6824193	160
SNNE-0404D-0001	4 inputs and 4 outputs,, 24 VDC, 0,5 A, Filter 0.2 ms	8 x M8	6824188	162
SNNE-0404D-0002	4 inputs and 4 outputs,, 24 VDC, 0,5 A, Filter 0.2 ms	4 x M12	6824190	162
SNNE-0404D-0007	4 inputs and 4 outputs,, 24 VDC, 2 A ( $I_{\Sigma} = 4 A$ ), Filter 3.0 ms	8 x M8	6824197	164
SNNE-0404D-0008	4 inputs and 4 outputs,, 24 VDC, 2 A ( $I_{\Sigma} = 4 A$ ), Filter 3.0 ms	4 x M12	6824199	164
SNNE-0404D-0005	4 inputs and 4 outputs,, 24 VDC, 2 A ( $I_{\Sigma} = 4 A$ ), Filter 0.2 ms	8 x M8	6824194	166
SNNE-0404D-0006	4 inputs and 4 outputs,, 24 VDC, 2 A ( $I_{\Sigma} = 4 A$ ), Filter 0.2 ms	4 x M12	6824196	166
SNNE-0808D-0001	8 inputs and 8 outputs, 24 VDC, 0,5 A, Filter 3.0 ms	8 x M8	6824208	168
SNNE-0808D-0003	8 inputs and 8 outputs, 24 VDC, 0,5 A, Filter 3.0 ms	IP20 terminals	6824473	170

Module type	Analogue modules – Description	I/O connection	Ident-No.	Page
SNNE-40A-0005	4 analogue differential inputs, $\pm 10 V$ , 16 bit	4 x M12	6824216	172
SNNE-40A-0007	4 analogue differential inputs, 0/4...20 mA, 16 bit	4 x M12	6824217	174
SNNE-40A-0009	4 analogue inputs for Pt100 (RTD)	4 x M12	6824176	176
SNNE-40A-0004	4 analogue inputs for thermoelements	4 x M12	6824215	178
SNNE-04A-0007	4 analogue outputs, $\pm 10 V$ , 16 Bit	4 x M12	6824200	180
SNNE-04A-0009	4 analogue outputs, 0...20 mA, 16 Bit	4 x M12	6824201	182

Module type	Technology modules – Description	I/O connection	Ident-No.	Page
SNNE-0002D-0002	2-channel pulse width modulation, 24 VDC, 2.5 A	2 x M12	6824177	184
SNNE-0202D-0003	2-channel up/down counter, 24 VDC, 100 kHz	2 x M12	6824187	186
SNNE-10S-0001	1-channel incremental encoder interface	1 x M12, 1 x M23	6824210	188
SNNE-10S-0002	1-channel serial interface RS232	1 x M12	6824211	190
SNNE-10S-0003	1-channel serial interface 0...20 mA (TTY)	1 x M12	6824212	192
SNNE-10S-0004	1-channel serial interface RS422/485	1 x M12	6824213	194
SNNE-10S-0005	1-channel SSI encoder interface	1 x M23	6824214	196

Module type	FESTO valve terminal – Description	Ident-No.	Page
CPV10-VI-IP8-8	8 valve discs with max. 16 valve coils, size per valve disc 10 mm	1)	198
CPV14-VI-IP8-8	8 valve discs with max. 16 valve coils, size per valve disc 14 mm	1)	198

1) the CPV valve terminal is exclusively sold by the company FESTO AG & Co

# piconet® – Overview of module types and functions

## Stand-alone-Module für PROFIBUS-DP

Module type	Digital modules – Description	I/O connection	Bus connect.	Ident-No.	Page
SDPB-0800D-0007	8 inputs, 24 VDC, filter 3.0 ms	8 x M8	1 x M12	6824058	202
SDPB-0800D-0004	8 inputs, 24 VDC, filter 3.0 ms	4 x M12	1 x M12	6824071	202
SDPB-0800D-1007	8 inputs, 24 VDC, filter 3.0 ms	8 x M8	2 x M12	6824409	202
SDPB-0800D-1004	8 inputs, 24 VDC, filter 3.0 ms	4 x M12	2 x M12	6824410	202
SDPB-0800D-0008	8 inputs, 24 VDC, filter 0.2 ms	8 x M8	1 x M12	6824048	204
SDPB-0800D-0002	8 inputs, 24 VDC, filter 0.2 ms	4 x M12	1 x M12	6824070	204
SDPB-0800D-1008	8 inputs, 24 VDC, filter 0.2 ms	8 x M8	2 x M12	6824407	204
SDPB-0800D-1002	8 inputs, 24 VDC, filter 0.2 ms	4 x M12	2 x M12	6824412	204
SDPB-0008D-0006	8 outputs, 24 VDC, 0.5 A	8 x M8	1 x M12	6824057	206
SDPB-0008D-0001	8 outputs, 24 VDC, 0.5 A	4 x M12	1 x M12	6824061	206
SDPB-0008D-1006	8 outputs, 24 VDC, 0.5 A	8 x M8	2 x M12	6824415	206
SDPB-0008D-1001	8 outputs, 24 VDC, 0.5 A	4 x M12	2 x M12	6824416	206
SDPB-0008D-0002	8 outputs, 24 VDC, 2 A ( $I_{\Sigma} = 4$ A)	8 x M8	1 x M12	6824056	208
SDPB-0008D-0003	8 outputs, 24 VDC, 2 A ( $I_{\Sigma} = 4$ A)	4 x M12	1 x M12	6824063	208
SDPB-0008D-1002	8 outputs, 24 VDC, 2 A ( $I_{\Sigma} = 4$ A)	8 x M8	2 x M12	6824405	208
SDPB-0008D-1003	8 outputs, 24 VDC, 2 A ( $I_{\Sigma} = 4$ A)	4 x M12	2 x M12	6824418	208
SDPB-0008D-0004	8 outputs, 24 VDC, 2 A ( $I_{\Sigma} = 12$ A)	8 x M8	1 x M12	6824064	210
SDPB-0008D-0005	8 outputs, 24 VDC, 2 A ( $I_{\Sigma} = 12$ A)	4 x M12	1 x M12	6824066	210
SDPB-0008D-1004	8 outputs, 24 VDC, 2 A ( $I_{\Sigma} = 12$ A)	8 x M8	2 x M12	6824420	210
SDPB-0008D-1005	8 outputs, 24 VDC, 2 A ( $I_{\Sigma} = 12$ A)	4 x M12	2 x M12	6824421	210
SDPB-0404D-0003	4 inputs and 4 outputs, 24 VDC, 0.5 A, filter 3.0 ms	8 x M8	1 x M12	6824114	212
SDPB-0404D-0004	4 inputs and 4 outputs, 24 VDC, 0.5 A, filter 3.0 ms	4 x M12	1 x M12	6824115	212
SDPB-0404D-1003	4 inputs and 4 outputs, 24 VDC, 0.5 A, filter 3.0 ms	8 x M8	2 x M12	6824423	212
SDPB-0404D-1004	4 inputs and 4 outputs, 24 VDC, 0.5 A, filter 3.0 ms	4 x M12	2 x M12	6824424	212
SDPB-0404D-0001	4 inputs and 4 outputs, 24 VDC, 0.5 A, filter 0.2 ms	8 x M8	1 x M12	6824049	214
SDPB-0404D-0002	4 inputs and 4 outputs, 24 VDC, 0.5 A, filter 0.2 ms	4 x M12	1 x M12	6824113	214
SDPB-0404D-1001	4 inputs and 4 outputs, 24 VDC, 0.5 A, filter 0.2 ms	8 x M8	2 x M12	6824426	214
SDPB-0404D-1002	4 inputs and 4 outputs, 24 VDC, 0.5 A, filter 0.2 ms	4 x M12	2 x M12	6824427	214
SDPB-0404D-0007	4 inputs and 4 outputs, 24 VDC, 2 A ( $I_{\Sigma} = 4$ A), Filter 3.0 ms	8 x M8	1 x M12	6824119	216
SDPB-0404D-0008	4 inputs and 4 outputs, 24 VDC, 2 A ( $I_{\Sigma} = 4$ A), Filter 3.0 ms	4 x M12	1 x M12	6824111	216
SDPB-0404D-1007	4 inputs and 4 outputs, 24 VDC, 2 A ( $I_{\Sigma} = 4$ A), Filter 3.0 ms	8 x M8	2 x M12	6824429	216
SDPB-0404D-1008	4 inputs and 4 outputs, 24 VDC, 2 A ( $I_{\Sigma} = 4$ A), Filter 3.0 ms	4 x M12	2 x M12	6824430	216
SDPB-0404D-0005	4 inputs and 4 outputs, 24 VDC, 2 A ( $I_{\Sigma} = 4$ A), Filter 0.2 ms	8 x M8	1 x M12	6824116	218
SDPB-0404D-0006	4 inputs and 4 outputs, 24 VDC, 2 A ( $I_{\Sigma} = 4$ A), Filter 0.2 ms	4 x M12	1 x M12	6824118	218
SDPB-0404D-1005	4 inputs and 4 outputs, 24 VDC, 2 A ( $I_{\Sigma} = 4$ A), Filter 0.2 ms	8 x M8	2 x M12	6824432	218
SDPB-0404D-1006	4 inputs and 4 outputs, 24 VDC, 2 A ( $I_{\Sigma} = 4$ A), Filter 0.2 ms	4 x M12	2 x M12	6824433	218
SDPB-0808D-0001	8 inputs and 8 outputs, 24 VDC, 0.5 A, Filter 3.0 ms	8 x M8	1 x M12	6824167	220
SDPB-0808D-1001	8 inputs and 8 outputs, 24 VDC, 0.5 A, Filter 3.0 ms	8 x M8	2 x M12	6824435	220



In addition to the stand-alone modules for PROFIBUS-DP there are also Stand-alone modules for DeviceNet™ and CANopen available. More information on availability of various signal types can be obtained directly from TURCK.

Module type	Analogue modules – Description	I/O connection	Bus connect.	Ident-No.	Page
SDPB-40A-0005	4 analogue differential inputs, ±10 V, 16 bit	4 x M12	1 x M12	6824051	222
SDPB-40A-1005	4 analogue differential inputs, ±10 V, 16 bit	4 x M12	2 x M12	6824438	222
SDPB-40A-0007	4 analogue differential inputs, 0/4...20 mA	4 x M12	1 x M12	6824052	224
SDPB-40A-1007	4 analogue differential inputs, 0/4...20 mA	4 x M12	2 x M12	6824439	224
SDPB-40A-0009	4 analogue inputs for Pt100 (RTD)	4 x M12	1 x M12	6824040	226
SDPB-40A-1009	4 analogue inputs for Pt100 (RTD)	4 x M12	2 x M12	6824440	226
SDPB-40A-0004	4 analogue inputs for thermoelements	4 x M12	1 x M12	6824050	228
SDPB-40A-1004	4 analogue inputs for thermoelements	4 x M12	2 x M12	6824441	228
SDPB-04A-0007	4 analogue outputs, ±10 V, 16 bit	4 x M12	1 x M12	6824069	230
SDPB-04A-1007	4 analogue outputs, ±10 V, 16 bit	4 x M12	2 x M12	6824443	230
SDPB-04A-0009	4 analogue outputs, 0...20 mA, 16 bit	4 x M12	1 x M12	6824059	232
SDPB-04A-1009	4 analogue outputs, 0...20 mA, 16 bit	4 x M12	2 x M12	6824442	232

Module type	Technology modules – Description	I/O connection	Bus connect.	Ident-No.	Page
SDPB-0002D-0002	2-channel pulse width modulation, 24 VDC, 2.5 A	2 x M12	1 x M12	6824060	234
SDPB-0002D-1002	2-channel pulse width modulation, 24 VDC, 2.5 A	2 x M12	2 x M12	6824437	234
SDPB-0202D-0003	2-channel up/down counter, 24 VDC, 100 kHz	2 x M12	1 x M12	6824068	236
SDPB-0202D-1003	2-channel up/down counter, 24 VDC, 100 kHz	2 x M12	2 x M12	6824413	236
SDPB-10S-0001	1-channel incremental encoder interface	1 x M12, 1 x M23	1 x M12	6824074	238
SDPB-10S-1001	1-channel incremental encoder interface	1 x M12, 1 x M23	2 x M12	6824445	238
SDPB-10S-0002	1-channel serial interface RS232	2 x M12	1 x M12	6824075	240
SDPB-10S-1002	1-channel serial interface RS232	2 x M12	2 x M12	6824446	240
SDPB-10S-0003	1-channel serial interface 0...20 mA (TTY)	2 x M12	1 x M12	6824076	242
SDPB-10S-1003	1-channel serial interface 0...20 mA (TTY)	2 x M12	2 x M12	6824447	242
SDPB-10S-0004	1-channel serial interface RS422/485	2 x M12	1 x M12	6824077	244
SDPB-10S-1004	1-channel serial interface RS422/485	2 x M12	2 x M12	6824448	244
SDPB-10S-0005	1-channel SSI encoder interface	1 x M23	1 x M12	6824078	246
SDPB-10S-1005	1-channel SSI encoder interface	1 x M23	2 x M12	6824444	246

# **piconet® – Special accessories**

## **piconet® – Special accessories**

**Page**

Fiber-optic cable	122
Field-wireable fibre optic connector	123
Grinding gauge	123
Fibre-optic cable assembly kit	123
Fibre-optic measuring device	124
Fibre-optic bridge	124
Power bridge	124
DIN rail	124
IP20 terminal blocks	125
SUB-D connector IP67	125
<i>piconet®</i> sets	125
<i>piconet®</i> planning and configuration freeware I/O-ASSISTANT and adapter cable	125
<i>piconet®</i> thermoelement compensation connector	126
Earthing clip for <i>piconet®</i> modules	126
Mounting plate für <i>piconet®</i> housings for mounting on a DIN rail	126
<i>piconet®</i> power junction boxes	127
<i>piconet®</i> drilling templates	128

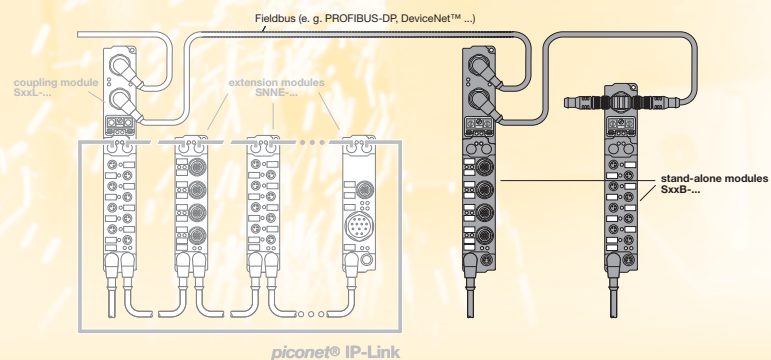
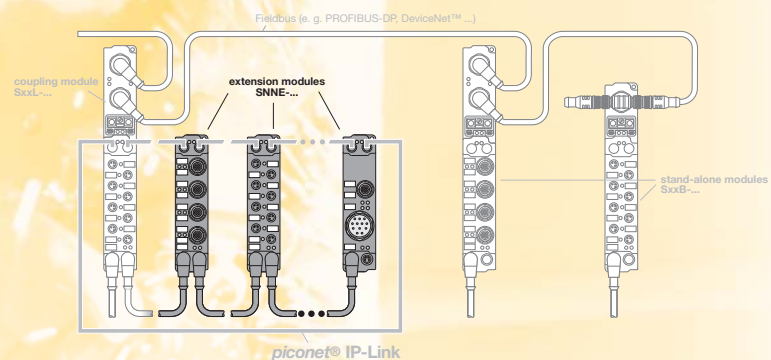
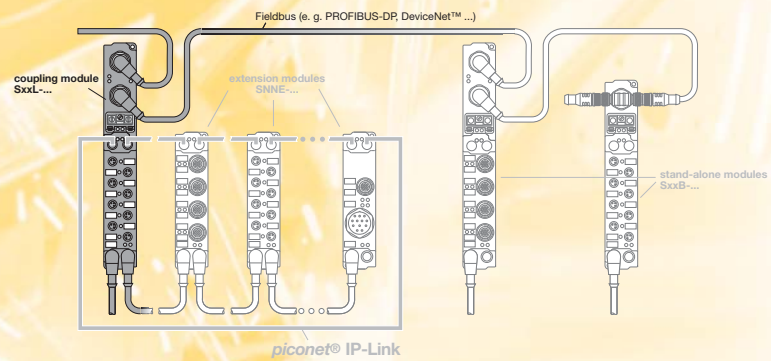





# piconet® – Special accessories

## piconet® – technical data of fibre-optic cables “IP-Link“

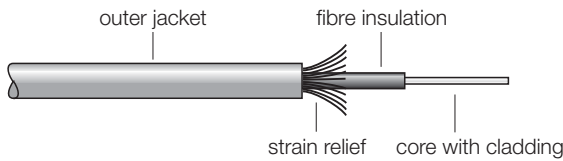

### ⚠ ATTENTION:

For detailed assembly instructions concerning the IP-Link fiber optic cables, please refer to the “piconet® - User manual I/O modules“ i.e. the mounting instructions of the IP-Link connector SFOC-0002-10

<b>Profile</b> Material fibre core Material fibre jacket Material fibre insulation Material strain relief Material outer jacket	step index PMMA, Ø 980 µm PMMA, Ø 1000 µm PE, colour black, Ø 2,2 mm Aramid (Kevlar) PUR, colour orange, Ø 5,5 ± 0,2 mm
<b>Application</b>	for stationary installation in the machine sector, in cable ducts and conduits on cable racks for flexible use in robot applications with slight dynamic strain for use in trailing cables
<b>Transmission characteristics</b> – Attenuation at 650 nm	typ. 170...180 dB/km, max. 200 dB/km
<b>Numerical aperture</b>	0,5
<b>Mechanical features</b> – Bending radius, static – Bending radius, dynamic – Bending radius, trailing chain	min. 50 mm min. 10 × outer diameter min. 10 x outer diameter (approx. 2 million cycles)
<b>Chemical features</b>	very good resistance to oils, fat, acids, alkalis long-term installation in water not admissible
<b>Operating temperature</b> Storage temperature	-20...+ 70 °C -40...+ 70 °C
<b>Flammability</b>	flame-retardent halogen-free to IEC 60754-2A1:1997, no corrosive and toxic gases

## piconet® – premoulded IP-Link fibre-optic cables

Figure	Description	Type	Ident-No.
	fibre-optic cable, 0.2 m, trailing capable	<b>SFOL-0,2M</b>	6603379
	fibre-optic cable, 0.25 m, trailing capable	<b>SFOL-0,25M</b>	6603750
	fibre-optic cable, 0.3 m, trailing capable	<b>SFOL-0,3M</b>	6603382
	fibre-optic cable, 0.5 m, trailing capable	<b>SFOL-0,5M</b>	6603383
	fibre-optic cable, 1 m, trailing capable	<b>SFOL-1M</b>	6603384
	fibre-optic cable, 2 m, trailing capable	<b>SFOL-2M</b>	6603385
	fibre-optic cable, 3 m, trailing capable	<b>SFOL-3M</b>	6611279
	fibre-optic cable, 5 m, trailing capable	<b>SFOL-5M</b>	6603386
	fibre-optic cable, 10 m, trailing capable	<b>SFOL-10M</b>	6611280
	fibre-optic cable, 15 m, trailing capable	<b>SFOL-15M</b>	6611281

**piconet® – IP-Link fibre-optic bulk cable**

Figure	Description	Type	Ident-No.
	Fibre-optic cable, bulk cable, x = length in metres Fiber-optic cable reel, 500 m	<b>SFOF-xM</b> <b>SFOF-500M-ROLLE</b>	6603393 6611086

**piconet® – Field-wireable IP-Link connector**

Figure	Description	Type	Ident-No.
	The new IP-Link connector makes assembling the fiber optic cable considerably easier. PVC grip. The fiber optic cable is locked with a terminal clamp made of die-cast zinc. The cable is strongly fixated by pushing the terminal clamp in the connector. Degree of protection IP67. (10 pcs. per pack)	<b>SFOC-0002-10</b>	6604094

**piconet® – Fibre-optic cable IP-Link – Grinding gauge**

Figure	Description	Type	Ident-No
	The front face of the prefabricated fiber-optic cable is optimally processed with the grinding gauge.	<b>LWL-SL-SFOC-0002</b>	6901180

**piconet® Fibre-optic cable IP-Link – Assembly kit**

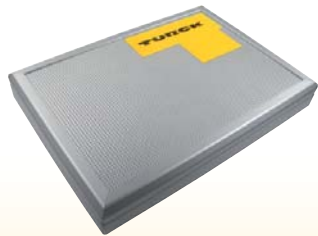
Figure	Description	Type	Ident-No.
	The fiber-optic assembly kit is the ideal tool for all users who want to assemble the fiber-optic cables for the <i>piconet®</i> sub-system IP-Link themselves. Content: 1 cable stripper 1 diagonal cutter 1 grinding gauge for connector type SFOC-0002 1 sand paper, grain size 600 1 mounting guidelines	<b>LWL-KS-SFOC-0002</b>	6901181

# **piconet® – Special accessories**

## **piconet® – Fibre-optic cable IP-Link – Measuring device**

Figure	Description	Type	Ident-No.
	The optical measuring device determines the light intensity and the degree of attenuation produced by the fibre-optic cable IP-Link by using a stabilized light source. The integrated microprocessor enables the measuring of wave lengths of 590 nm which are displayed either as $\mu\text{W}$ or dBm. Zero calibration is automatically started after switching on the device.	<b>LWL-MG</b>	6901182

## **piconet® – Fibre-optic cable IP-Link – Bridge**

Figure	Description	Type	Ident-No.
	The IP-Link bridge provides considerable mounting comfort, especially for compact mounting of the extension modules. The flexible centerpiece of the jumper enables the line up of extension modules at a distance between 0 and 5 mm. If the optional DIN rail SNNE-RAIL500 with M3 drills is used, the time for mounting is further reduced. Degree of protection IP67.	<b>SFOB-0001</b>	6603817



## **piconet® – Power bridge**

Figure	Description	Type	Ident-No.
	The power bridge eases assembly of extension modules, especially for compact mounting of the extension modules. If the optional DIN rail SNNE-RAIL500 with M3 threaded holes is used, the time for mounting is further reduced. Degree of protection IP67. Further information about power cables is provided in the chapter General Accessories.	<b>IPSKP4-0,12-SSP4/S90/S2154</b>	8030976

## **piconet® – DIN rail**

Figure	Description	Type	Ident-No.
	The DIN rail with M3 threaded holes for quick mounting of <i>piconet®</i> extension modules is optional and made of stainless steel (V2A). Up to 15 extension modules can be lined up in a distance of 2 mm. Direct mounting on the machine with M5 screws is possible. 175 x 30 x 500 mm (H x W x D)	<b>SNNE-RAIL500</b>	6824470

**piconet® – IP20 terminal blocks**

Figure	Description	Type	Ident-No.
	Single-row terminal block with 10 terminals for 8 I/O channels, "Push-in" technology for tool free connections, clear display of signal status via LEDs, degree of protection IP20. For usage in combination with piconet® extension module SNNE-0808D-0003.	<b>SNNE-BL I/O 3,5-10/LED-SET</b>	6824475
	3-row terminal block with 30 terminals for 8 I/O channels, „Push in“ technology for tool free connections, clear display of signal status via LEDs, degree of protection IP20 For usage in combination with piconet® extension modules SNNE-0808D-0003.	<b>SNNE-BL I/O 3,5-30/LED-SET</b>	6824474



**piconet® – SUB-D connector IP67**

Figure	Description	Type	Ident-No.
	25-pole SUB-D connector, degree of protection IP67, for cable mounting. For connection cables with outer diameter between 6 and 10mm. For usage in combination with piconet® extension module SNNE-0016D-000x.	<b>SUB-D-IP67</b>	6901390

**piconet® – Sets**

Description	Type	Ident-No.
<b>Parts list piconet® set M8:</b> 1 x M12 end cap, 9 x M8 end caps, 2 x fibre-optic cable blanking plugs 1 x frame with 10 lables, 2 x M8 blanking plugs, 1 x M12 blanking plug	<b>piconet®-Set-M8</b>	8015078
<b>Parts list piconet® set-M12:</b> 5 x M12, 1 x M8 end caps, 2 x fibre-optic blanking plugs 1 x frame with 10 lables, 2 x M8 blanking plugs, 1 x M12 blanking plug	<b>piconet®-Set-M12</b>	8015076

**piconet® – Planning and configuration software I/O-ASSISTANT and adapter cable**

Figure	Description	Type	Ident-No.
	RS232 adapter cable	<b>I/O-ASSISTANT-KABEL-PICONET</b>	6824399
	Planning and configuration software	<b>SW-I/O-ASSISTANT</b>	freeware for download on: <a href="http://www.turck.com">http://www.turck.com</a>

# **piconet® – Special accessories**

## **piconet® – Thermoelement compensation connector**

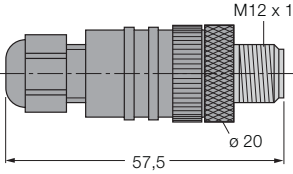
Figure	Description	Type	Ident-No.
	Thermoelement compensation connector, M12 x 1	<b>WAS5-THERMO</b>	6824260

## **Earthing clip for piconet® modules**

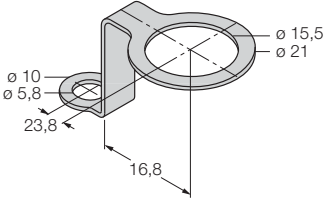
Figure	Description	Type	Ident-No.
	Earthing clip for <i>piconet®</i> modules	<b>EL-0002</b>	8030476

## **Mounting plate for piconet® housings to be mounted on a DIN-rail (hat-rail)**

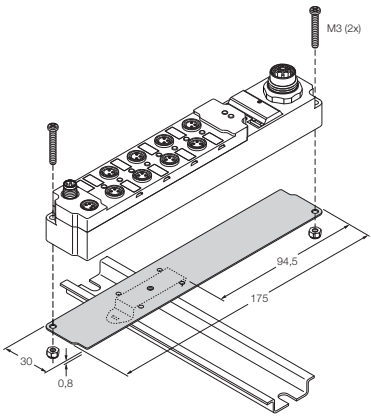
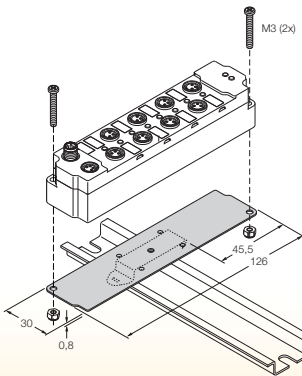
Figure	Description	Type	Ident-No.
	<p>Mounting plate for mounting the <i>piconet®</i> coupling and stand-alone modules (housing length: 175 mm) on a hat-rail.</p> <p>Mounting instructions:</p> <ol style="list-style-type: none"> <li>1. Module carrier clip (1) with base plate (2) to be fixed via a blind rivet (included in delivery)</li> <li>2. Housing base plate to be mounted on the module via screws and coupling nuts (included in delivery).</li> <li>3. Finally let the module snap on the hat-rail via the module carrier clip.</li> </ol>	<b>S-BKT1</b>	6603930
	<p>Mounting plate for mounting <i>piconet®</i> extension modules (housing length: 126 mm) on a hat-rail.</p> <p>Mounting instructions:</p> <ol style="list-style-type: none"> <li>1. Module carrier clip (1) and base plate (2) to be fixed via a blind rivet (included in delivery)</li> <li>2. Housing base plate to be mounted on the module via screws and coupling nuts (included in delivery).</li> <li>3. Finally let the module snap on the hat-rail via the module carrier clip.</li> </ol>	<b>S-BKT2</b>	6603931

**piconet® – Power junction boxes**

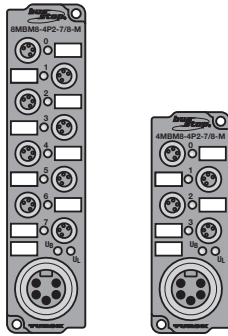

- Power junction for *piconet*® stations
- Robust and fully encapsulated polyamide housing

**⚠ ATTENTION:**

*piconet*® power junctions may be powered with a current of max. 9 A each. A maximum of 4 A can be drawn from the power junction per channel. The junctions have to be protected with correspondent fuse elements at the power connector (7/8") and the outputs (M8)!

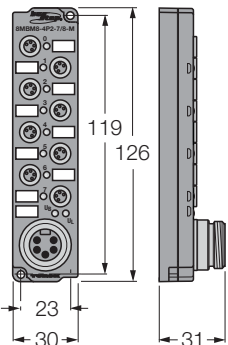
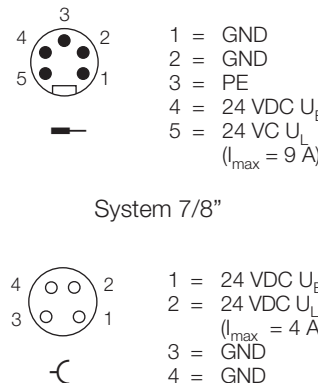
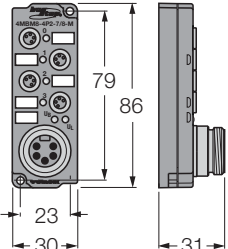
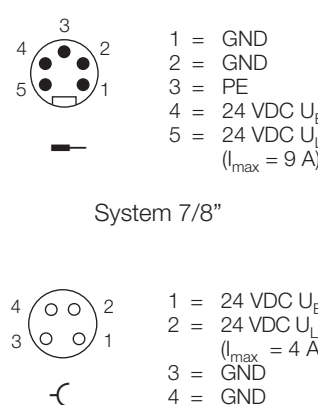
Type/Ident-No.	Description	Pin configuration
<p><b>8MBM8-4P2-7/8-M</b> Ident-No. 8017216</p> 	<p>8-port power junction</p> <ul style="list-style-type: none"> <li>– max. 4 A per channel</li> <li>– small housing style</li> <li>– fully encapsulated plastic housing</li> <li>– degree of protection IP67</li> </ul>	 <p>System 7/8"</p> <p>System M8 x 1</p>
<p><b>4MBM8-4P2-7/8-M</b> Ident-No. 8017217</p> 	<p>4-port power junction</p> <ul style="list-style-type: none"> <li>– max. 4 A per channel</li> <li>– small housing style</li> <li>– fully encapsulated plastic housing</li> <li>– degree of protection IP67</li> </ul>	 <p>System 7/8"</p> <p>System M8 x 1</p>

# piconet® - Module dimensions (Drilling Templates)

Side view

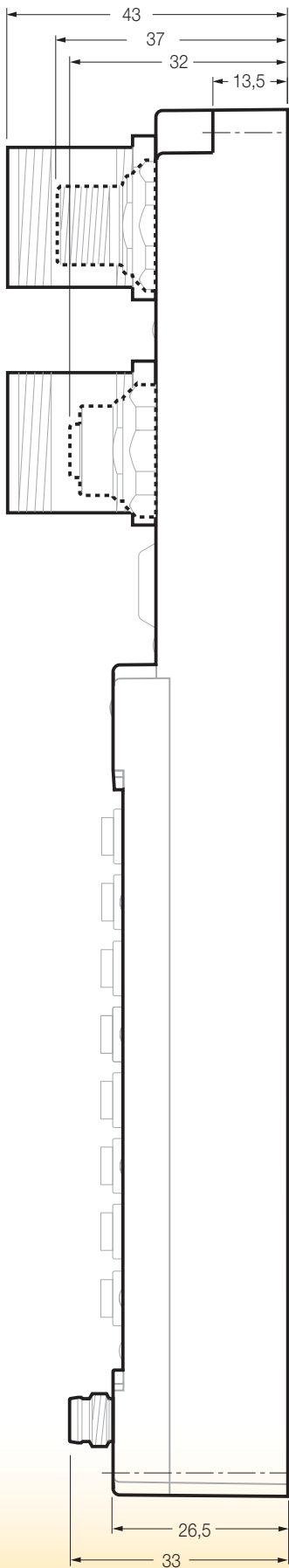

Coupling and stand-alone modules

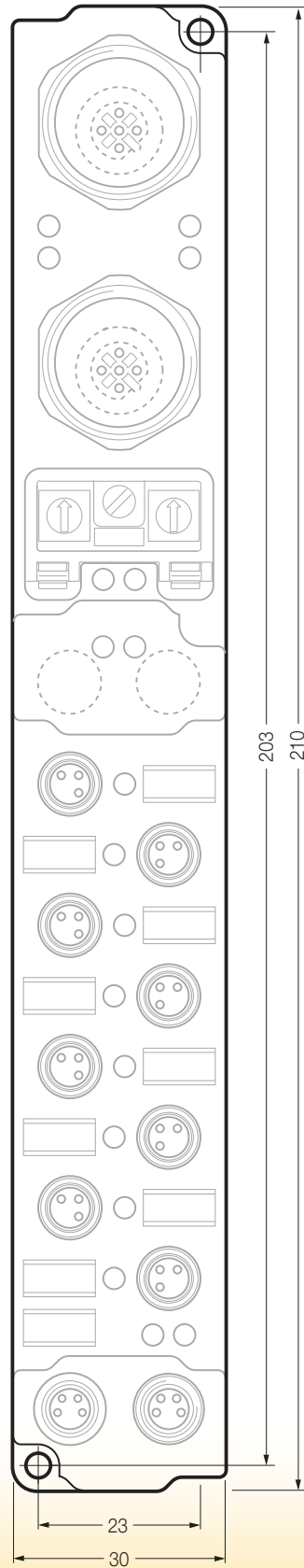

Coupling and stand-alone modules

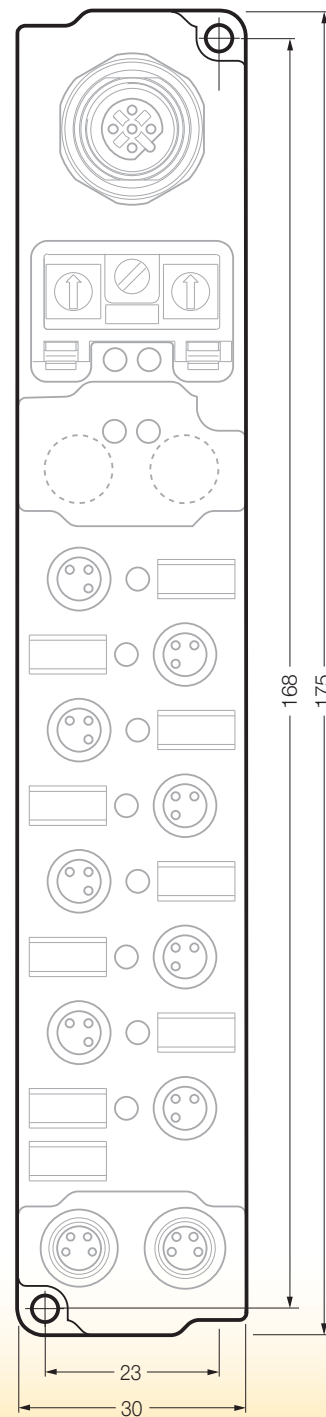

Extension modules

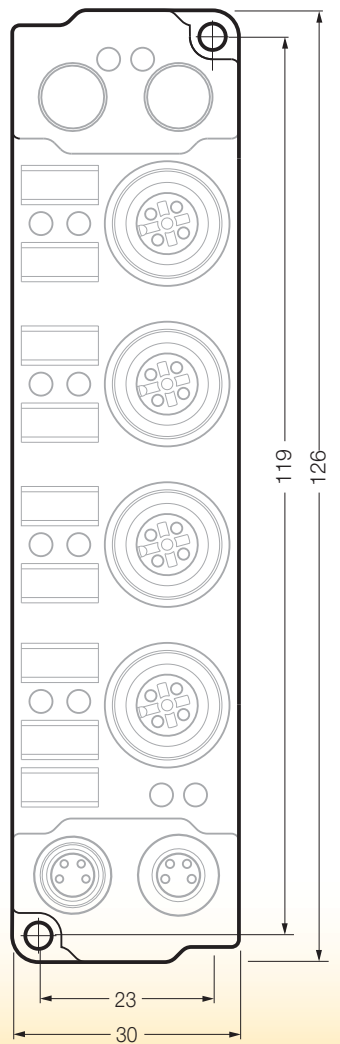





# **piconet® – Coupling modules**

## **piconet® – coupling modules**

## **Page**

PROFIBUS-DP	132
DeviceNet™	134
CANopen	136
INTERBUS	138
Modbus TCP	140
EtherNet/IP	142
PROFINET	144

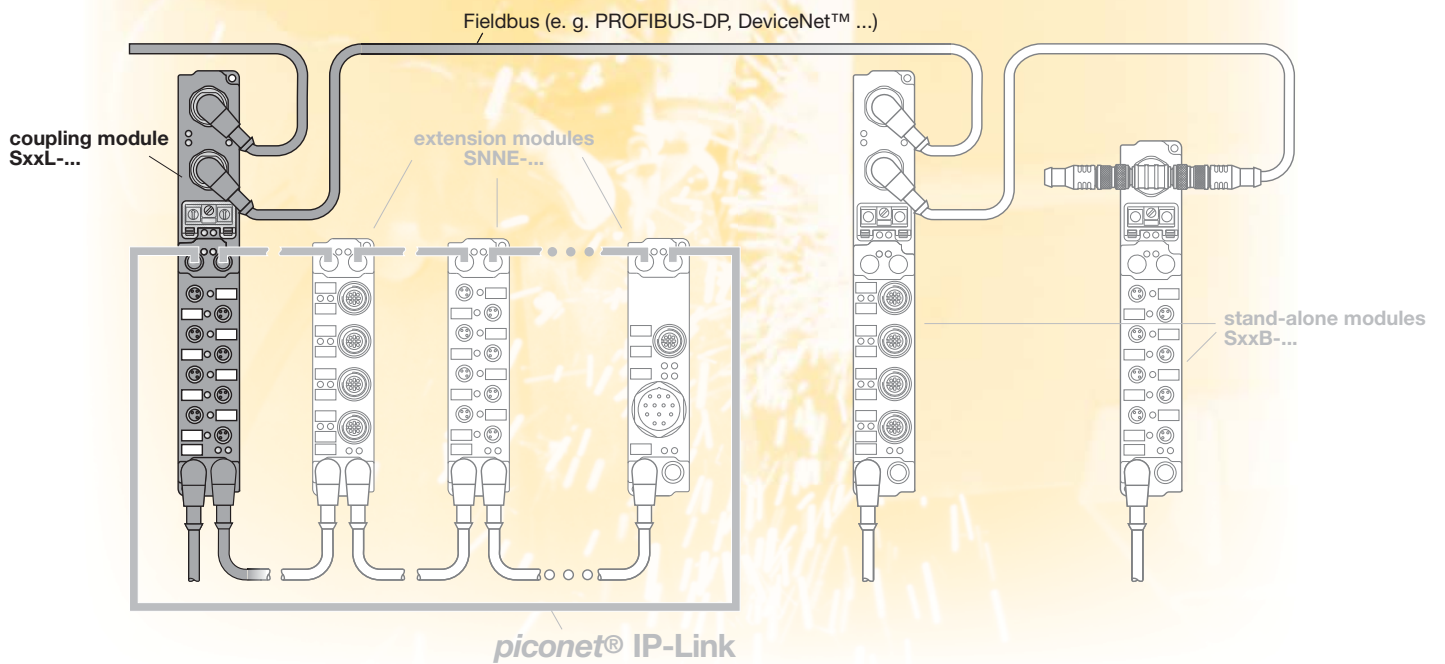

## **piconet® – Coupling modules**

*piconet®* coupling modules are the gateway between the higher level fieldbus (e.g. PROFIBUS-DP, Device-Net™, CANopen, INTERBUS, Modbus TCP, EtherNet/IP and PROFINET) and the fibre-optic based *piconet®* sub-bus “IP-Link”. Depending on the type of coupling module, they are equipped with one or two fieldbus connections and two further connectors for connection to the *piconet®* IP-Link.

On basis of the IP-Link, it is possible to construct a modular network, for operation of up to 120 extension modules per coupling module.

The coupling module collects the I/O data of the connected extension modules via the interference immune and fast (2 Mbps) IP-Link network.

The transmission time for 1,000 I/Os is approx. 1 ms – if less data are transferred the transmission speed is even higher. The maximum fibre-optic cable length is 15 m.

The robust IP67 housing is extremely compact, fully encapsulated and equipped throughout with metal connectors. As a result, our *piconet®* modules are suited for application both in rough industrial

environments as well as in space-critical applications in serial and special machine engineering.

Operating and load voltage are – as with all *piconet®* module types – fed separately. Alongside the “Power” LED, each channel is assigned a “Status” LED for switching status indications.

### **piconet® – coupling modules – general technical data**

#### **Adjustment**

Fieldbus address	1...99 (decimal), adjustable via coded rotary switches
Transmission rate	automatic

#### **LED indications (module-specific)**

Fieldbus	fieldbus specific (s. manual)
Status IP-Link or module (local errors)	
– green LED flashing/ON – red LED OFF:	receipt of error-free IP-Link protocols
– green LED flashing/red LED flashing:	receipt of faulty IP-Link protocols (must not lead to a system error)
– green LED OFF/red LED flashing:	receipt of faulty IP-Link protocols
– green LED OFF/red LED ON:	no data transfer via the IP-Link or module error
Operating voltage $U_B$	green: operational
Load voltage $U_L$	green: operational

#### **Connections**

Fieldbus	brass, nickel-plated
IP-Link	depending on the type of fieldbus system used
Length of fibre-optic cable	(2) IP-Link female connectors max. 15 m
Power supply	(1) M8 male connectors, 4-pole, (1) M8 female connectors, 4-pole
Inputs/outputs	selectable: (8) M8 female connectors, 3-pole, or (4) M12 female connectors, 5-pole
Service interface	(1) terminal strip, 5-pole (for I/O-ASSISTANT)

#### **Housing**

Material	compact, fully encapsulated plastic housing PA6 (Polyamid)
Dimensions – device with 1 fieldbus connection	175 x 30 x 26.5 mm (H x W x D)
Dimensions – device with 2 fieldbus connections	210 x 30 x 26.5 mm (H x W x D)
Mounting	via 2 through-holes, Ø 3 mm
Mounting position	any
Operating temperature (range)	0 °C to +55 °C (+32 °F to +131 °F)
Operating temperature (storage)	-25 °C to +85 °C (-13 °F to +185 °F)
Degree of protection (IEC 60529/EN 60529)	IP65, IP66, IP67
Vibration and shock testing	according to IEC 68, part 2-6 / IEC 68, part 2-27
Electromagnetic capability (EMC)	according to EN 50081-2/EN 50082-2
Weight	approx. 250–280 g (depending on type)
Approvals	CE, 



**Please note:** further technical information is contained in the *piconet®* user manuals.

**piconet® coupling module for PROFIBUS-DP**  
**4 digital pnp inputs filter 3 ms**  
**4 digital outputs 0.5 A**

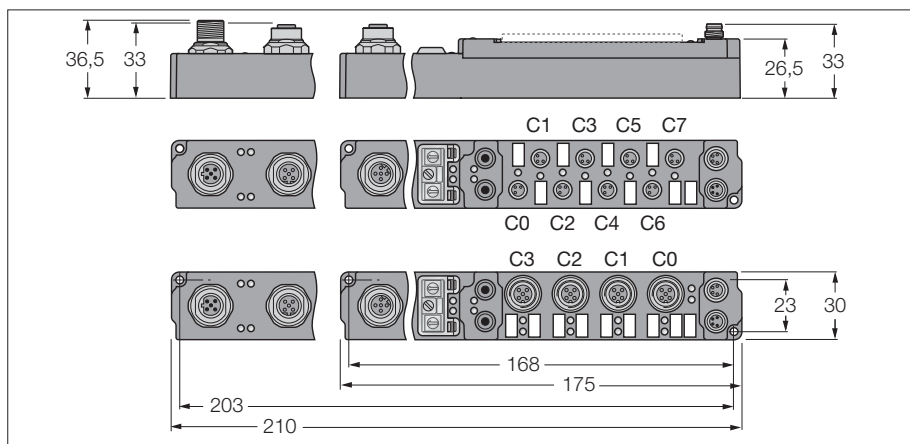

- 4 digital pnp inputs
- 4 digital outputs 0.5 A
- Input filter 3 ms
- Configuration interface
- Parameterisable functions
- Supported via I/O-ASSISTANT
- Direct connection to the fieldbus
- Direct connection to the IP link
- Fibre-glass reinforced PA6 housing
- Encapsulated module electronics
- Metal connector
- Degree of Protection IP67

<b>Operating / load voltage</b>	20...29 VDC
Operating current	≤ 100 mA
<b>Fieldbus transmission rate</b>	9.6 kbps up to 12 Mbps
Fieldbus addressing	0 to 99
Service interface	parameterisation via I/O-ASSISTANT
Electrical isolation	Fieldbus to operational voltage
<b>Fibre-optic length</b>	≤ 15 m
<b>Inputs</b>	
Number of channels	4 digital inputs acc. to EN 61131-2
Input voltage	20...29 VDC via operating voltage
Supply current	< 500 mA per channel, short-circuit proof
Low level signal voltage	-3...5 VDC (EN 61131-2, type 2)
High level signal voltage	11...30 VDC (EN 61131-2, type 2)
Input delay	3 ms
Max. input current	6 mA
<b>Outputs</b>	
Number of channels	4 digital outputs acc. to EN 61131-2
Output voltage	20...29 VDC from load voltage
Output current per channel	0.5 A, short-circuit proof
Load type	resistive, inductive, lamp load
Switching frequency	≤ 500 Hz
Simultaneity factor	1
<b>Operating temperature</b>	0 to 55 °C

**Data in process image**

			Bit 7	Bit 6	Bit 5	Bit 4	Bit 3	Bit 2	Bit 1	Bit 0	
Byte alignment disabled (default). Up to 4 bit input and 4 bit output data are mapped.	<b>Input</b>	<b>Byte n (M8)</b>	Is used by the physically following bit-oriented extension module connected via the IP Link.				C3P4	C2P4	C1P4	C0P4	
		<b>Byte n (M12)</b>					C1P2	C1P4	C0P2	C0P4	
	<b>Output</b>	<b>Byte n (M8)</b>					C7P4	C6P4	C5P4	C4P4	
		<b>Byte n (M12)</b>					C3P2	C3P4	C2P2	C2P4	
Byte alignment enabled. Up to 8 bit input data and 8 bit output data are mapped.	<b>Input</b>	<b>Byte n (M8)</b>	idle	idle	idle	idle	C3P4	C2P4	C1P4	C0P4	
		<b>Byte n (M12)</b>	idle	idle	idle	idle	C1P2	C1P4	C0P2	C0P4	
	<b>Output</b>	<b>Byte n (M8)</b>	C7P4	C6P4	C5P4	C4P4	idle	idle	idle	idle	
		<b>Byte n (M12)</b>	C3P2	C3P4	C2P2	C2P4	idle	idle	idle	idle	

C... = Connector No. – P... = Pin No.

**piconet® coupling module for PROFIBUS-DP**  
**4 digital pnp inputs filter 3 ms**  
**4 digital outputs 0.5 A**

**Device types**

Dimensions	Type	Connection
	<b>6824173 SDPL-0404D-0003</b>	F083, F077, F079, F081
	<b>6824175 SDPL-0404D-0004</b>	F083, F117, F118, F081
	<b>6824450 SDPL-0404D-1003</b>	F084, F077, F079, F081
	<b>6824451 SDPL-0404D-1004</b>	F084, F117, F118, F081

**3**

**Connection**

F083 - Fieldbus M12 x 1

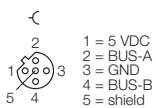

F077 - Input M8 x 1

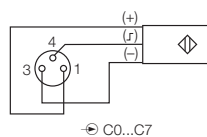

F079 - Output M8 x 1

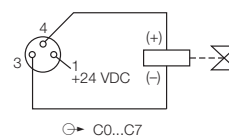

F081 - Voltage supply M8 x 1

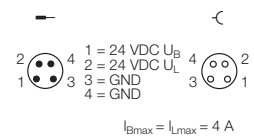

F084 - Fieldbus M12 x 1

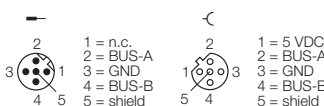

F117 - Input M12 x 1

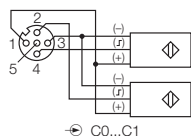

F118 - Output M12 x 1

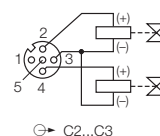

**piconet® coupling module for DeviceNet**  
**4 digital pnp inputs filter 3 ms**  
**4 digital outputs 0.5 A**

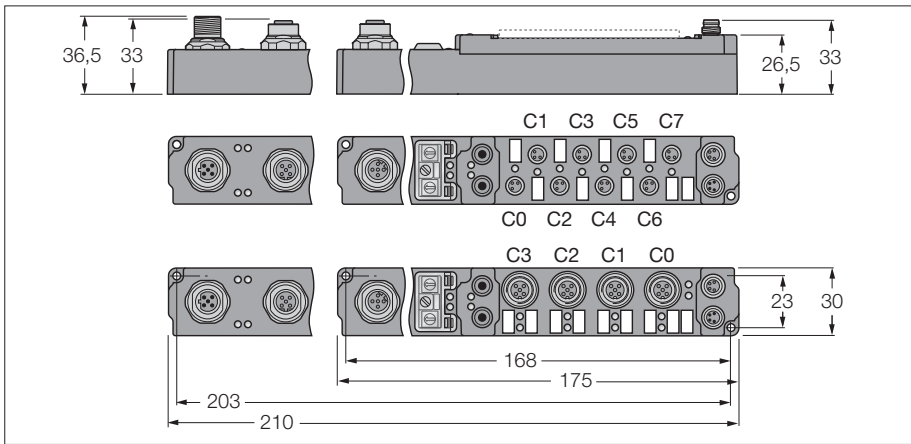

- 4 digital pnp inputs
- 4 digital outputs 0.5 A
- Input filter 3 ms
- Configuration interface
- Parameterisable functions
- Supported via I/O-ASSISTANT
- Direct connection to the fieldbus
- Direct connection to the IP link
- Fibre-glass reinforced PA6 housing
- Encapsulated module electronics
- Metal connector
- Degree of Protection IP67

<b>Operating / load voltage</b>	20...29 VDC
Operating current	≤ 60 mA
<b>Fieldbus transmission rate</b>	125 kbps to 500 kbps
Fieldbus addressing	0 to 99
Service interface	parameterisation via I/O-ASSISTANT
Electrical isolation	Fieldbus to operational voltage
<b>Fibre-optic length</b>	≤ 15 m
<b>Inputs</b>	
Number of channels	4 digital inputs acc. to EN 61131-2
Input voltage	20...29 VDC via operating voltage
Supply current	< 500 mA per channel, short-circuit proof
Low level signal voltage	-3...5 VDC (EN 61131-2, type 2)
High level signal voltage	11...30 VDC (EN 61131-2, type 2)
Input delay	3 ms
Max. input current	6 mA
<b>Outputs</b>	
Number of channels	4 digital outputs acc. to EN 61131-2
Output voltage	20...29 VDC from load voltage
Output current per channel	0.5 A, short-circuit proof
Load type	resistive, inductive, lamp load
Switching frequency	≤ 500 Hz
Simultaneity factor	1
<b>Operating temperature</b>	0 to 55 °C

**Data in process image**

		Bit 7	Bit 6	Bit 5	Bit 4	Bit 3	Bit 2	Bit 1	Bit 0	
Each 4 bit input and 4 bit output data are mapped.	<b>Input</b>	Byte n (M8)	Is used by the physically following bit-oriented extension module connected via the IP Link.				C3P4	C2P4	C1P4	C0P4
		Byte n (M12)					C1P2	C1P4	C0P2	C0P4
	<b>Output</b>	Byte n (M8)					C7P4	C6P4	C5P4	C4P4
		Byte n (M12)					C3P2	C3P4	C2P2	C2P4

C... = Connector no., P... = Pin no.

**piconet® coupling module for DeviceNet**  
**4 digital pnp inputs filter 3 ms**  
**4 digital outputs 0.5 A**

**Device types**

Dimensions	Type	Connection
	<b>6824227 SDNL-0404D-0003</b>	F119, F077, F079, F081
	<b>6824225 SDNL-0404D-0004</b>	F119, F117, F118, F081
	<b>6824457 SDNL-0404D-1003</b>	F085, F077, F079, F081
	<b>6824453 SDNL-0404D-1004</b>	F085, F117, F118, F081

**3**

**Connection**

F119 - Fieldbus M12 x 1

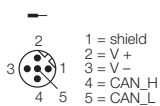

F077 - Input M8 x 1

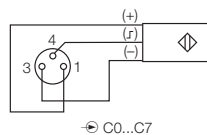

F079 - Output M8 x 1

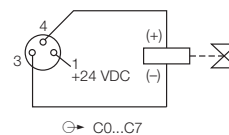

F081 - Voltage supply M8 x 1

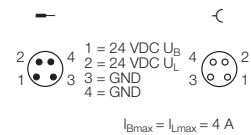

F085 - Fieldbus M12 x 1

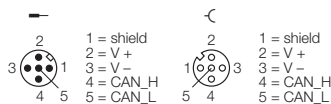

F117 - Input M12 x 1

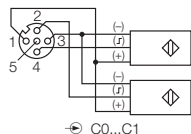

F118 - Output M12 x 1

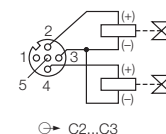

**piconet® coupling module for CANOpen**  
**4 digital pnp inputs filter 3 ms**  
**4 digital outputs 0.5 A**

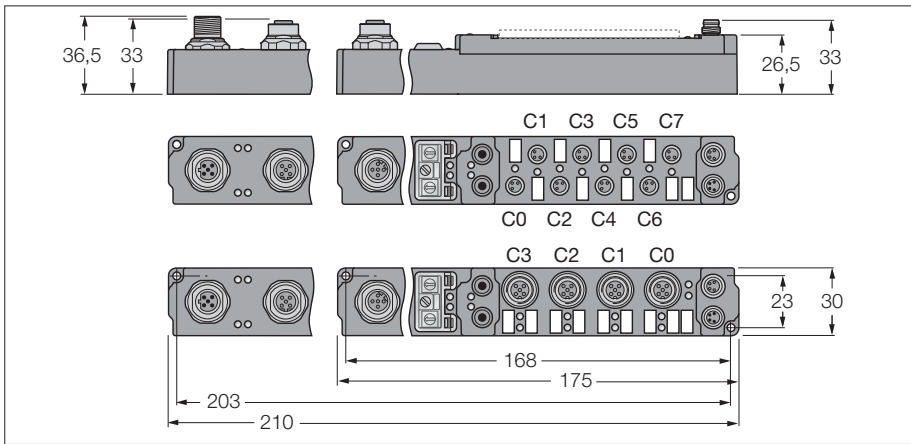

- 4 digital pnp inputs
- 4 digital outputs 0.5 A
- Input filter 3 ms
- Configuration interface
- Parameterisable functions
- Supported via I/O-ASSISTANT
- Direct connection to the fieldbus
- Direct connection to the IP link
- Fibre-glass reinforced PA6 housing
- Encapsulated module electronics
- Metal connector
- Degree of Protection IP67

<b>Operating / load voltage</b>	20...29 VDC
Operating current	≤ 60 mA
<b>Fieldbus transmission rate</b>	10 kbps up to 1 Mbps
Fieldbus addressing	0 to 99
Service interface	parameterisation via I/O-ASSISTANT
Electrical isolation	Fieldbus to operational voltage
<b>Fibre-optic length</b>	≤ 15 m
<b>Inputs</b>	
Number of channels	4 digital inputs acc. to EN 61131-2
Input voltage	20...29 VDC via operating voltage
Supply current	< 500 mA per channel, short-circuit proof
Low level signal voltage	-3...5 VDC (EN 61131-2, type 2)
High level signal voltage	11...30 VDC (EN 61131-2, type 2)
Input delay	3 ms
Max. input current	6 mA
<b>Outputs</b>	
Number of channels	4 digital outputs acc. to EN 61131-2
Output voltage	20...29 VDC from load voltage
Output current per channel	0.5 A, short-circuit proof
Load type	resistive, inductive, lamp load
Switching frequency	≤ 500 Hz
Simultaneity factor	1
<b>Operating temperature</b>	0 to 55 °C

**Data in process image**

		Bit 7	Bit 6	Bit 5	Bit 4	Bit 3	Bit 2	Bit 1	Bit 0	
Each 4 bit input and 4 bit output data are mapped.	<b>Input</b>	<b>Byte n (M8)</b>	Is used by the physically following bit-oriented extension module connected via the IP Link.				C3P4	C2P4	C1P4	C0P4
		<b>Byte n (M12)</b>					C1P2	C1P4	C0P2	C0P4
	<b>Output</b>	<b>Byte n (M8)</b>					C7P4	C6P4	C5P4	C4P4
		<b>Byte n (M12)</b>					C3P2	C3P4	C2P2	C2P4

C... = Connector no., P... = Pin no.



**piconet® coupling module for CANopen**  
**4 digital pnp inputs filter 3 ms**  
**4 digital outputs 0.5 A**

**Device types**

Dimensions	Type	Connection
	<b>6824221 SCOL-0404D-0003</b>	F119, F077, F079, F081
	<b>6824219 SCOL-0404D-0004</b>	F119, F117, F118, F081
	<b>6824454 SCOL-0404D-1003</b>	F085, F077, F079, F081
	<b>6824456 SCOL-0404D-1004</b>	F085, F117, F118, F081

3

**Connection**

F119 - Fieldbus M12 x 1

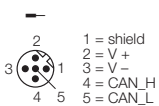

F077 - Input M8 x 1

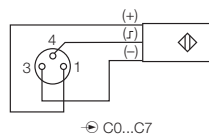

F079 - Output M8 x 1

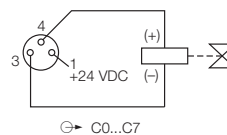

F081 - Voltage supply M8 x 1

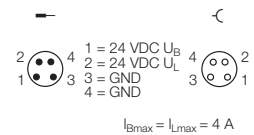

F085 - Fieldbus M12 x 1

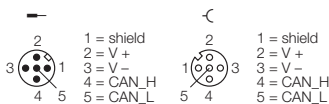

F117 - Input M12 x 1

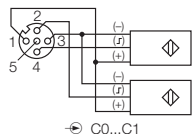

F118 - Output M12 x 1

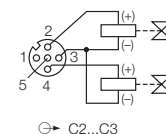

**piconet® coupling module for INTERBUS**  
**4 digital pnp inputs filter 3 ms**  
**4 digital outputs 0.5 A**

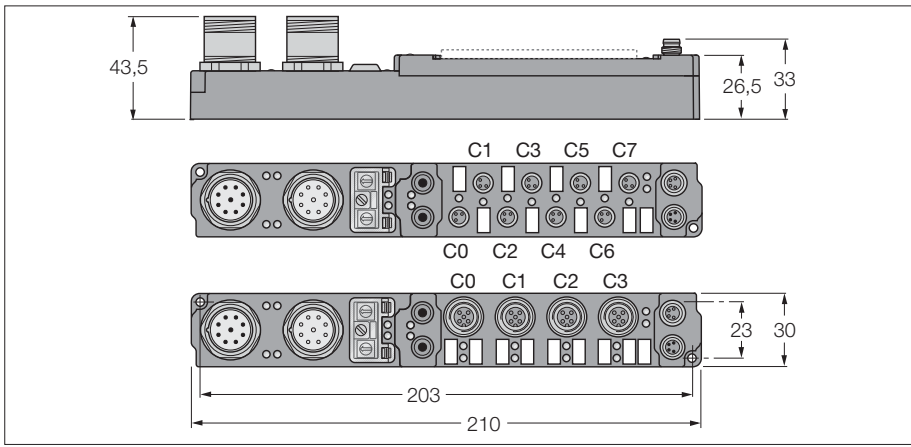

- 4 digital pnp inputs
- 4 digital outputs 0.5 A
- Input filter 3 ms
- Configuration interface
- Parameterisable functions
- Supported via I/O-ASSISTANT
- Direct connection to the fieldbus
- Direct connection to the IP link
- Fibre-glass reinforced PA6 housing
- Encapsulated module electronics
- Metal connector
- Degree of Protection IP67

<b>Operating / load voltage</b>	20...29 VDC
Operating current	≤ 100 mA
<b>Fieldbus transmission rate</b>	500 kbps
Fieldbus addressing	0 to 99
Service interface	parameterisation via I/O-ASSISTANT
Electrical isolation	fieldbus to operational voltage
<b>Fibre-optic length</b>	≤ 15 m
<b>Inputs</b>	
Number of channels	4 digital inputs acc. to EN 61131-2
Input voltage	20...29 VDC via operating voltage
Supply current	< 500 mA per channel, short-circuit proof
Low level signal voltage	-3...5 VDC (EN 61131-2, type 2)
High level signal voltage	11...30 VDC (EN 61131-2, type 2)
Input delay	3 ms
Max. input current	6 mA
<b>Outputs</b>	
Number of channels	4 digital outputs acc. to EN 61131-2
Output voltage	20...29 VDC from load voltage
Output current per channel	0.5 A, short-circuit proof
Load type	resistive, inductive, lamp load
Switching frequency	≤ 500 Hz
Simultaneity factor	1
<b>Operating temperature</b>	0 to 55 °C

**Data in process image**

		Bit 7	Bit 6	Bit 5	Bit 4	Bit 3	Bit 2	Bit 1	Bit 0	
Each 4 bit input and 4 bit output data are mapped.	<b>Input</b>	<b>Byte n (M8)</b>	Is used by the physically following bit-oriented extension module connected via the IP Link.				C3P4	C2P4	C1P4	C0P4
		<b>Byte n (M12)</b>					C1P2	C1P4	C0P2	C0P4
	<b>Output</b>	<b>Byte n (M8)</b>					C7P4	C6P4	C5P4	C4P4
		<b>Byte n (M12)</b>					C3P2	C3P4	C2P2	C2P4

C... = Connector no., P... = Pin no.

**piconet® coupling module for INTERBUS**  
**4 digital pnp inputs filter 3 ms**  
**4 digital outputs 0.5 A**

**Device types**

Dimensions	Type	Connection
	<b>6824224 SIBL-0404D-0003</b>	F109, F077, F079, F081
	<b>6824222 SIBL-0404D-0004</b>	F109, F117, F118, F081

**Connection**

F109 - Fieldbus M23 x 1

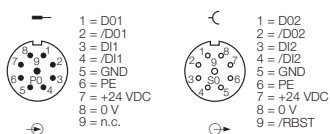

F117 - Input M12 x 1

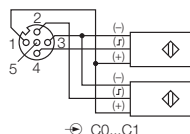

F118 - Output M12 x 1

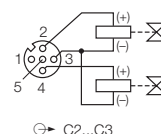

F077 - Input M8 x 1

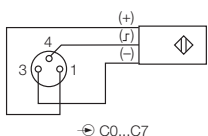

F079 - Output M8 x 1

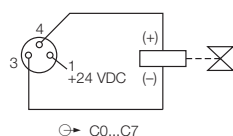

F081 - Voltage supply M8 x 1

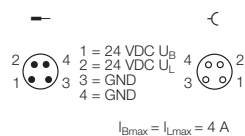

# piconet® coupling module for Modbus TCP

4 digital pnp inputs filter 3 ms

4 digital outputs 0.5 A

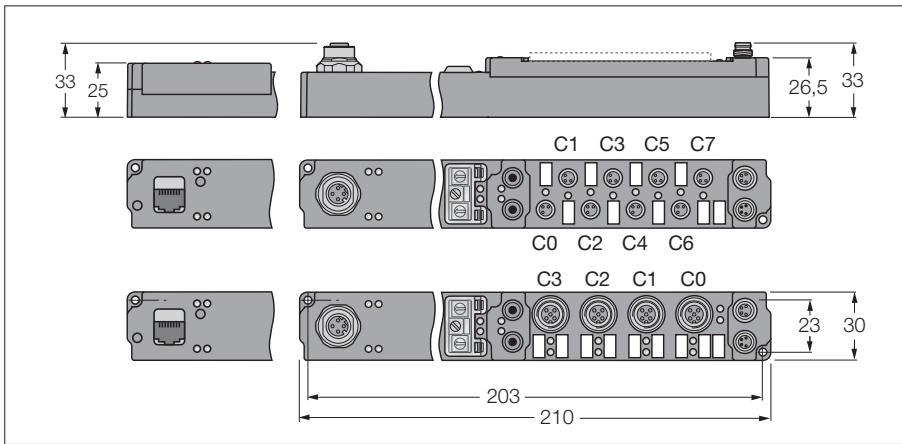

- 4 digital pnp inputs
- 4 digital outputs 0.5 A
- Input filter 3 ms
- Configuration interface
- Parameterisable functions
- Supported via I/O-ASSISTANT
- Direct connection to the fieldbus
- Direct connection to the IP link
- Fibre-glass reinforced PA6 housing
- Encapsulated module electronics
- Metal connector
- Degree of Protection IP67

<b>Operating / load voltage</b>	20...29 VDC
Operating current	≤ 100 mA
<b>Transmission rate Ethernet</b>	10 Mbps / 100 Mbps
Addressing modes Ethernet:	via coded rotary switches
Service interface	parameterisation via I/O-ASSISTANT
Electrical isolation	fieldbus to operational voltage
<b>Fibre-optic length</b>	≤ 15 m
<b>Inputs</b>	
Number of channels	4 digital inputs acc. to EN 61131-2
Input voltage	20...29 VDC via operating voltage
Supply current	< 500 mA per channel, short-circuit proof
Low level signal voltage	-3...5 VDC (EN 61131-2, type 2)
High level signal voltage	11...30 VDC (EN 61131-2, type 2)
Input delay	3 ms
Max. input current	6 mA
<b>Outputs</b>	
Number of channels	4 digital outputs acc. to EN 61131-2
Output voltage	20...29 VDC from load voltage
Output current per channel	0.5 A, short-circuit proof
Load type	resistive, inductive, lamp load
Switching frequency	≤ 500 Hz
Simultaneity factor	1
<b>Operating temperature</b>	0 to 55 °C

## Data in process image

		Bit 7	Bit 6	Bit 5	Bit 4	Bit 3	Bit 2	Bit 1	Bit 0	
Each 4 bit input and 4 bit output data are mapped.	<b>Input</b>	Byte n (M8)	Is used by the physically following bit-oriented extension module connected via the IP Link.				C3P4	C2P4	C1P4	C0P4
		Byte n (M12)					C1P2	C1P4	C0P2	C0P4
	<b>Output</b>	Byte n (M8)					C7P4	C6P4	C5P4	C4P4
		Byte n (M12)					C3P2	C3P4	C2P2	C2P4

C... = Connector no., P... = Pin no.

**piconet® coupling module for Modbus TCP**  
**4 digital pnp inputs filter 3 ms**  
**4 digital outputs 0.5 A**

**Device types**

Dimensions	Type	Connection
	<b>6824480 SENL-0404D-0001</b>	F120, F077, F079, F081
	<b>6824481 SENL-0404D-0002</b>	F120, F117, F118, F081
	<b>6824242 SENL-0404D-0003</b>	F105, F077, F079, F081
	<b>6824240 SENL-0404D-0004</b>	F105, F117, F118, F081

**3**

**Connection**

F120 - Ethernet M12 x 1

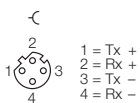

F077 - Input M8 x 1

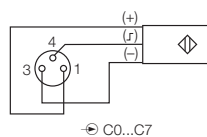

F079 - Output M8 x 1

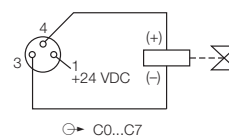

F081 - Voltage supply M8 x 1

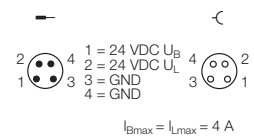

F105 - Fieldbus RJ45

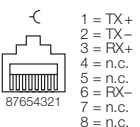

F117 - Input M12 x 1

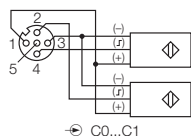

F118 - Output M12 x 1

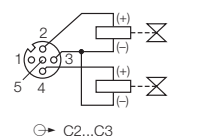

**piconet® coupling module for EtherNet/IP**  
**4 digital pnp inputs filter 3 ms**  
**4 digital outputs 0.5 A**

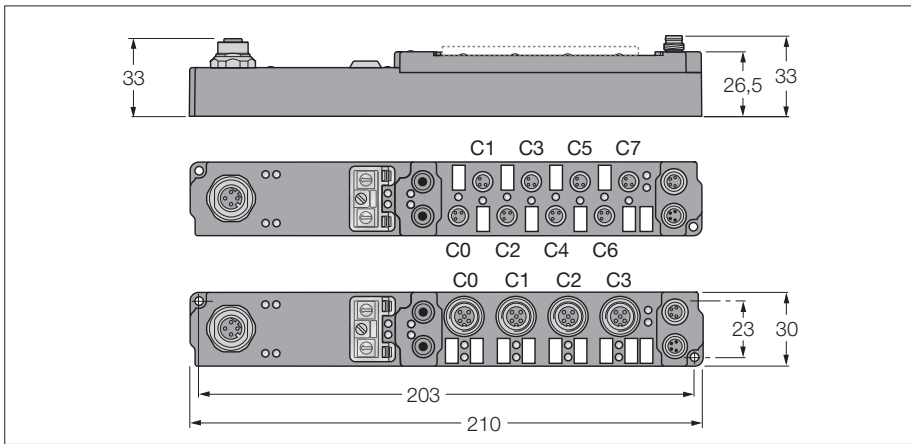

- 4 digital pnp inputs
- 4 digital outputs 0.5 A
- Input filter 3 ms
- Configuration interface
- Parameterisable functions
- Supported via I/O-ASSISTANT
- Direct connection to the fieldbus
- Direct connection to the IP link
- Fibre-glass reinforced PA6 housing
- Encapsulated module electronics
- Metal connector
- Degree of Protection IP67

<b>Operating / load voltage</b>	20...29 VDC
Operating current	≤ 100 mA
<b>Transmission rate Ethernet</b>	10 Mbps / 100 Mbps
Addressing modes Ethernet:	via coded rotary switches
Service interface	parameterisation via I/O-ASSISTANT
Electrical isolation	ethernet for operating voltage
<b>Fibre-optic length</b>	≤ 15 m
<b>Inputs</b>	
Number of channels	4 digital inputs acc. to EN 61131-2
Input voltage	20...29 VDC via operating voltage
Supply current	< 500 mA per channel, short-circuit proof
Low level signal voltage	-3...5 VDC (EN 61131-2, type 2)
High level signal voltage	11...30 VDC (EN 61131-2, type 2)
Input delay	3 ms
Max. input current	6 mA
<b>Outputs</b>	
Number of channels	4 digital outputs acc. to EN 61131-2
Output voltage	20...29 VDC from load voltage
Output current per channel	0.5 A, short-circuit proof
Load type	resistive, inductive, lamp load
Switching frequency	≤ 500 Hz
Simultaneity factor	1
<b>Operating temperature</b>	0 to 55 °C

**Data in process image**

		Bit 7	Bit 6	Bit 5	Bit 4	Bit 3	Bit 2	Bit 1	Bit 0	
Each 4 bit input and 4 bit output data are mapped.	<b>Input</b>	Byte n (M8)	Is used by the physically following bit-oriented extension module connected via the IP Link.				C3P4	C2P4	C1P4	C0P4
		Byte n (M12)					C1P2	C1P4	C0P2	C0P4
	<b>Output</b>	Byte n (M8)					C7P4	C6P4	C5P4	C4P4
		Byte n (M12)					C3P2	C3P4	C2P2	C2P4

C... = Connector no., P... = Pin no.

**piconet® coupling module for EtherNet/IP**  
**4 digital pnp inputs filter 3 ms**  
**4 digital outputs 0.5 A**

**Device types**

Dimensions	Type	Connection
	<b>6824472 SIPL-0404D-0003</b>	F120, F077, F079, F081
	<b>6824471 SIPL-0404D-0004</b>	F120, F117, F118, F081

**Connection**

F120 - Ethernet M12 x 1

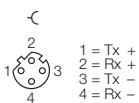

F117 - Input M12 x 1

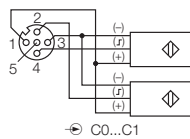

F118 - Output M12 x 1

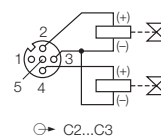

F077 - Input M8 x 1

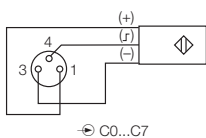

F079 - Output M8 x 1

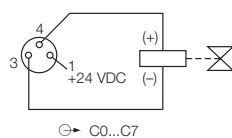

F081 - Voltage supply M8 x 1

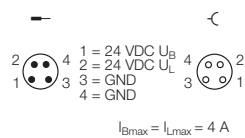

**piconet® coupling module for PROFINET**  
**4 digital pnp inputs filter 3 ms**  
**4 digital outputs 0.5 A**

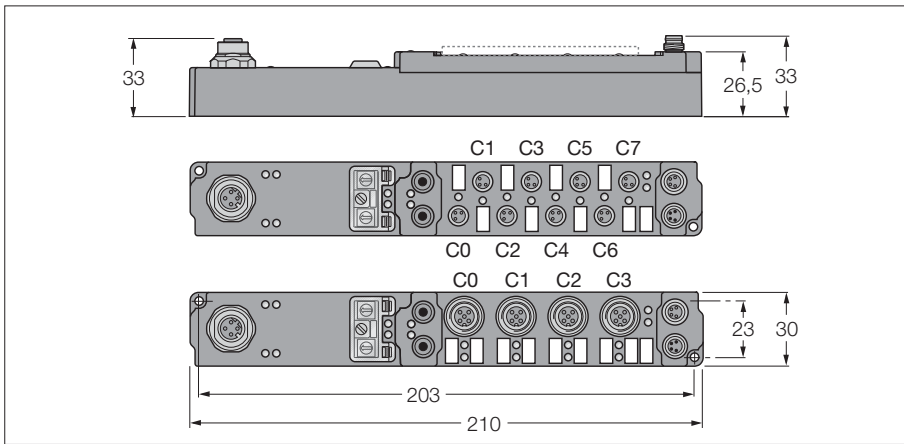

- 4 digital pnp inputs
- 4 digital outputs 0.5 A
- Input filter 3 ms
- Configuration interface
- Parameterisable functions
- Supported via I/O-ASSISTANT
- Direct connection to the fieldbus
- Direct connection to the IP link
- Fibre-glass reinforced PA6 housing
- Encapsulated module electronics
- Metal connector
- Degree of Protection IP67

<b>Operating / load voltage</b>	20...29 VDC
Operating current	≤ 100 mA
<b>Transmission rate Ethernet</b>	10 Mbps / 100 Mbps
Addressing modes Ethernet:	via coded rotary switches
Service interface	parameterisation via I/O-ASSISTANT
Electrical isolation	fieldbus to operational voltage
<b>Fibre-optic length</b>	≤ 15 m
<b>Inputs</b>	
Number of channels	4 digital inputs acc. to EN 61131-2
Input voltage	20...29 VDC via operating voltage
Supply current	< 500 mA per channel, short-circuit proof
Low level signal voltage	-3...5 VDC (EN 61131-2, type 2)
High level signal voltage	11...30 VDC (EN 61131-2, type 2)
Input delay	3 ms
Max. input current	6 mA
<b>Outputs</b>	
Number of channels	4 digital outputs acc. to EN 61131-2
Output voltage	20...29 VDC from load voltage
Output current per channel	0.5 A, short-circuit proof
Load type	resistive, inductive, lamp load
Switching frequency	≤ 500 Hz
Simultaneity factor	1
<b>Operating temperature</b>	0 to 55 °C

**Data in process image**

		Bit 7	Bit 6	Bit 5	Bit 4	Bit 3	Bit 2	Bit 1	Bit 0	
Each 4 bit input and 4 bit output data are mapped.	<b>Input</b>	Byte n (M8)	Is used by the physically following bit-oriented extension module connected via the IP Link.				C3P4	C2P4	C1P4	C0P4
		Byte n (M12)					C1P2	C1P4	C0P2	C0P4
	<b>Output</b>	Byte n (M8)					C7P4	C6P4	C5P4	C4P4
		Byte n (M12)					C3P2	C3P4	C2P2	C2P4

C... = Connector no., P... = Pin no.



**piconet® coupling module for PROFINET**  
**4 digital pnp inputs filter 3 ms**  
**4 digital outputs 0.5 A**

**Device types**

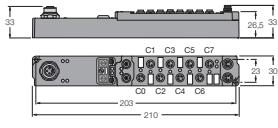
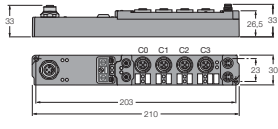
Dimensions	Type	Connection
	<b>6824478 SPNL-0404D-0003</b>	F120, F077, F079, F081
	<b>6824477 SPNL-0404D-0004</b>	F120, F117, F118, F081

3

**Connection**

F120 - Ethernet M12 x 1

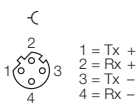

F117 - Input M12 x 1

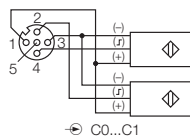

F118 - Output M12 x 1

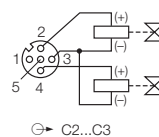

F077 - Input M8 x 1

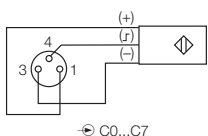

F079 - Output M8 x 1

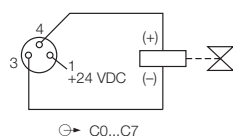

F081 - Voltage supply M8 x 1

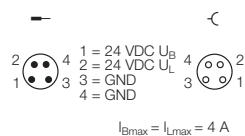

# piconet® – Extension modules

## piconet® – Extension modules for IP-Link

Page

### Digital modules

8 digital inputs, filter 0.2 ms or 3 ms	148
8 digital outputs, 0.5 A	152
8 digital outputs, 2 A ( $I_{\Sigma} = 4 \text{ A}$ )	154
8 digital outputs, 2 A ( $I_{\Sigma} = 12 \text{ A}$ )	156
16 digital outputs, 0.5 A ( $I_{\Sigma} = 4 \text{ A}$ )	158
4 digital inputs, filter 0.2 ms or 3 ms and 4 digital outputs, 0.5 A	160
4 digital inputs, filter 0.2 ms or 3 ms and 4 digital outputs, 2 A ( $I_{\Sigma} = 4 \text{ A}$ )	164
8 digital inputs, filter 3 ms and 8 digital outputs, 0.5 A	168
8 digital inputs, filter 3 ms and 8 digital outputs, 0.5 A, IP20	170

### Analogue modules

4 analogue differential inputs $\pm 10 \text{ V}$ , 16 bits	172
4 analogue differential inputs 0...20 mA, 16 bits	174
4 analogue inputs for Pt100 (RTD)	176
4 analogue inputs for thermoelements	178
4 analogue outputs, $\pm 10 \text{ V}$ , 16 bits	180
4 analogue outputs, 0...20 mA, 16 bits	182

### Technology modules

2-channel pulse width modulation, 24 VDC, 2.5 A	184
2-channel up/down counter, 24 VDC, 100 kHz	186
1-channel incremental encoder interface	188
1-channel serial interface RS232	190
1-channel serial interface 0...20 mA (TTY)	192
1-channel serial interface RS232/RS485	194
1-channel SSI encoder interface	196

### FESTO valve terminal

8 valve discs with max. 16 valve coils	198
--	-----

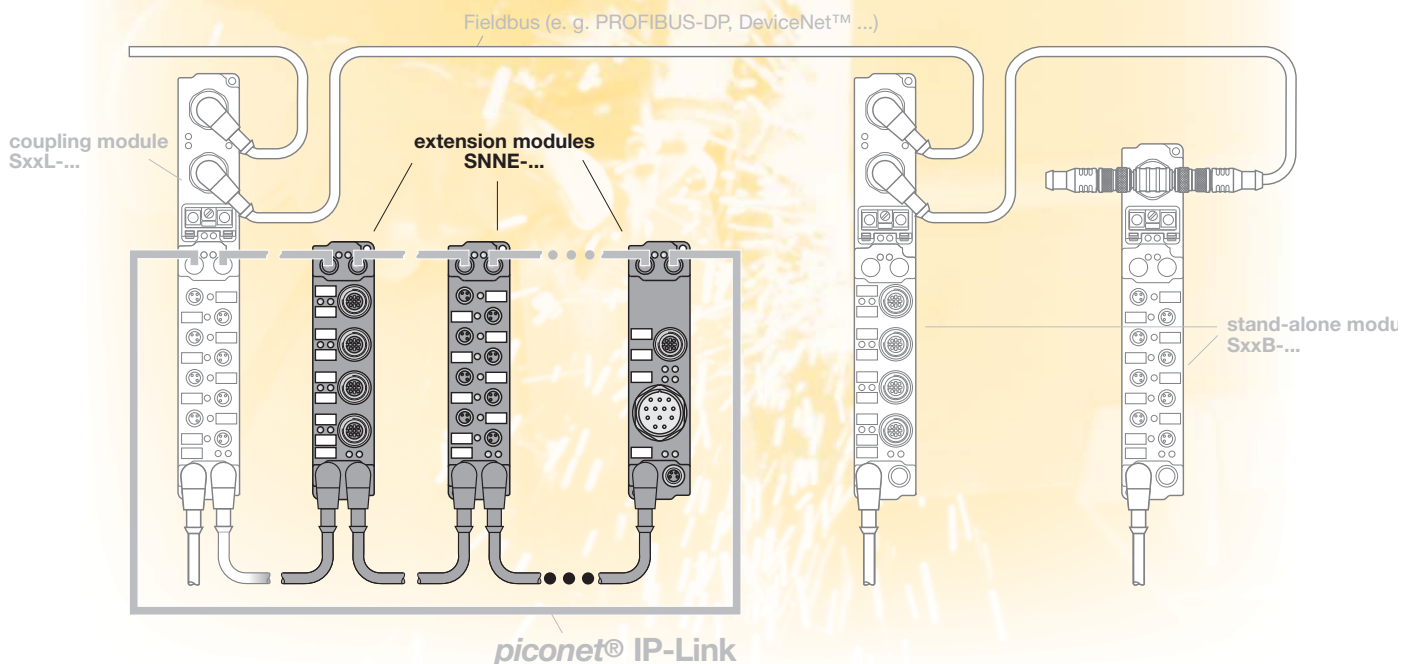

## ***piconet*<sup>®</sup> – Extension modules for IP-Link**

*piconet*<sup>®</sup> extension modules are equipped with a bus connector for the fibre-optic network IP-Link. The IP-Link allows connection and operation of up to 120 extension modules via a single coupling module.

The product spectrum comprises extension modules for the entire spectrum of I/O signals – ranging from standardised digital industrial signals up to analogue inputs and outputs. The family is complemented by a choice of technology modules, such as a pulse width modulator, an up/down counter and an incremental en-

coder as well as various serial interfaces. The coupling module collects the I/O data of the connected extension modules via the interference immune and fast (2 Mbps) IP-Link network.

The transmission time for 1,000 I/Os is approx. 1 ms – if less data are transferred the transmission time is even less. The maximum length of a fibre-optic cable is 15 m.

The robust IP67 housing is extremely compact, fully encapsulated and equipped throughout with metal connectors.

As a result, our *piconet*<sup>®</sup> modules are suited for application both in rough industrial environments as well as in space-critical applications in serial and special machine engineering.

Operating and load voltage are – as with all *piconet*<sup>®</sup> module types – fed separately. Alongside the “Power“ LED, each channel is assigned a “Status“ LED for switching status indications.

### ***piconet*<sup>®</sup> – Extension modules for IP-Link – general technical data**

#### **Adjustment**

Transmission rate automatic

#### **LED indications (module-specific)**

Status IP-Link or module (local errors)

- green LED flashing/ON – red LED OFF: receipt of error-free IP-Link protocols
- green LED flashing/red LED flashing: receipt of faulty IP-Link protocols (must not lead to a system error)
- green LED OFF/red LED flashing: receipt of faulty IP-Link protocols
- green LED OFF/red LED ON: no data transfer via the IP-Link or module error

Operating voltage  $U_B$  green: operational

Load voltage  $U_L$  green: operational

#### **Connections**

IP-Link brass, nickel-plated  
(2) IP-Link female connectors

Length of fibre-optic cable max. 15 m

Power supply depending on the respective module type

Inputs/outputs selectable: (8) M8 female connectors or (4) M12 female connectors

#### **Housing**

Material compact, fully encapsulated plastic housing  
PA6 (Polyamid)

Dimensions 126 x 30 x 26.5 mm (H x W x D)

Mounting via 2 through-holes,  $\varnothing$  3 mm

Mounting position any

Operating temperature (range) 0 °C to +55 °C (+32 °F to +131 °F)



Operating temperature (storage) -25 °C to +85 °C (-13 °F to +185 °F)

Degree of protection (IEC 60529/EN 60529) IP65, IP66, IP67

Vibration and shock testing according to IEC 68, part 2-6 / IEC 68, part 2-27

Electromagnetic capability (EMC) according to EN 50081-2/EN 50082-2

Weight approx. 120–200 g (depending on type)

Approvals  



**Please note:** further technical information is contained in the *piconet*<sup>®</sup> user manuals.

**piconet® extension module for IP link**  
**8 digital pnp inputs filter 3 ms**

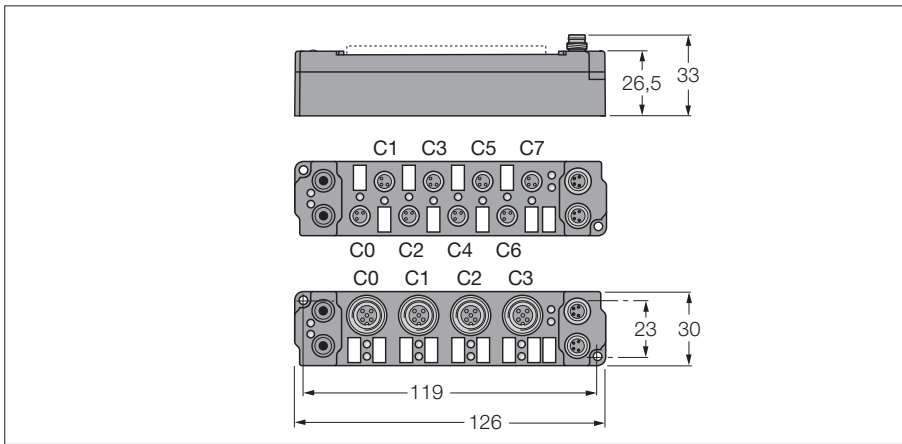

- 8 digital pnp inputs
- Input filter 3 ms
- Parameterisable functions
- Supported via I/O-ASSISTANT
- Direct connection to the fieldbus
- Fibre-glass reinforced PA6 housing
- Encapsulated module electronics
- Metal connector
- Degree of protection IP67

<b>Operating / load voltage</b>	20...29 VDC
Operating current	≤ 25 mA
<b>Fibre-optic length</b>	≤ 15 m
<b>Inputs</b>	
Number of channels	8 digital inputs acc. to EN 61131-2
Input voltage	20...29 VDC via operating voltage
Supply current	< 500 mA per channel, short-circuit proof
Low level signal voltage	-3...5 VDC (EN 61131-2, type 2)
High level signal voltage	11...30 VDC (EN 61131-2, type 2)
Input delay	3 ms
Max. input current	6 mA
<b>Operating temperature</b>	0 to 55 °C

**Data in process image**

		Bit 7	Bit 6	Bit 5	Bit 4	Bit 3	Bit 2	Bit 1	Bit 0	
PROFIBUS-DP coupling module: "Byte alignment" is disabled (default) and byte n has been used halfway. DeviceNet™, CANopen, INTERBUS, Ethernet coupling module: Byte n has been used halfway. Up to 8 bit user data are mapped.	<b>Output</b>	<b>Byte n (M8)</b>	C3P4	C2P4	C1P4	C0P4	Is used by the physically preceding bit-oriented extension module connected via the IP Link.			
		<b>Byte n (M12)</b>	C1P2	C1P4	C0P2	C0P4				
		<b>Byte n+1 (M8)</b>	Is used by the physically following bit-oriented extension module connected via the IP Link.				C7P4	C6P4	C5P4	C4P4
		<b>Byte n+1 (M12)</b>					C3P2	C3P4	C2P2	C2P4
PROFIBUS-DP coupling module: "Byte alignment" is disabled (default) and the previous byte has been completely used or "byte alignment" is active. DeviceNet™, CANopen, INTERBUS, Ethernet coupling module: The previous byte has been completely used. Up to 8 bit user data are mapped.	<b>Output</b>	<b>Byte n (M8)</b>	C7P4	C6P4	C5P4	C4P4	C3P4	C2P4	C1P4	C0P4
		<b>Byte n (M12)</b>	C3P2	C3P4	C2P2	C2P4	C1P2	C1P4	C0P2	C0P4
C... = Connector no. – P... = Pin no.										

**piconet® extension module for IP link**  
**8 digital pnp inputs filter 3 ms**

**Device types**

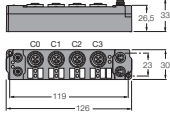
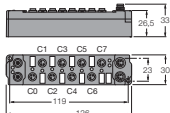
Dimensions	Type	Connection
	<b>6824203 SNNE-0800D-0004</b>	F117, F081
	<b>6824204 SNNE-0800D-0007</b>	F077, F081

**Connection**

F117 - Input M12 x 1

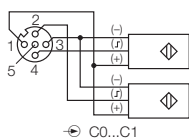

F081 - Voltage supply M8 x 1

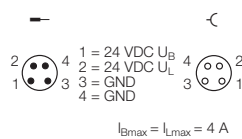

F077 - Input M8 x 1

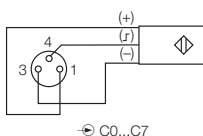

**piconet® extension module for IP link**  
**8 digital pnp inputs filter 0.2 ms**

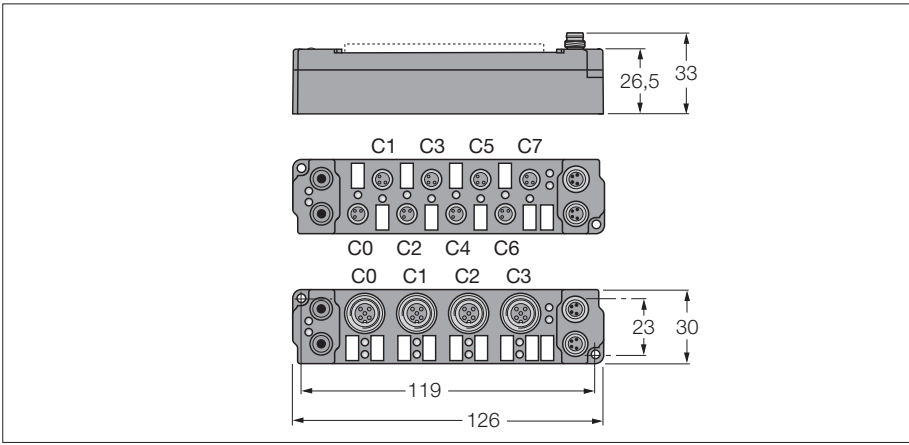

- 8 digital pnp inputs
- Input filter 0.2 ms
- Parameterisable functions
- Supported via I/O-ASSISTANT
- Direct connection to the fieldbus
- Fibre-glass reinforced PA6 housing
- Encapsulated module electronics
- Metal connector
- Degree of protection IP67

<b>Operating / load voltage</b>	20...29 VDC
Operating current	≤ 25 mA
<b>Fibre-optic length</b>	≤ 15 m
<b>Inputs</b>	
Number of channels	8 digital inputs acc. to EN 61131-2
Input voltage	20...29 VDC via operating voltage
Supply current	< 500 mA per channel, short-circuit proof
Low level signal voltage	-3...5 VDC (EN 61131-2, type 2)
High level signal voltage	11...30 VDC (EN 61131-2, type 2)
Input delay	0,2 ms
Max. input current	6 mA
<b>Operating temperature</b>	0 to 55 °C

**Data in process image**

		Bit 7	Bit 6	Bit 5	Bit 4	Bit 3	Bit 2	Bit 1	Bit 0	
PROFIBUS-DP coupling module: "Byte alignment" is disabled (default) and byte n has been used halfway. DeviceNet™, CANopen, INTERBUS, Ethernet coupling module: Byte n has been used halfway. Up to 8 bit user data are mapped.	<b>Output</b>	<b>Byte n (M8)</b>	C3P4	C2P4	C1P4	C0P4	Is used by the physically preceding bit-oriented extension module connected via the IP Link.			
		<b>Byte n (M12)</b>	C1P2	C1P4	C0P2	C0P4				
		<b>Byte n+1 (M8)</b>	Is used by the physically following bit-oriented extension module connected via the IP Link.				C7P4	C6P4	C5P4	C4P4
		<b>Byte n+1 (M12)</b>					C3P2	C3P4	C2P2	C2P4
PROFIBUS-DP coupling module: "Byte alignment" is disabled (default) and the previous byte has been completely used or "byte alignment" is active. DeviceNet™, CANopen, INTERBUS, Ethernet coupling module: The previous byte has been completely used. Up to 8 bit user data are mapped.	<b>Output</b>	<b>Byte n (M8)</b>	C7P4	C6P4	C5P4	C4P4	C3P4	C2P4	C1P4	C0P4
		<b>Byte n (M12)</b>	C3P2	C3P4	C2P2	C2P4	C1P2	C1P4	C0P2	C0P4
C... = Connector no. – P... = Pin no.										

**piconet® extension module for IP link**  
**8 digital pnp inputs filter 0.2 ms**

**Device types**

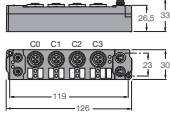
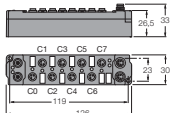
Dimensions	Type	Connection
	<b>6824202 SNNE-0800D-0002</b>	F117, F081
	<b>6824206 SNNE-0800D-0008</b>	F077, F081

**Connection**

F117 - Input M12 x 1

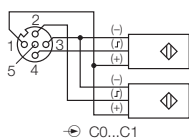

F081 - Voltage supply M8 x 1

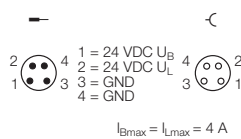

F077 - Input M8 x 1

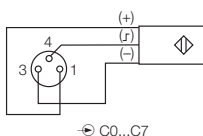

**piconet® extension module for IP link**  
**8 digital outputs 0.5 A**

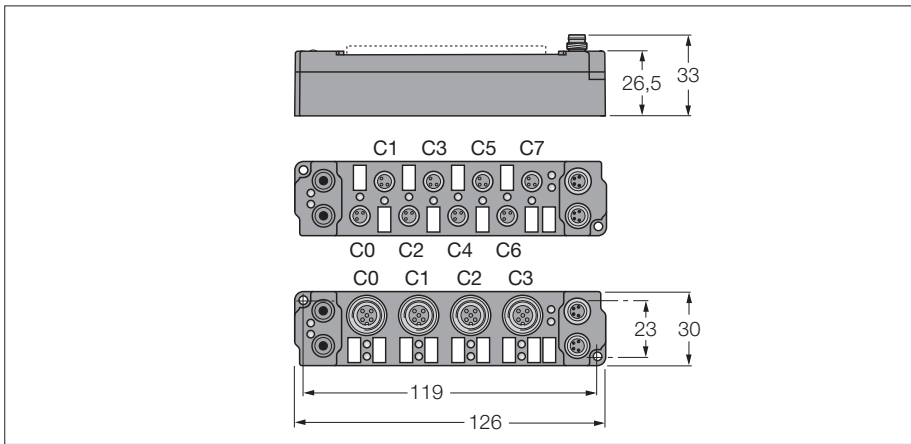

- 8 digital outputs 0.5 A
- Parameterisable functions
- Supported via I/O-ASSISTANT
- Direct connection to the fieldbus
- Fibre-glass reinforced PA6 housing
- Encapsulated module electronics
- Metal connector
- Degree of protection IP67

<b>Operating / load voltage</b>	20...29 VDC
Operating current	≤ 25 mA
<b>Fibre-optic length</b>	≤ 15 m
<b>Outputs</b>	
Number of channels	8 digital outputs acc. to EN 61131-2
Output voltage	20...29 VDC from load voltage
Output current per channel	0.5 A, short-circuit proof
Load type	resistive, inductive, lamp load
Switching frequency	≤ 500 Hz
Simultaneity factor	1
<b>Operating temperature</b>	0 to 55 °C

**Data in process image**

		Bit 7	Bit 6	Bit 5	Bit 4	Bit 3	Bit 2	Bit 1	Bit 0	
PROFIBUS-DP coupling module: "Byte alignment" is disabled (default) and byte n has been used halfway. DeviceNet™, CANopen, INTERBUS, Ethernet coupling module: Byte n has been used halfway. Up to 8 bit user data are mapped.	<b>Output</b>	<b>Byte n (M8)</b>	C3P4	C2P4	C1P4	C0P4	Is used by the physically preceding bit-oriented extension module connected via the IP Link.			
		<b>Byte n (M12)</b>	C1P2	C1P4	C0P2	C0P4				
		<b>Byte n+1 (M8)</b>	Is used by the physically following bit-oriented extension module connected via the IP Link.				C7P4	C6P4	C5P4	C4P4
		<b>Byte n+1 (M12)</b>					C3P2	C3P4	C2P2	C2P4
PROFIBUS-DP coupling module: "Byte alignment" is disabled (default) and the previous byte has been completely used or "byte alignment" is active. DeviceNet™, CANopen, INTERBUS, Ethernet coupling module: The previous byte has been completely used. Up to 8 bit user data are mapped.	<b>Output</b>	<b>Byte n (M8)</b>	C7P4	C6P4	C5P4	C4P4	C3P4	C2P4	C1P4	C0P4
		<b>Byte n (M12)</b>	C3P2	C3P4	C2P2	C2P4	C1P2	C1P4	C0P2	C0P4
C... = Connector no. – P... = Pin no.										



**piconet® extension module for IP link**  
**8 digital outputs 0.5 A**

**Device types**

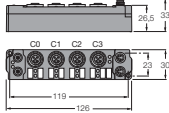
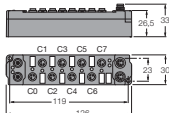
Dimensions	Type	Connection
	<b>6824178 SNNE-0008D-0001</b>	F118, F081
	<b>6824185 SNNE-0008D-0006</b>	F079, F081

**Connection**

F118 - Output M12 x 1

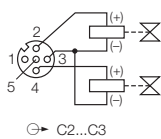

F081 - Voltage supply M8 x 1

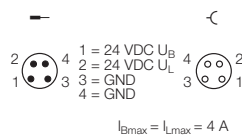

F079 - Output M8 x 1

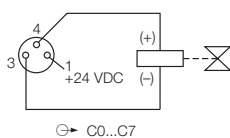

**piconet® extension module for IP link**  
**8 digital outputs 2 A ( $\Sigma$  4 A)**

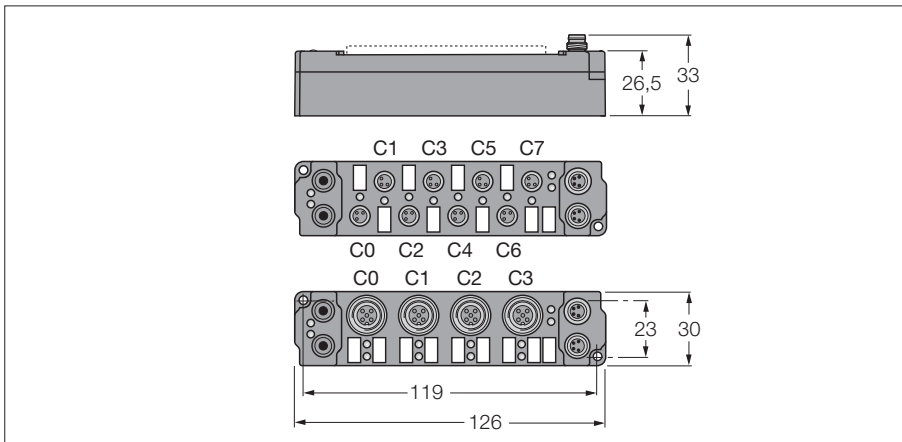

- 8 digital outputs 2 A
- Parameterisable functions
- Supported via I/O-ASSISTANT
- Direct connection to the fieldbus
- Fibre-glass reinforced PA6 housing
- Encapsulated module electronics
- Metal connector
- Degree of protection IP67

<b>Operating / load voltage</b>	20...29 VDC
Operating current	≤ 25 mA
<b>Fibre-optic length</b>	≤ 15 m
<b>Outputs</b>	
Number of channels	8 digital outputs acc. to EN 61131-2
Output voltage	20...29 VDC from load voltage
Output current per channel	2 A ( $\Sigma$ 4 A), short-circuit proof
Load type	resistive, inductive, lamp load
Switching frequency	≤ 500 Hz
Simultaneity factor	0.25
<b>Operating temperature</b>	0 to 55 °C

**Data in process image**

		Bit 7	Bit 6	Bit 5	Bit 4	Bit 3	Bit 2	Bit 1	Bit 0	
PROFIBUS-DP coupling module: "Byte alignment" is disabled (default) and byte n has been used halfway. DeviceNet™, CANopen, INTERBUS, Ethernet coupling module: Byte n has been used halfway. Up to 8 bit user data are mapped.	<b>Output</b>	<b>Byte n (M8)</b>	C3P4	C2P4	C1P4	C0P4	Is used by the physically preceding bit-oriented extension module connected via the IP Link.			
		<b>Byte n (M12)</b>	C1P2	C1P4	C0P2	C0P4				
		<b>Byte n+1 (M8)</b>	Is used by the physically following bit-oriented extension module connected via the IP Link.				C7P4	C6P4	C5P4	C4P4
		<b>Byte n+1 (M12)</b>					C3P2	C3P4	C2P2	C2P4
PROFIBUS-DP coupling module: "Byte alignment" is disabled (default) and the previous byte has been completely used or "byte alignment" is active. DeviceNet™, CANopen, INTERBUS, Ethernet coupling module: The previous byte has been completely used. Up to 8 bit user data are mapped.	<b>Output</b>	<b>Byte n (M8)</b>	C7P4	C6P4	C5P4	C4P4	C3P4	C2P4	C1P4	C0P4
		<b>Byte n (M12)</b>	C3P2	C3P4	C2P2	C2P4	C1P2	C1P4	C0P2	C0P4
C... = Connector no. – P... = Pin no.										

**piconet® extension module for IP link**  
**8 digital outputs 2 A ( $\Sigma$  4 A)**

**Device types**

Dimensions	Type	Connection
	<b>6824179 SNNE-0008D-0002</b>	F079, F081
	<b>6824181 SNNE-0008D-0003</b>	F118, F081

**Connection**

F079 - Output M8 x 1

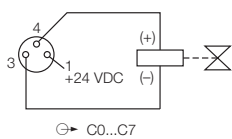

F081 - Voltage supply M8 x 1

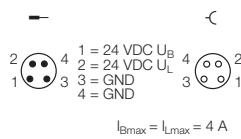

F118 - Output M12 x 1

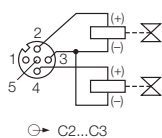

**piconet® extension module for IP link**  
**8 digital outputs 2 A ( $\Sigma$  12 A)**

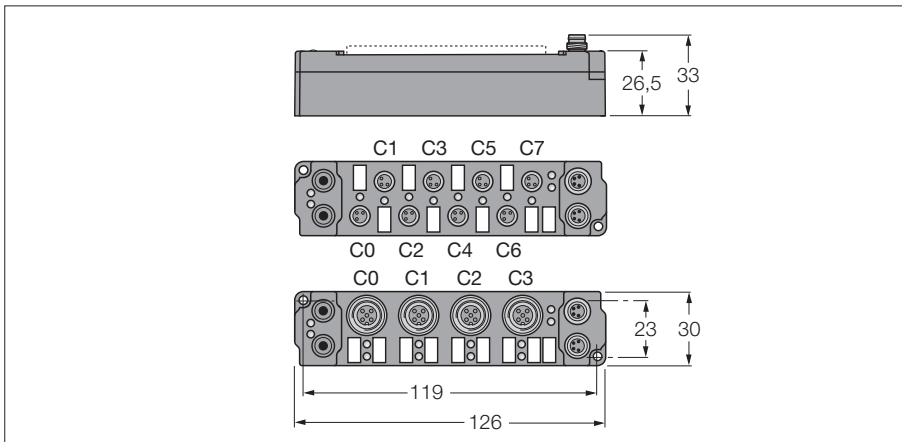

- 8 digital outputs 2 A
- Parameterisable functions
- Supported via I/O-ASSISTANT
- Direct connection to the fieldbus
- Fibre-glass reinforced PA6 housing
- Encapsulated module electronics
- Metal connector
- Degree of protection IP67

<b>Operating / load voltage</b>	20...29 VDC
Operating current	≤ 25 mA
<b>Fibre-optic length</b>	≤ 15 m
<b>Outputs</b>	
Number of channels	8 digital outputs acc. to EN 61131-2
Output voltage	20...29 VDC from load voltage
Output current per channel	2 A ( $\Sigma$ 12 A), short-circuit proof
Load type	resistive, inductive, lamp load
Switching frequency	≤ 500 Hz
Simultaneity factor	0.75
<b>Operating temperature</b>	0 to 55 °C

**Data in process image**

		Bit 7	Bit 6	Bit 5	Bit 4	Bit 3	Bit 2	Bit 1	Bit 0	
PROFIBUS-DP coupling module: "Byte alignment" is disabled (default) and byte n has been used halfway. DeviceNet™, CANopen, INTERBUS, Ethernet coupling module: Byte n has been used halfway. Up to 8 bit user data are mapped.	<b>Output</b>	<b>Byte n (M8)</b>	C3P4	C2P4	C1P4	C0P4	Is used by the physically preceding bit-oriented extension module connected via the IP Link.			
		<b>Byte n (M12)</b>	C1P2	C1P4	C0P2	C0P4				
		<b>Byte n+1 (M8)</b>	Is used by the physically following bit-oriented extension module connected via the IP Link.				C7P4	C6P4	C5P4	C4P4
		<b>Byte n+1 (M12)</b>					C3P2	C3P4	C2P2	C2P4
PROFIBUS-DP coupling module: "Byte alignment" is disabled (default) and the previous byte has been completely used or "byte alignment" is active. DeviceNet™, CANopen, INTERBUS, Ethernet coupling module: The previous byte has been completely used. Up to 8 bit user data are mapped.	<b>Output</b>	<b>Byte n (M8)</b>	C7P4	C6P4	C5P4	C4P4	C3P4	C2P4	C1P4	C0P4
		<b>Byte n (M12)</b>	C3P2	C3P4	C2P2	C2P4	C1P2	C1P4	C0P2	C0P4
C... = Connector no. – P... = Pin no.										

**piconet® extension module for IP link**  
**8 digital outputs 2 A (Σ 12 A)**

**Device types**

Dimensions	Type	Connection
	<b>6824182 SNNE-0008D-0004</b>	F079, F082
	<b>6824184 SNNE-0008D-0005</b>	F118, F082

**Connection**

F079 - Output M8 x 1

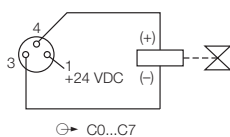

F082 - Voltage supply M8 x 1

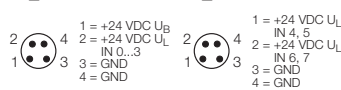

F118 - Output M12 x 1

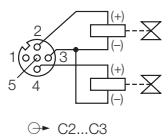

**piconet® extension module for IP link**  
**8 digital outputs 0.5 A ( $\Sigma$  4 A)**

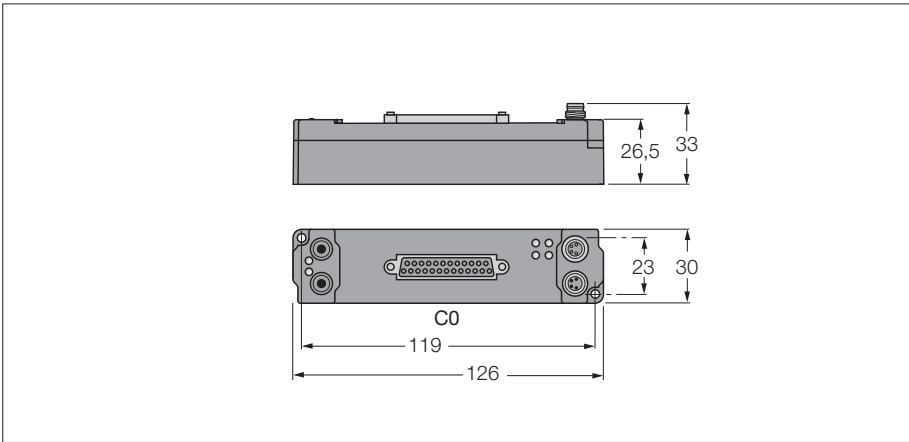

- 16 digital outputs 0.5 A
- Parameterisable functions
- Supported via I/O-ASSISTANT
- Direct connection to the fieldbus
- Fibre-glass reinforced PA6 housing
- Encapsulated module electronics
- Metal connector
- Degree of protection IP67

<b>Operating / load voltage</b>	20...29 VDC
Operating current	≤ 25 mA
<b>Fibre-optic length</b>	≤ 15 m
<b>Outputs</b>	
Number of channels	16 digital outputs acc. to EN 61131-2
Output voltage	20...29 VDC from load voltage
Output current per channel	0.5 A ( $\Sigma$ 4 A), short-circuit proof
Load type	resistive, inductive, lamp load
Switching frequency	≤ 500 Hz
Simultaneity factor	0.5
<b>Operating temperature</b>	0 to 55 °C

**Data in process image**

		Bit 7	Bit 6	Bit 5	Bit 4	Bit 3	Bit 2	Bit 1	Bit 0	
PROFIBUS-DP coupling module: "Byte alignment" is disabled (default) and byte n has been used halfway. DeviceNet™, CANopen, INTERBUS, Ethernet coupling module: Byte n has been used halfway. Up to 8 bit user data are mapped.	<b>Output</b>	<b>Byte n</b>	C0P4	C0P3	C0P2	C0P1	Is used by the physically preceding bit-oriented extension module connected via the IP Link.			
		<b>Byte n+1</b>	C0P12	C0P11	C0P10	C0P9	C0P8	C0P7	C0P6	C0P5
		<b>Byte n+2</b>	Is used by the physically following bit-oriented extension module connected via the IP Link.				C0P16	C0P15	C0P14	C0P13
PROFIBUS-DP coupling module: "Byte alignment" is disabled (default) and the previous byte has been completely used or "byte alignment" is active. DeviceNet™, CANopen, INTERBUS, Ethernet coupling module: The previous byte has been completely used. Up to 8 bit user data are mapped.	<b>Output</b>	<b>Byte n</b>	C0P8	C0P7	C0P6	C0P5	C0P4	C0P3	C0P2	C0P1
		<b>Byte n+1</b>	C0P16	C0P15	C0P14	C0P13	C0P12	C0P11	C0P10	C0P9
C... = Connector no. – P... = Pin no.										

**piconet® extension module for IP link**  
**8 digital outputs 0.5 A ( $\Sigma$  4 A)**

**Device types**

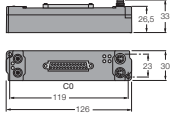
Dimensions	Type	Connection
	6824476 SNNE-0016D-0002	F121, F081

**Connection**

F121 - Sub-D output

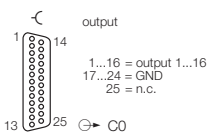

F081 - Voltage supply M8 x 1



**piconet® extension module for IP link**  
**4 digital pnp inputs filter 3 ms**  
**4 digital outputs 0.5 A**

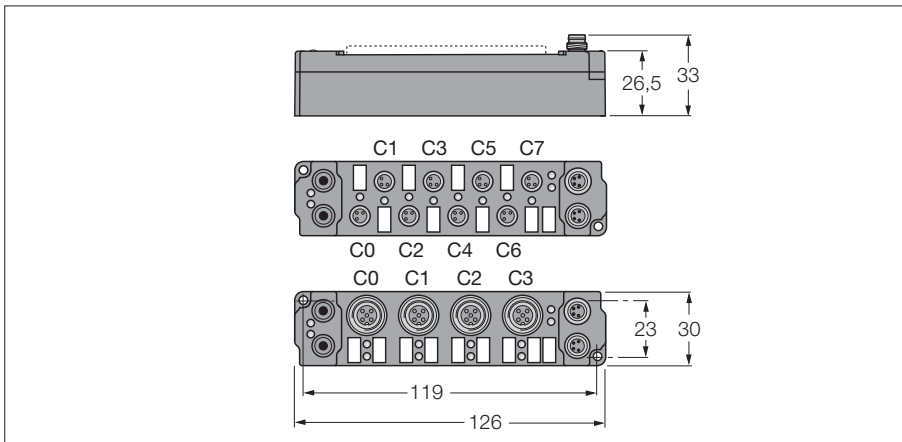

- 4 digital pnp inputs
- 4 digital outputs 0.5 A
- Input filter 3 ms
- Parameterisable functions
- Supported via I/O-ASSISTANT
- Direct connection to the fieldbus
- Fibre-glass reinforced PA6 housing
- Encapsulated module electronics
- Metal connector
- Degree of protection IP67

<b>Operating / load voltage</b>	20...29 VDC
Operating current	≤ 25 mA
<b>Fibre-optic length</b>	≤ 15 m
<b>Inputs</b>	
Number of channels	4 digital inputs acc. to EN 61131-2
Input voltage	20...29 VDC via operating voltage
Supply current	< 500 mA per channel, short-circuit proof
Low level signal voltage	-3...5 VDC (EN 61131-2, type 2)
High level signal voltage	11...30 VDC (EN 61131-2, type 2)
Input delay	3 ms
Max. input current	6 mA
<b>Outputs</b>	
Number of channels	4 digital outputs acc. to EN 61131-2
Output voltage	20...29 VDC from load voltage
Output current per channel	0.5 A, short-circuit proof
Load type	resistive, inductive, lamp load
Switching frequency	≤ 500 Hz
Simultaneity factor	1
<b>Operating temperature</b>	0 to 55 °C

**Data in process image**

			Bit 7	Bit 6	Bit 5	Bit 4	Bit 3	Bit 2	Bit 1	Bit 0
PROFIBUS-DP coupling module: "Byte alignment" is disabled (default) and the previous byte has been completely used or "byte alignment" is activated. DeviceNet™, CANopen, INTERBUS, Ethernet coupling module: The previous byte has been completely used. Up to 4 bit input data and output data each are mapped.	<b>Input</b>	Byte n (M8)	Is used by the physically following bit-oriented extension module connected via the IP Link.				C3P4	C2P4	C1P4	C0P4
		Byte n (M12)					C1P2	C1P4	C0P2	C0P4
	<b>Output</b>	Byte n (M8)					C7P4	C6P4	C5P4	C4P4
		Byte n (M12)					C3P2	C3P4	C2P2	C2P4
PROFIBUS-DP coupling module: "Byte alignment" is disabled (default) and the previous byte has been used halfway. DeviceNet™, CANopen, INTERBUS, Ethernet coupling module: Byte n has been used halfway. Up to 4 bit input data and output data each are mapped.	<b>Input</b>	Byte n (M8)	C3P4	C2P4	C1P4	C0P4	Is used by the physically preceeding bit-oriented extension module connected via the IP Link.			
		Byte n (M12)	C1P2	C1P4	C0P2	C0P4				
	<b>Output</b>	Byte n (M8)	C7P4	C6P4	C5P4	C4P4				
		Byte n (M12)	C3P2	C3P4	C2P2	C2P4				
PROFIBUS-DP coupling module: "Byte alignment" is activated. Up to 8 bit input data and output data each are mapped.	<b>Input</b>	Byte n (M8)	idle	idle	idle	idle	C3P4	C2P4	C1P4	C0P4
		Byte n (M12)	idle	idle	idle	idle	C1P2	C1P4	C0P2	C0P4
	<b>Output</b>	Byte n (M8)	C7P4	C6P4	C5P4	C4P4	idle	idle	idle	idle
		Byte n (M12)	C3P2	C3P4	C2P2	C2P4	idle	idle	idle	idle

C... = Connector no. – P... = Pin no.



**piconet® extension module for IP link**  
**4 digital pnp inputs filter 3 ms**  
**4 digital outputs 0.5 A**

**Device types**

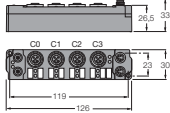
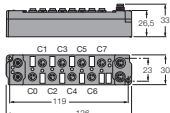
Dimensions	Type	Connection
	<b>6824193 SNNE-0404D-0004</b>	F117, F118, F081
	<b>6824191 SNNE-0404D-0003</b>	F077, F079, F081

**3**

**Connection**

F117 - Input M12 x 1

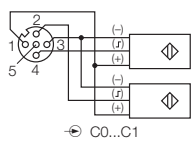

F118 - Output M12 x 1

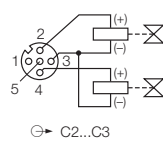

F081 - Voltage supply M8 x 1

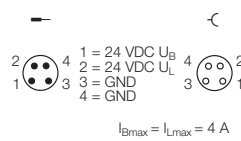

F077 - Input M8 x 1

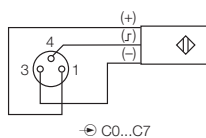

F079 - Output M8 x 1

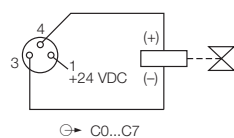

**piconet® extension module for IP link**  
**4 digital pnp inputs filter 0.2 ms**  
**4 digital outputs 0.5 A**

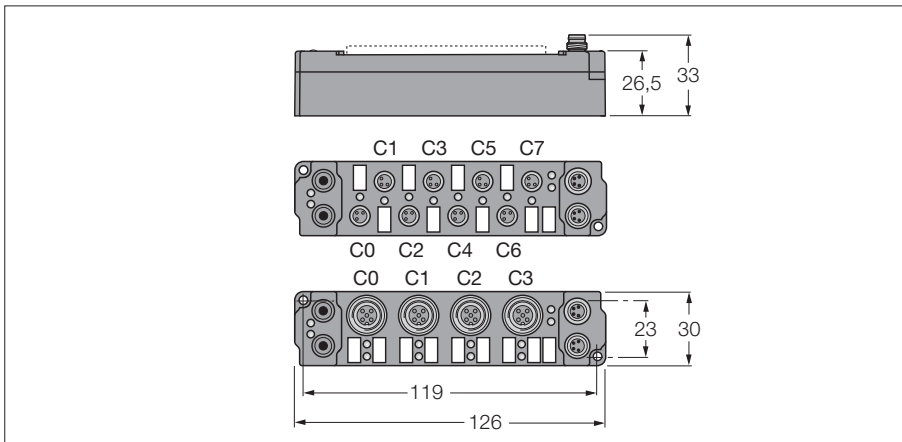

- 4 digital pnp inputs
- 4 digital outputs 0.5 A
- Input filter 0.2 ms
- Parameterisable functions
- Supported via I/O-ASSISTANT
- Direct connection to the fieldbus
- Fibre-glass reinforced PA6 housing
- Encapsulated module electronics
- Metal connector
- Degree of protection IP67

<b>Operating / load voltage</b>	20...29 VDC
Operating current	≤ 25 mA
<b>Fibre-optic length</b>	≤ 15 m
<b>Inputs</b>	
Number of channels	4 digital inputs acc. to EN 61131-2
Input voltage	20...29 VDC via operating voltage
Supply current	< 500 mA per channel, short-circuit proof
Low level signal voltage	-3...5 VDC (EN 61131-2, type 2)
High level signal voltage	11...30 VDC (EN 61131-2, type 2)
Input delay	0,2 ms
Max. input current	6 mA
<b>Outputs</b>	
Number of channels	4 digital outputs acc. to EN 61131-2
Output voltage	20...29 VDC from load voltage
Output current per channel	0.5 A, short-circuit proof
Load type	resistive, inductive, lamp load
Switching frequency	≤ 500 Hz
Simultaneity factor	1
<b>Operating temperature</b>	0 to 55 °C

**Data in process image**

			Bit 7	Bit 6	Bit 5	Bit 4	Bit 3	Bit 2	Bit 1	Bit 0	
PROFIBUS-DP coupling module: "Byte alignment" is disabled (default) and the previous byte has been completely used or "byte alignment" is activated. DeviceNet™, CANopen, INTERBUS, Ethernet coupling module: The previous byte has been completely used. Up to 4 bit input data and output data each are mapped.	<b>Input</b>	Byte n (M8)	Is used by the physically following bit-oriented extension module connected via the IP Link.				C3P4	C2P4	C1P4	C0P4	
		Byte n (M12)					C1P2	C1P4	C0P2	C0P4	
	<b>Output</b>	Byte n (M8)					C7P4	C6P4	C5P4	C4P4	
		Byte n (M12)					C3P2	C3P4	C2P2	C2P4	
PROFIBUS-DP coupling module: "Byte alignment" is disabled (default) and the previous byte has been used halfway. DeviceNet™, CANopen, INTERBUS, Ethernet coupling module: Byte n has been used halfway. Up to 4 bit input data and output data each are mapped.	<b>Input</b>	Byte n (M8)	C3P4	C2P4	C1P4	C0P4		Is used by the physically preceeding bit-oriented extension module connected via the IP Link.			
		Byte n (M12)	C1P2	C1P4	C0P2	C0P4					
	<b>Output</b>	Byte n (M8)	C7P4	C6P4	C5P4	C4P4					
		Byte n (M12)	C3P2	C3P4	C2P2	C2P4					
PROFIBUS-DP coupling module: "Byte alignment" is activated. Up to 8 bit input data and output data each are mapped.	<b>Input</b>	Byte n (M8)	idle	idle	idle	idle	C3P4	C2P4	C1P4	C0P4	
		Byte n (M12)	idle	idle	idle	idle	C1P2	C1P4	C0P2	C0P4	
	<b>Output</b>	Byte n (M8)	C7P4	C6P4	C5P4	C4P4		idle	idle	idle	idle
		Byte n (M12)	C3P2	C3P4	C2P2	C2P4		idle	idle	idle	idle

C... = Connector no. – P... = Pin no.

**piconet® extension module for IP link**  
**4 digital pnp inputs filter 0.2 ms**  
**4 digital outputs 0.5 A**

**Device types**

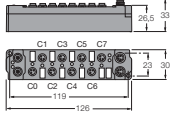
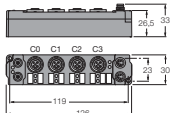
Dimensions	Type	Connection
	<b>6824188 SNNE-0404D-0001</b>	F077, F079, F081
	<b>6824190 SNNE-0404D-0002</b>	F117, F118, F081

**Connection**

F077 - Input M8 x 1

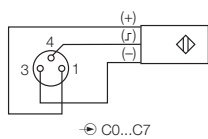

F079 - Output M8 x 1

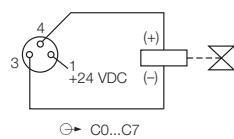

F081 - Voltage supply M8 x 1

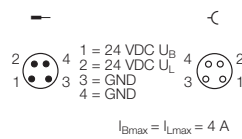

F117 - Input M12 x 1

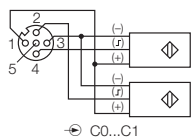

F118 - Output M12 x 1

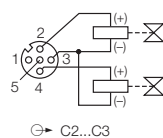

**piconet® extension module for IP link**  
**4 digital pnp inputs filter 3 ms**  
**4 digital outputs 2 A**

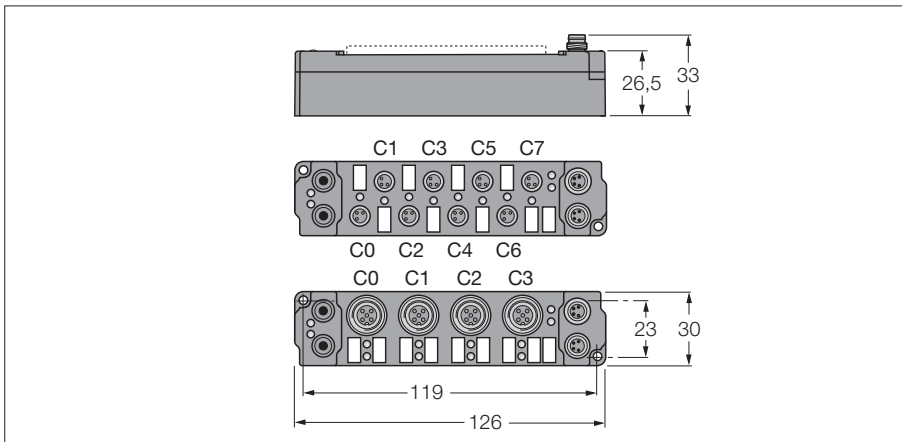

- 4 digital pnp inputs
- 4 digital outputs 2 A
- Input filter 3 ms
- Parameterisable functions
- Supported via I/O-ASSISTANT
- Direct connection to the fieldbus
- Fibre-glass reinforced PA6 housing
- Encapsulated module electronics
- Metal connector
- Degree of protection IP67

<b>Operating / load voltage</b>	20...29 VDC
Operating current	≤ 25 mA
<b>Fibre-optic length</b>	≤ 15 m
<b>Inputs</b>	
Number of channels	4 digital inputs acc. to EN 61131-2
Input voltage	20...29 VDC via operating voltage
Supply current	< 500 mA per channel, short-circuit proof
Low level signal voltage	-3...5 VDC (EN 61131-2, type 2)
High level signal voltage	11...30 VDC (EN 61131-2, type 2)
Input delay	3 ms
Max. input current	6 mA
<b>Outputs</b>	
Number of channels	4 digital outputs acc. to EN 61131-2
Output voltage	20...29 VDC from load voltage
Output current per channel	2 A (Σ 4 A), short-circuit proof
Load type	resistive, inductive, lamp load
Switching frequency	≤ 500 Hz
Simultaneity factor	0.5
<b>Operating temperature</b>	0 to 55 °C

**Data in process image**

			Bit 7	Bit 6	Bit 5	Bit 4	Bit 3	Bit 2	Bit 1	Bit 0
PROFIBUS-DP coupling module: "Byte alignment" is disabled (default) and the previous byte has been completely used or "byte alignment" is activated. DeviceNet™, CANopen, INTERBUS, Ethernet coupling module: The previous byte has been completely used. Up to 4 bit input data and output data each are mapped.	<b>Input</b>	Byte n (M8)	Is used by the physically following bit-oriented extension module connected via the IP Link.				C3P4	C2P4	C1P4	C0P4
		Byte n (M12)					C1P2	C1P4	C0P2	C0P4
	<b>Output</b>	Byte n (M8)					C7P4	C6P4	C5P4	C4P4
		Byte n (M12)					C3P2	C3P4	C2P2	C2P4
PROFIBUS-DP coupling module: "Byte alignment" is disabled (default) and the previous byte has been used halfway. DeviceNet™, CANopen, INTERBUS, Ethernet coupling module: Byte n has been used halfway. Up to 4 bit input data and output data each are mapped.	<b>Input</b>	Byte n (M8)	C3P4	C2P4	C1P4	C0P4	Is used by the physically preceeding bit-oriented extension module connected via the IP Link.			
		Byte n (M12)	C1P2	C1P4	C0P2	C0P4				
	<b>Output</b>	Byte n (M8)	C7P4	C6P4	C5P4	C4P4				
		Byte n (M12)	C3P2	C3P4	C2P2	C2P4				
PROFIBUS-DP coupling module: "Byte alignment" is activated. Up to 8 bit input data and output data each are mapped.	<b>Input</b>	Byte n (M8)	idle	idle	idle	idle	C3P4	C2P4	C1P4	C0P4
		Byte n (M12)	idle	idle	idle	idle	C1P2	C1P4	C0P2	C0P4
	<b>Output</b>	Byte n (M8)	C7P4	C6P4	C5P4	C4P4	idle	idle	idle	idle
		Byte n (M12)	C3P2	C3P4	C2P2	C2P4	idle	idle	idle	idle

C... = Connector no. – P... = Pin no.

**piconet® extension module for IP link**  
**4 digital pnp inputs filter 3 ms**  
**4 digital outputs 2 A**

**Device types**

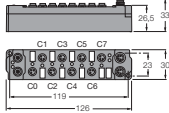
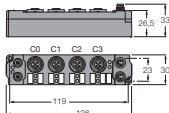
Dimensions	Type	Connection
	<b>6824197 SNNE-0404D-0007</b>	F077, F079, F081
	<b>6824199 SNNE-0404D-0008</b>	F117, F118, F081

**3**

**Connection**

F077 - Input M8 x 1

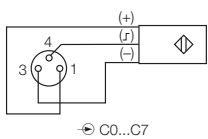

F079 - Output M8 x 1

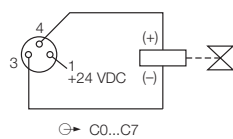

F081 - Voltage supply M8 x 1

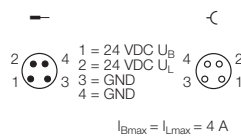

F117 - Input M12 x 1

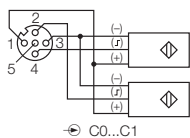

F118 - Output M12 x 1

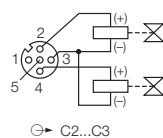

**piconet® extension module for IP link**  
**4 digital pnp inputs filter 0.2 ms**  
**4 digital outputs 2 A**

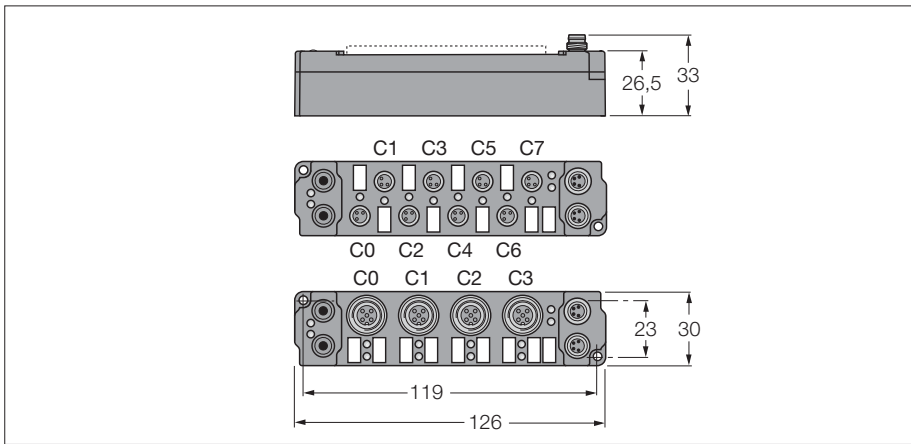

- 4 digital pnp inputs
- 4 digital outputs 2 A
- Input filter 0.2 ms
- Parameterisable functions
- Supported via I/O-ASSISTANT
- Direct connection to the fieldbus
- Fibre-glass reinforced PA6 housing
- Encapsulated module electronics
- Metal connector
- Degree of protection IP67

<b>Operating / load voltage</b>	20...29 VDC
Operating current	≤ 25 mA
<b>Fibre-optic length</b>	≤ 15 m
<b>Inputs</b>	
Number of channels	4 digital inputs acc. to EN 61131-2
Input voltage	20...29 VDC via operating voltage
Supply current	< 500 mA per channel, short-circuit proof
Low level signal voltage	-3...5 VDC (EN 61131-2, type 2)
High level signal voltage	11...30 VDC (EN 61131-2, type 2)
Input delay	0,2 ms
Max. input current	6 mA
<b>Outputs</b>	
Number of channels	4 digital outputs acc. to EN 61131-2
Output voltage	20...29 VDC from load voltage
Output current per channel	2 A (Σ 4 A), short-circuit proof
Load type	resistive, inductive, lamp load
Switching frequency	≤ 500 Hz
Simultaneity factor	0.5
<b>Operating temperature</b>	0 to 55 °C

**Data in process image**

			Bit 7	Bit 6	Bit 5	Bit 4	Bit 3	Bit 2	Bit 1	Bit 0
PROFIBUS-DP coupling module: "Byte alignment" is disabled (default) and the previous byte has been completely used or "byte alignment" is activated. DeviceNet™, CANopen, INTERBUS, Ethernet coupling module: The previous byte has been completely used. Up to 4 bit input data and output data each are mapped.	<b>Input</b>	Byte n (M8)	Is used by the physically following bit-oriented extension module connected via the IP Link.				C3P4	C2P4	C1P4	C0P4
		Byte n (M12)					C1P2	C1P4	C0P2	C0P4
	<b>Output</b>	Byte n (M8)					C7P4	C6P4	C5P4	C4P4
		Byte n (M12)					C3P2	C3P4	C2P2	C2P4
PROFIBUS-DP coupling module: "Byte alignment" is disabled (default) and the previous byte has been used halfway. DeviceNet™, CANopen, INTERBUS, Ethernet coupling module: Byte n has been used halfway. Up to 4 bit input data and output data each are mapped.	<b>Input</b>	Byte n (M8)	C3P4	C2P4	C1P4	C0P4	Is used by the physically preceeding bit-oriented extension module connected via the IP Link.			
		Byte n (M12)	C1P2	C1P4	C0P2	C0P4				
	<b>Output</b>	Byte n (M8)	C7P4	C6P4	C5P4	C4P4				
		Byte n (M12)	C3P2	C3P4	C2P2	C2P4				
PROFIBUS-DP coupling module: "Byte alignment" is activated. Up to 8 bit input data and output data each are mapped.	<b>Input</b>	Byte n (M8)	idle	idle	idle	idle	C3P4	C2P4	C1P4	C0P4
		Byte n (M12)	idle	idle	idle	idle	C1P2	C1P4	C0P2	C0P4
	<b>Output</b>	Byte n (M8)	C7P4	C6P4	C5P4	C4P4	idle	idle	idle	idle
		Byte n (M12)	C3P2	C3P4	C2P2	C2P4	idle	idle	idle	idle

C... = Connector no. – P... = Pin no.

**piconet® extension module for IP link**  
**4 digital pnp inputs filter 0.2 ms**  
**4 digital outputs 2 A**

**Device types**

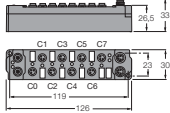
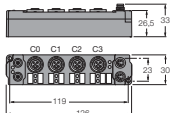
Dimensions	Type	Connection
	<b>6824194 SNNE-0404D-0005</b>	F077, F079, F081
	<b>6824196 SNNE-0404D-0006</b>	F117, F118, F081

**3**

**Connection**

F077 - Input M8 x 1

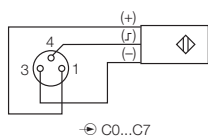

F079 - Output M8 x 1

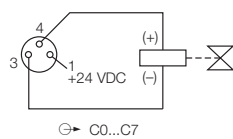

F081 - Voltage supply M8 x 1

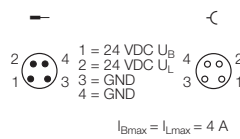

F117 - Input M12 x 1

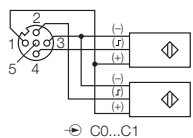

F118 - Output M12 x 1

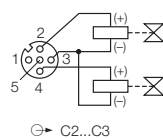

**piconet® extension module for IP link**  
**8 digital pnp inputs filter 3 ms**  
**8 digital outputs 0.5 A**

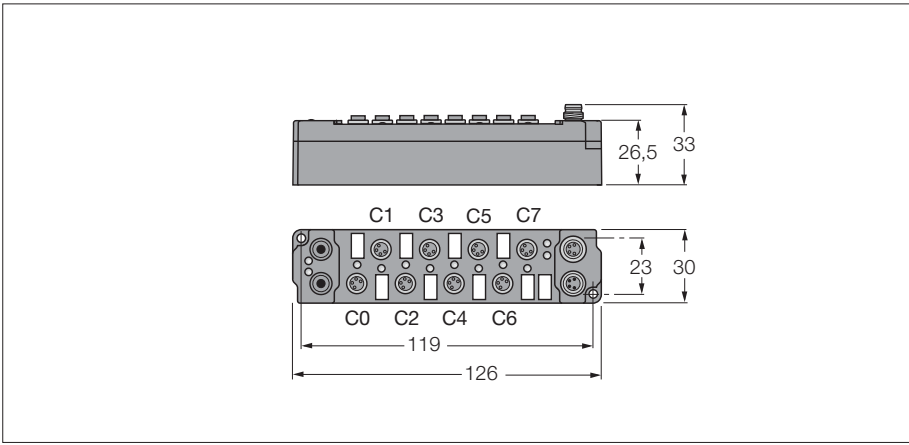

- 8 digital pnp inputs
- 8 digital outputs 0.5 A
- Input filter 3 ms
- Parameterisable functions
- Supported via I/O-ASSISTANT
- Direct connection to the fieldbus
- Fibre-glass reinforced PA6 housing
- Encapsulated module electronics
- Metal connector
- Degree of protection IP67

<b>Operating / load voltage</b>	20...29 VDC
Operating current	≤ 25 mA
<b>Fibre-optic length</b>	≤ 15 m
<b>Inputs</b>	
Number of channels	8 digital inputs acc. to EN 61131-2
Input voltage	20...29 VDC via operating voltage
Supply current	< 500 mA per channel, short-circuit proof
Low level signal voltage	-3...5 VDC (EN 61131-2, type 2)
High level signal voltage	11...30 VDC (EN 61131-2, type 2)
Input delay	3 ms
Max. input current	6 mA
<b>Outputs</b>	
Number of channels	8 digital outputs acc. to EN 61131-2
Output voltage	20...29 VDC from load voltage
Output current per channel	0.5 A, short-circuit proof
Load type	resistive, inductive, lamp load
Switching frequency	≤ 500 Hz
Simultaneity factor	1
<b>Operating temperature</b>	0 to 55 °C

**Data in process image**

		Bit 7	Bit 6	Bit 5	Bit 4	Bit 3	Bit 2	Bit 1	Bit 0	
PROFIBUS-DP coupling module: "Byte alignment" is disabled (default) and the previous byte has been used halfway. DeviceNet™, CANopen, INTERBUS, Ethernet coupling module: Byte n has been used halfway. Up to 8 bit input data and output data each are mapped.	<b>Input</b>	<b>Byte n</b>	C3P4	C2P4	C1P4	C0P4	is used by the physically preceding bit-oriented extension module connected via the IP Link.			
	<b>Output</b>	<b>Byte n</b>	C3P2	C2P2	C1P2	C0P2				
	<b>Input</b>	<b>Byte n+1</b>	Is used by the physically following bit-oriented extension module connected via the IP Link.				C7P4	C6P4	C5P4	C4P4
	<b>Output</b>	<b>Byte n+1</b>					C7P2	C6P2	C5P2	C4P2
PROFIBUS-DP coupling module: "Byte alignment" is disabled (default) and the previous byte has been completely used or "byte alignment" is activated. DeviceNet™, CANopen, INTERBUS, Ethernet coupling module: The previous byte has been completely used. Up to 8 bit input data and output data each are mapped.	<b>Input</b>	<b>Byte n</b>	C7P4	C6P4	C5P4	C4P4	C3P4	C2P4	C1P4	C0P4
	<b>Output</b>	<b>Byte n</b>	C7P2	C6P2	C5P2	C4P2	C3P2	C2P2	C1P2	C0P2
C... = Connector no. – P... = Pin no.										



**piconet® extension module for IP link**  
**8 digital pnp inputs filter 3 ms**  
**8 digital outputs 0.5 A**

**Device types**

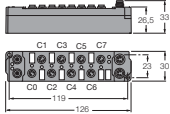
Dimensions	Type	Connection
	<b>6824208 SNNE-0808D-0001</b>	<b>F075, F078, F081</b>

**3**

**Connection**

F075 - Input M8 x 1

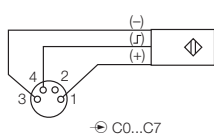

F081 - Voltage supply M8 x 1

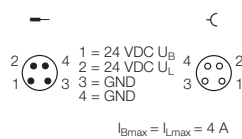

F078 - Output M8 x 1

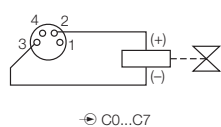

**piconet® extension module for IP link**  
**8 digital pnp inputs filter 3 ms**  
**8 digital outputs 0.5 A**

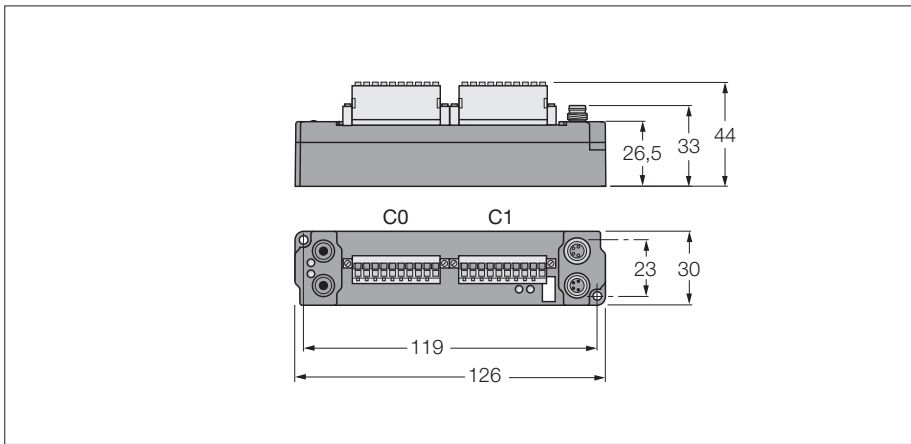

- 8 digital pnp inputs
- 8 digital outputs 0.5 A
- Input filter 3 ms
- Parameterisable functions
- Supported via I/O-ASSISTANT
- Direct connection to the IP link
- IP20 terminals, tension spring connections
- Fibre-glass reinforced PA6 housing
- Encapsulated module electronics
- Metal round connector
- Degree of protection IP20

<b>Operating / load voltage</b>	20...29 VDC
Operating current	≤ 25 mA
<b>Fibre-optic length</b>	≤ 15 m
<b>Inputs</b>	
Number of channels	8 digital inputs acc. to EN 61131-2
Input voltage	20...29 VDC via operating voltage
Supply current	< 500 mA per channel, short-circuit proof
Low level signal voltage	-3...5 VDC (EN 61131-2, type 2)
High level signal voltage	11...30 VDC (EN 61131-2, type 2)
Input delay	3 ms
Max. input current	6 mA
<b>Outputs</b>	
Number of channels	8 digital outputs acc. to EN 61131-2
Output voltage	20...29 VDC from load voltage
Output current per channel	0.5 A, short-circuit proof
Load type	resistive, inductive, lamp load
Switching frequency	≤ 500 Hz
Simultaneity factor	1
<b>Operating temperature</b>	0 to 55 °C

**Data in process image**

			Bit 7	Bit 6	Bit 5	Bit 4	Bit 3	Bit 2	Bit 1	Bit 0
PROFIBUS-DP coupling module: "Byte alignment" is disabled (default) and the previous byte has been used halfway. DeviceNet™, CANopen, INTERBUS, Ethernet coupling module: Byte n has been used halfway. Up to 8 bit input data and output data each are mapped.	<b>Input</b>	<b>Byte n</b>	C0P4	C0P3	C0P2	C0P1	is used by the physically preceding bit-oriented extension module connected via the IP Link.			
	<b>Output</b>	<b>Byte n</b>	C1P4	C1P3	C1P2	C1P1				
PROFIBUS-DP coupling module: "Byte alignment" is disabled (default) and the previous byte has been completely used or "byte alignment" is activated. DeviceNet™, CANopen, INTERBUS, Ethernet coupling module: The previous byte has been completely used. Up to 8 bit input data and output data each are mapped.	<b>Input</b>	<b>Byte n+1</b>	Is used by the physically following bit-oriented extension module connected via the IP Link.				C0P8	C0P7	C0P6	C0P5
	<b>Output</b>	<b>Byte n+1</b>					C1P8	C1P7	C1P6	C1P5
PROFIBUS-DP coupling module: "Byte alignment" is disabled (default) and the previous byte has been completely used or "byte alignment" is activated. DeviceNet™, CANopen, INTERBUS, Ethernet coupling module: The previous byte has been completely used. Up to 8 bit input data and output data each are mapped.	<b>Input</b>	<b>Byte n</b>	C0P8	C0P7	C0P6	C0P5	C0P4	C0P3	C0P2	C0P1
	<b>Output</b>	<b>Byte n</b>	C1P8	C1P7	C1P6	C1P5	C1P4	C1P3	C1P2	C1P1
C... = Connector no. – P... = Pin no.										

**piconet® extension module for IP link**  
**8 digital pnp inputs filter 3 ms**  
**8 digital outputs 0.5 A**

**Device types**

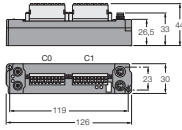
Dimensions	Type	Connection
	<b>6824473 SNNE-0808D-0003</b>	<b>F122, F123, F081</b>

3

**Connection**

F122 - Input IP20 terminal

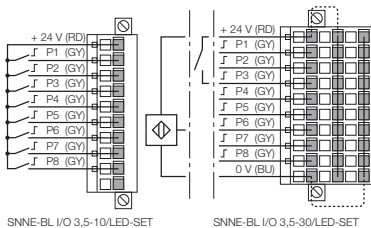

F123 - Output IP20 terminal

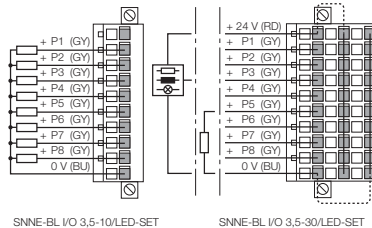

F081 - Voltage supply M8 x 1

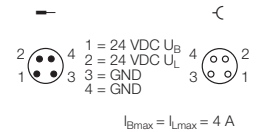

**piconet® extension module for IP link**  
**4 analogue inputs ±10 V**

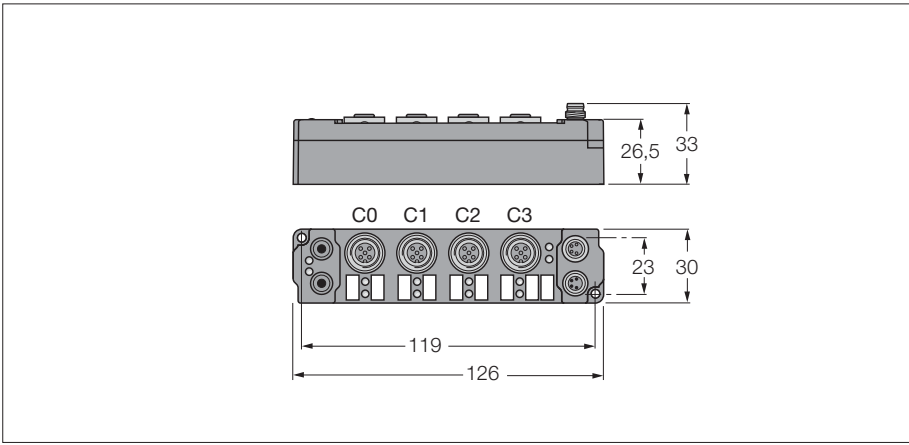

- 4 analogue inputs ±10 V
- Parameterisable functions
- Supported via I/O-ASSISTANT
- Direct connection to the fieldbus
- Fibre-glass reinforced PA6 housing
- Encapsulated module electronics
- Metal connector
- Degree of protection IP67

<b>Operating / load voltage</b>	20...29 VDC
Operating current	≤ 55 mA
<b>Fibre-optic length</b>	≤ 15 m
<b>Inputs</b>	
Number of channels	4 analogue inputs ± 10 V
Input resistance	> 100 Ω
Electrical isolation	channels to operational voltage
<b>Common mode voltage</b>	
	max. 35 V
Measuring current	0.5 mA
Conversion time	250 ms
Relative measuring error	< +- 0.3 % of full scale
Input filter	variable
Sensor supply	from load voltage
<b>Operating temperature</b>	0 to 55 °C

**Data in process image**

Valid for the setting "Motorola format"

SBn: Status byte channel n  
 CBn: Control byte channel n  
 Chn D0: channel n,  
 least significant data byte  
 Chn D1: channel n,  
 most significant data byte

Pre-conditions	Address	Input data		Output data	
	Word	High-Byte	Low-Byte	High-Byte	Low-Byte
<b>Compact mapping:</b> Starting with Ch0 D1 in "Low-Byte" word 0 all other bytes follow immediately. Only the user data are mapped (greyed in the table). <b>Complex mapping:</b> Data are mapped with control and status byte.	0	Ch0 D1	SB0	Ch0 D1	CB0
	1	SB1	Ch0 D0	CB1	Ch0 D0
	2	Ch1 D0	Ch1 D1	Ch1 D0	Ch1 D1
	3	Ch2 D1	SB2	Ch2 D1	CB2
	4	SB3	Ch2 D0	CB3	Ch2 D0
	5	Ch3 D0	Ch3 D1	Ch3 D0	Ch3 D1

**piconet® extension module for IP link**  
**4 analogue inputs ±10 V**

**Device types**

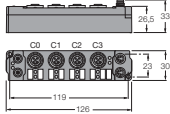
Dimensions	Type	Connection
	<b>6824216 SNNE-40A-0005</b>	F087, F124, F091

**Connection**

F087 - Input M12 x 1

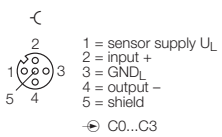

F091 - Voltage supply M8 x 1

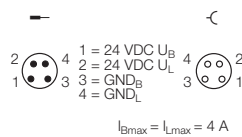

F124 - Connection - Inputs

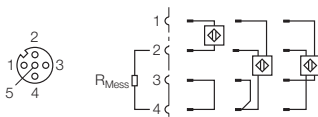

**piconet® extension module for IP link**  
**4 analogue inputs 0(4)... 20 mA**

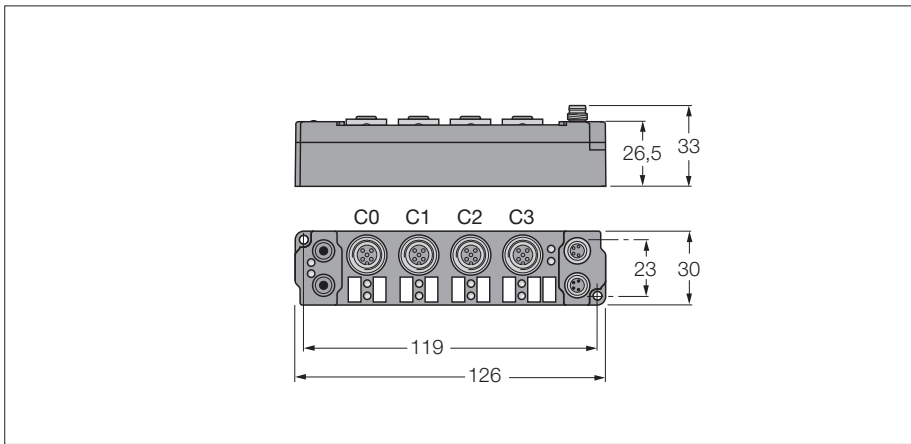

- 4 analogue inputs 0(4)...20 mA
- Parameterisable functions
- Supported via I/O-ASSISTANT
- Direct connection to the fieldbus
- Fibre-glass reinforced PA6 housing
- Encapsulated module electronics
- Metal connector
- Degree of protection IP67

<b>Operating / load voltage</b>	20...29 VDC
Operating current	≤ 55 mA
<b>Fibre-optic length</b>	≤ 15 m
<b>Inputs</b>	
Number of channels	4 analogue inputs 20 mA
Input resistance	80 Ω
Electrical isolation	channels to operational voltage
<b>Common mode voltage</b>	
Measuring current	0.5 mA
Conversion time	250 ms
Relative measuring error	< +- 0.3 % of full scale
Input filter	variable
Sensor supply	from load voltage
<b>Operating temperature</b>	0 to 55 °C

**Data in process image**

Valid for the setting "Motorola format"

SBn: Status byte channel n  
 CBn: Control byte channel n  
 Chn D0: channel n,  
 least significant data byte  
 Chn D1: channel n,  
 most significant data byte

Pre-conditions	Address	Input data		Output data	
	Word	High-Byte	Low-Byte	High-Byte	Low-Byte
<b>Compact mapping:</b> Starting with Ch0 D1 in "Low-Byte" word 0 all other bytes follow immediately. Only the user data are mapped (greyed in the table). <b>Complex mapping:</b> Data are mapped with control and status byte.	0	Ch0 D1	SB0	Ch0 D1	CB0
	1	SB1	Ch0 D0	CB1	Ch0 D0
	2	Ch1 D0	Ch1 D1	Ch1 D0	Ch1 D1
	3	Ch2 D1	SB2	Ch2 D1	CB2
	4	SB3	Ch2 D0	CB3	Ch2 D0
	5	Ch3 D0	Ch3 D1	Ch3 D0	Ch3 D1

**piconet® extension module for IP link**  
**4 analogue inputs 0(4)... 20 mA**

**Device types**

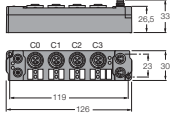
Dimensions	Type	Connection
	<b>6824217 SNNE-40A-0007</b>	F087, F124, F091

**Connection**

F087 - Input M12 x 1

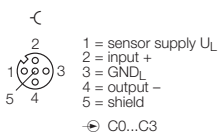

F091 - Voltage supply M8 x 1

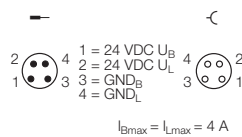

F124 - Connection - Inputs

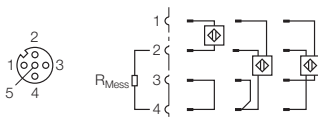

**piconet® extension module for IP link**  
**4 analogue inputs for Pt100**

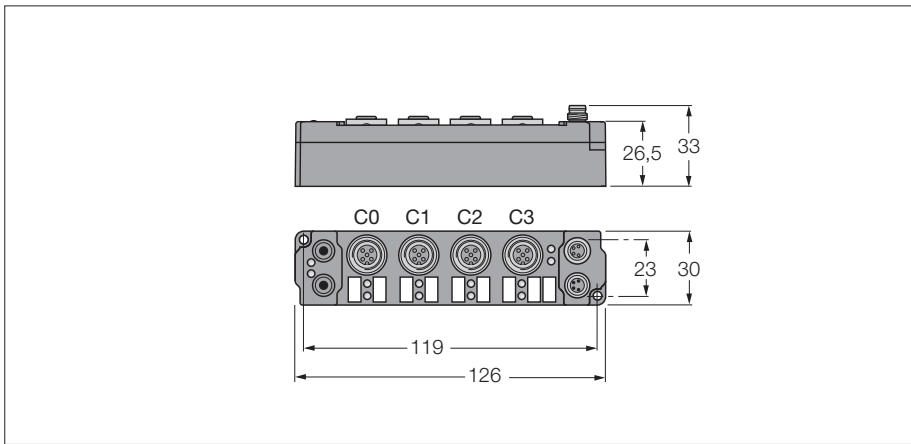

- 4 analogue inputs for Pt100
- Parameterisable functions
- Supported via I/O-ASSISTANT
- Direct connection to the fieldbus
- Fibre-glass reinforced PA6 housing
- Encapsulated module electronics
- Metal connector
- Degree of protection IP67

<b>Operating / load voltage</b>	20...29 VDC
Operating current	≤ 40 mA
<b>Fibre-optic length</b>	≤ 15 m
<b>Inputs</b>	
Number of channels	4 analogue inputs Pt100
Electrical isolation	channels to operational voltage
<b>Sensor type</b>	
Temperature range	Pt100 -200 to 850 °C (Pt sensors), -60 to 250 °C (Ni sensors)
<b>Measuring current</b>	
Conversion time	0.1 °C
Relative measuring error	250 ms
Input filter	< +-1.0 % of full scale
Sensor supply	variable
<b>Operating temperature</b>	from operational voltage
	0 to 55 °C

**Data in process image**

Valid for the setting "Motorola format"

SBn: Status byte channel n  
 CBn: Control byte channel n  
 Chn D0: channel n, least significant data byte  
 Chn D1: channel n, most significant data byte

Pre-conditions	Address	Input data		Output data	
	Word	High-Byte	Low-Byte	High-Byte	Low-Byte
<b>Compact mapping:</b> Starting with Ch0 D1 in "Low-Byte" word 0 all other bytes follow immediately. Only the user data are mapped (greyed in the table). <b>Complex mapping:</b> Data are mapped with control and status byte.	0	Ch0 D1	SB0	Ch0 D1	CB0
	1	SB1	Ch0 D0	CB1	Ch0 D0
	2	Ch1 D0	Ch1 D1	Ch1 D0	Ch1 D1
	3	Ch2 D1	SB2	Ch2 D1	CB2
	4	SB3	Ch2 D0	CB3	Ch2 D0
	5	Ch3 D0	Ch3 D1	Ch3 D0	Ch3 D1



**piconet® extension module for IP link**  
**4 analogue inputs for Pt100**

**Device types**

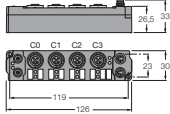
Dimensions	Type	Connection
	<b>6824176 SNNE-40A-0009</b>	F088, F125, F091

**Connection**

F088 - Input M12 x 1

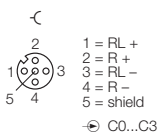

F091 - Voltage supply M8 x 1

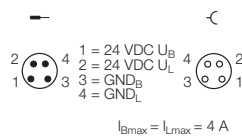

F125 - Connection - Inputs

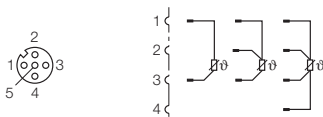

## **piconet® extension module for IP link** **4 analogue inputs for thermoelements**

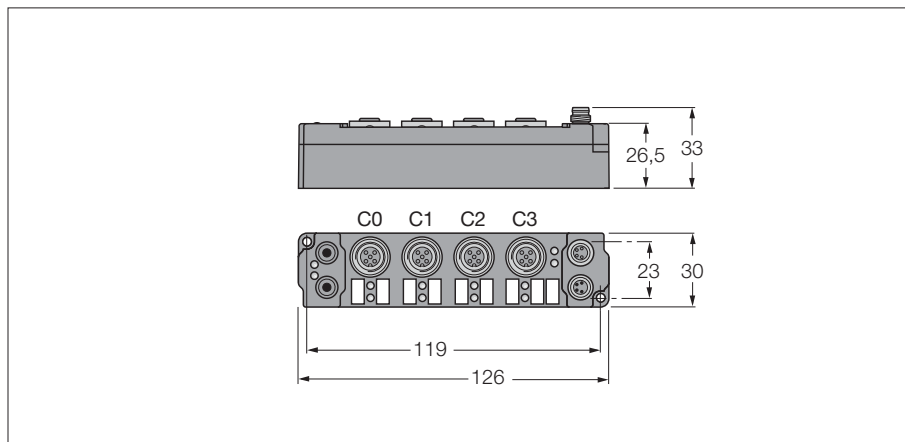

- 4 analogue inputs for thermoelements
- Parameterisable functions
- Supported via I/O-ASSISTANT
- Direct connection to the fieldbus
- Fibre-glass reinforced PA6 housing
- Encapsulated module electronics
- Metal connector
- Degree of protection IP67

<b>Operating / load voltage</b>	20...29 VDC
Operating current	≤ 40 mA
<b>Fibre-optic length</b>	≤ 15 m
<b>Inputs</b>	
Number of channels	4 analogue thermoelement inputs
Electrical isolation	channels to operational voltage
<b>Sensor type</b>	K
Temperature range	Sensor sensor (default type K)
<b>Conversion time</b>	250 ms
Relative measuring error	< +/-0.5 % of full scale
Input filter	variable
Sensor supply	from operational voltage
<b>Operating temperature</b>	0 to 55 °C

### **Data in process image**

Valid for the setting "Motorola format"

SBn: Status byte channel n  
 CBn: Control byte channel n  
 Chn D0: channel n,  
 least significant data byte  
 Chn D1: channel n,  
 most significant data byte

Pre-conditions	Address	Input data		Output data	
	Word	High-Byte	Low-Byte	High-Byte	Low-Byte
<b>Compact mapping:</b> Starting with Ch0 D1 in "Low-Byte" word 0 all other bytes follow immediately. Only the user data are mapped (greyed in the table).  <b>Complex mapping:</b> Data are mapped with control and status byte.	0	Ch0 D1	SB0	Ch0 D1	CB0
	1	SB1	Ch0 D0	CB1	Ch0 D0
	2	Ch1 D0	Ch1 D1	Ch1 D0	Ch1 D1
	3	Ch2 D1	SB2	Ch2 D1	CB2
	4	SB3	Ch2 D0	CB3	Ch2 D0
	5	Ch3 D0	Ch3 D1	Ch3 D0	Ch3 D1

**piconet® extension module for IP link  
4 analogue inputs for thermoelements**

**Device types**

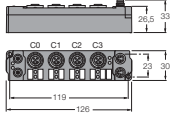
Dimensions	Type	Connection
	<b>6824215 SNNE-40A-0004</b>	F086, F126, F091

**Connection**

F086 - Input M12 x 1

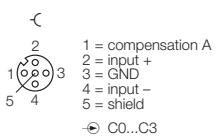

F091 - Voltage supply M8 x 1

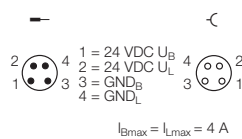

F126 - Connection - Inputs



**piconet® extension module for IP link**  
**4 analogue outputs ±10 V**

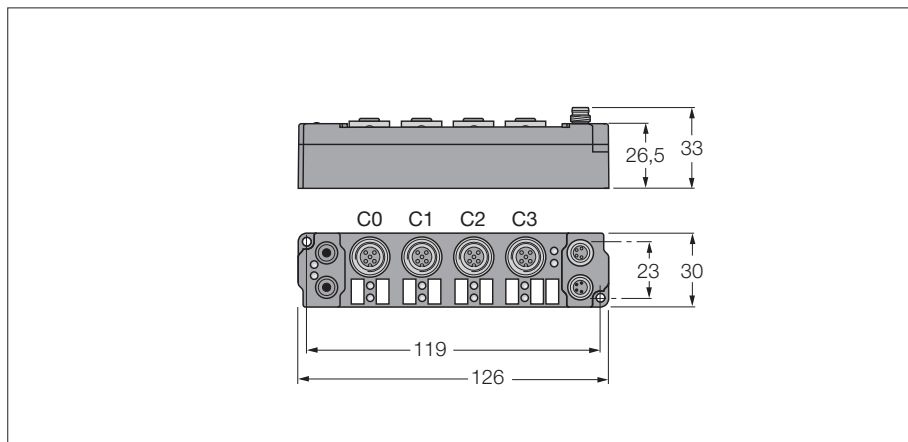

- 4 analogue outputs ±10 V
- Parameterisable functions
- Supported via I/O-ASSISTANT
- Direct connection to the fieldbus
- Fibre-glass reinforced PA6 housing
- Encapsulated module electronics
- Metal connector
- Degree of protection IP67

<b>Operating / load voltage</b>	20...29 VDC
Operating current	≤ 40 mA
<b>Fibre-optic length</b>	≤ 15 m
<b>Outputs</b>	
Number of channels	4 analogue outputs ± 10 V
Load resistance	> 5000 Ω
Electrical isolation	channels to operational voltage
<b>Conversion time</b>	
Relative measuring error	< 1 ms
Actuator power supply	< ± 0.3 % of full scale
<b>Operating temperature</b>	from load voltage
	0 to 55 °C

**Data in process image**

Valid for the setting "Motorola format"

SBn: Status byte channel n  
 CBn: Control byte channel n  
 Chn D0: channel n,  
 least significant data byte  
 Chn D1: channel n,  
 most significant data byte

Pre-conditions	Address	Input data		Output data	
	Word	High-Byte	Low-Byte	High-Byte	Low-Byte
<b>Compact mapping:</b> Starting with Ch0 D1 in "Low-Byte" word 0 all other bytes follow immediately. Only the user data are mapped (greyed in the table).  <b>Complex mapping:</b> Data are mapped with control and status byte.	0	Ch0 D1	SB0	Ch0 D1	CB0
	1	SB1	Ch0 D0	CB1	Ch0 D0
	2	Ch1 D0	Ch1 D1	Ch1 D0	Ch1 D1
	3	Ch2 D1	SB2	Ch2 D1	CB2
	4	SB3	Ch2 D0	CB3	Ch2 D0
5	Ch3 D0	Ch3 D1	Ch3 D0	Ch3 D1	

**piconet® extension module for IP link**  
**4 analogue outputs ±10 V**

**Device types**

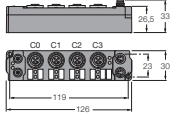
Dimensions	Type	Connection
	<b>6824200 SNNE-04A-0007</b>	F127, F128, F091

**Connection**

F127 - Output M12 x 1

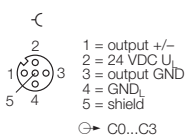

F091 - Voltage supply M8 x 1

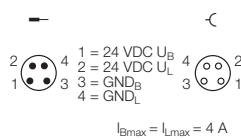

F128 - Connection - Outputs

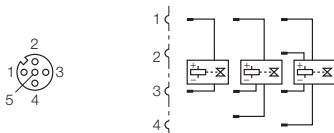

**piconet® extension module for IP link**  
**4 analogue outputs 0...20 mA**

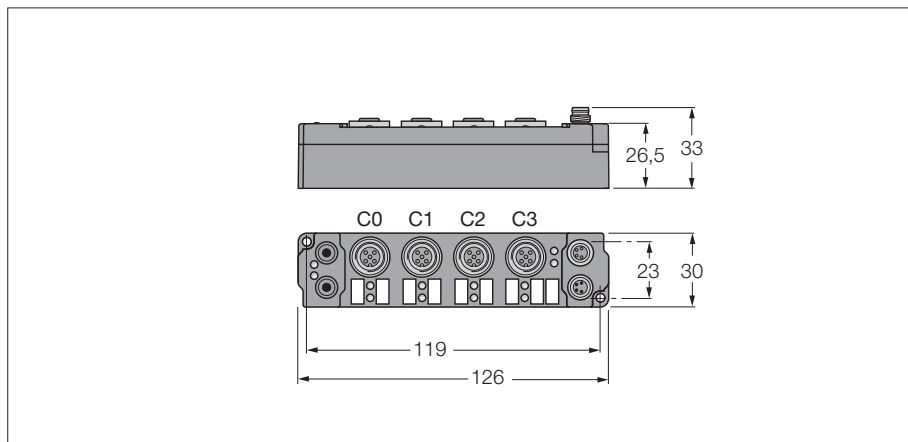

- 4 analogue outputs 0(4)...20 mA
- Parameterisable functions
- Supported via I/O-ASSISTANT
- Direct connection to the fieldbus
- Fibre-glass reinforced PA6 housing
- Encapsulated module electronics
- Metal connector
- Degree of protection IP67

<b>Operating / load voltage</b>	20...29 VDC
Operating current	≤ 40 mA
<b>Fibre-optic length</b>	≤ 15 m
<b>Outputs</b>	
Number of channels	4 analogue outputs 20 mA
Load resistance	< 500 Ω
Electrical isolation	channels to operational voltage
<b>Conversion time</b>	
Relative measuring error	< ± 0.3 % of full scale
Actuator power supply	from load voltage
<b>Operating temperature</b>	0 to 55 °C

**Data in process image**

Valid for the setting "Motorola format"

SBn: Status byte channel n  
 CBn: Control byte channel n  
 Chn D0: channel n,  
 least significant data byte  
 Chn D1: channel n,  
 most significant data byte

Pre-conditions	Address	Input data		Output data	
	Word	High-Byte	Low-Byte	High-Byte	Low-Byte
<b>Compact mapping:</b> Starting with Ch0 D1 in "Low-Byte" word 0 all other bytes follow immediately. Only the user data are mapped (greyed in the table).  <b>Complex mapping:</b> Data are mapped with control and status byte.	0	Ch0 D1	SB0	Ch0 D1	CB0
	1	SB1	Ch0 D0	CB1	Ch0 D0
	2	Ch1 D0	Ch1 D1	Ch1 D0	Ch1 D1
	3	Ch2 D1	SB2	Ch2 D1	CB2
	4	SB3	Ch2 D0	CB3	Ch2 D0
5	Ch3 D0	Ch3 D1	Ch3 D0	Ch3 D1	

**piconet® extension module for IP link**  
**4 analogue outputs 0...20 mA**

**Device types**

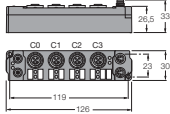
Dimensions	Type	Connection
	<b>6824201 SNNE-04A-0009</b>	F127, F128, F091

3

**Connection**

F127 - Output M12 x 1

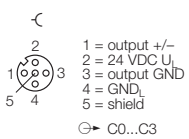

F091 - Voltage supply M8 x 1

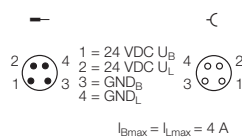

F128 - Connection - Outputs

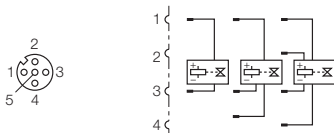

**piconet® extension module for IP link**  
**2-channel pulse width modulation (PWM)**

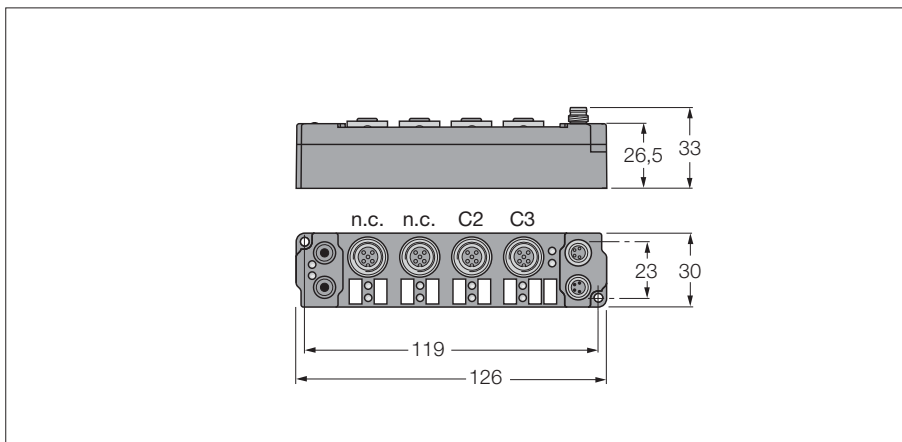

- Pulse width modulation
- 2-channel
- 2.5 A per channel
- Parameterisable functions
- Supported via I/O-ASSISTANT
- Direct connection to the fieldbus
- Fibre-glass reinforced PA6 housing
- Encapsulated module electronics
- Metal connector
- Degree of protection IP67

<b>Operating / load voltage</b>	20...29 VDC
Operating current	≤ 25 mA
<b>Fibre-optic length</b>	≤ 15 m
<b>V/R output</b>	0.5 A short-circuit proof
Output current per channel	2.5
Load type	resistive, inductive
<b>Base frequency</b>	1 Hz...10 kHz (default 250 Hz)
Duty factor	0...100 % (t ON > 750 ns, t OFF > 500 ns)
Resolution	10 Bit
Freewheeling diode	on the outputs
<b>Operating temperature</b>	0 to 55 °C

**Data in process image**

Pre-conditions	Address	Input data		Output data	
	Word	High-Byte	Low-Byte	High-Byte	Low-Byte
<b>Complex mapping:</b> Data are mapped with control and status byte	<b>0</b>	Ch0 Reg1	SB0	Ch0 D1	CB0
	<b>1</b>	SB1	Ch0 Reg0	CB1	Ch0 D0
	<b>2</b>	Ch1 Reg0	Ch1 Reg1	Ch1 D0	Ch1 D1



**piconet® extension module for IP link  
2-channel pulse width modulation (PWM)**

**Device types**

Dimensions	Type	Connection
	<b>6824177 SNNE-0002D-0002</b>	F092, F081

**Connection**

F092 - Output M12 x 1

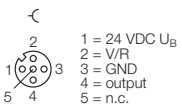

F081 - Voltage supply M8 x 1

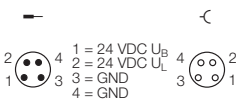

$I_{Bmax} = I_{Lmax} = 4 A$

**piconet® extension module for IP link**  
**2-channel up/down counter**

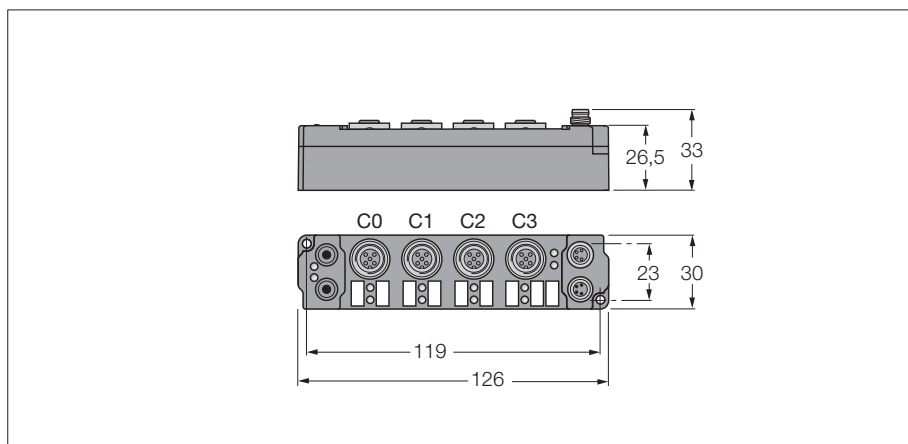

- Up/down counter
- 2-channel
- Switching frequency 100 kHz
- Parameterisable functions
- Supported via I/O-ASSISTANT
- Direct connection to the fieldbus
- Fibre-glass reinforced PA6 housing
- Encapsulated module electronics
- Metal connector
- Degree of protection IP67

<b>Operating / load voltage</b>	20...29 VDC
Operating current	≤ 30 mA
<b>Fibre-optic length</b>	≤ 15 m
<b>Number of channels</b>	2 count-, 2 gate inputs, 2 V/R changeover contacts
Low level signal voltage	-3 to 5 VDC
Switching frequency	≤ 100000 Hz
<b>Number of channels</b>	2 x 24 VDC/0.5 A, short-circuit proof
<b>High level signal voltage</b>	11 to 30 VDC
Current consumption	≤ 10 mA
Sensor supply	short-circuit proof, max. 0.5 A from operating voltage
<b>Operating temperature</b>	0 to 55 °C

**Data in process image**

Pre-conditions	Adresse	Input data		Output data	
	Word	High-Byte	Low-Byte	High-Byte	Low-Byte
<b>Complex mapping:</b> Data are mapped with control and status byte	<b>0</b>	Ch0 D3	SB0	Ch0 D3	CB0
	<b>1</b>	Ch0 D1	Ch0 D2	Ch0 D1	Ch0 D2
	<b>2</b>	SB1	Ch0 D0	CB1	Ch0 D0
	<b>3</b>	Ch1 D2	Ch1 D3	Ch1 D2	Ch1 D3
	<b>4</b>	Ch1 D0	Ch1 D1	Ch1 D0	Ch1 D1

**piconet® extension module for IP link  
2-channel up/down counter**

**Device types**

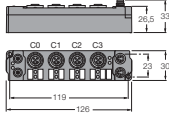
Dimensions	Type	Connection
	<b>6824187 SNNE-0202D-0003</b>	F093, F129, F081

**3**

**Connection**

F093 - Input M12 x 1

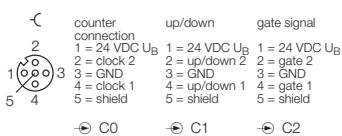

F081 - Voltage supply M8 x 1

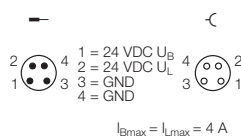

F129 - Output M12 x 1

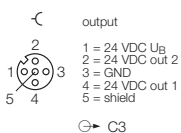

## **piconet® extension module for IP link single-channel incremental encoder interface**

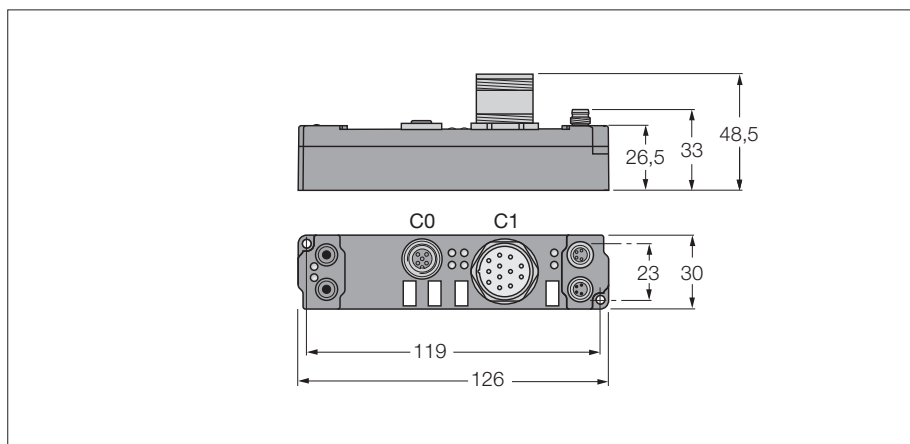

- Incremental encoder interface
- 1-channel
- Parameterisable functions
- Supported via I/O-ASSISTANT
- Direct connection to the fieldbus
- Fibre-glass reinforced PA6 housing
- Encapsulated module electronics
- Metal connector
- Degree of protection IP67

<b>Operating / load voltage</b>	20...29 VDC
Operating current	≤ 55 mA
<b>Fibre-optic length</b>	≤ 15 m
<b>Maximum limiting frequency, analogue</b>	1 MHz Hz
Rectangular decoder	1-port, 2-port, 4-port evaluation
Counter	16 bit binary
Actuator power supply	5 VDC
Zero pulse latch	16 bit
Commands	read, set, activate
<b>Operating temperature</b>	0 to 55 °C

### Data in process image

Pre-conditions	Address	Input data		Output data	
	Word	High-Byte	Low-Byte	High-Byte	Low-Byte
<b>Complex mapping:</b> Data are mapped with control and status byte	<b>0</b>	D1	SB	Reg1	CB
	<b>1</b>	D2	D0	reserved	Reg0
	<b>2</b>	D3	D4	reserved	reserved

**piconet® extension module for IP link  
single-channel incremental encoder interface**

**Device types**

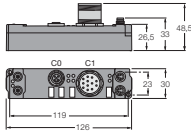
Dimensions	Type	Connection
	<b>6824210 SNNE-10S-0001</b>	F095, F110, F081

**Connection**

F095 - Gate / latch Input M12 x 1

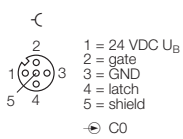

F081 - Voltage supply M8 x 1

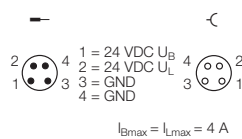

F110 - Encoder - M23 x 1

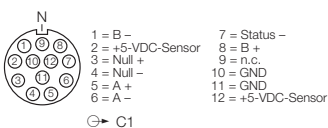

**piconet® extension module for IP link**  
**Single channel serial interface RS232**

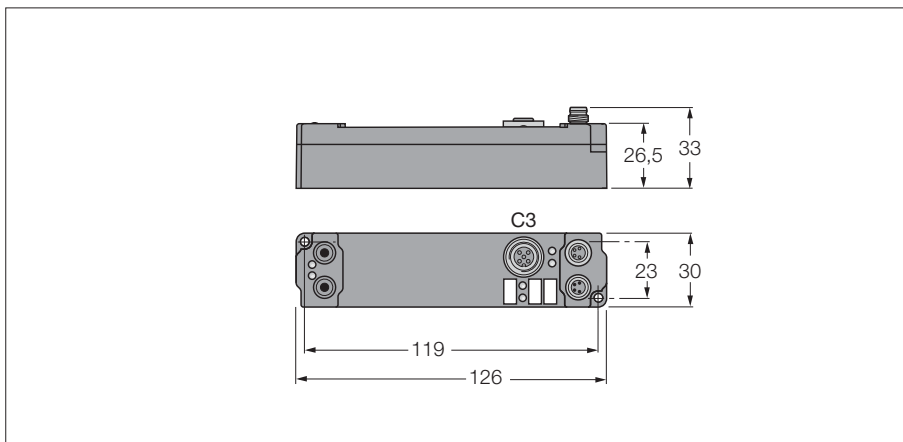

- Serial interface RS232
- 1-channel
- Parameterisable functions
- Supported via I/O-ASSISTANT
- Direct connection to the fieldbus
- Fibre-glass reinforced PA6 housing
- Encapsulated module electronics
- Metal connector
- Degree of protection IP67

<b>Operating / load voltage</b>	20...29 VDC
Operating current	≤ 40 mA
<b>Fibre-optic length</b>	≤ 15 m
<b>Bit distortion</b>	≤ 3 %
Transmission rate	1.2 to 19.2 kBit/s (default 9.6 kbps)
RS232 Cable length	≤ 15 m
Low level signal voltage	-18 to -3 VDC
High level signal voltage	3 to 18 VDC
Data buffer	128 byte receive buffer, 16 byte send buffer
<b>Operating temperature</b>	0 to 55 °C

**Data in process image**

Pre-conditions	Address	Input data		Output data	
	Word	High-Byte	Low-Byte	High-Byte	Low-Byte
<b>Complex mapping:</b> Data are mapped with control and status byte	<b>0</b>	D0	SB	D0	CB
	<b>1</b>	D2	D1	D2	D1
	<b>2</b>	D4	D3	D4	D3

**piconet® extension module for IP link**  
**Single channel serial interface RS232**

**Device types**

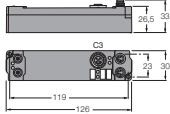
Dimensions	Type	Connection
	<b>6824211 SNNE-10S-0002</b>	<b>F111, F081</b>

**Connection**

F111 - Input M12 x 1

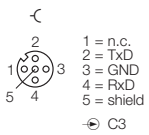

F081 - Voltage supply M8 x 1

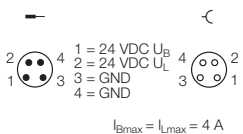

**piconet® extension module for IP link**  
**Single channel serial interface 0...20 mA (TTY)**

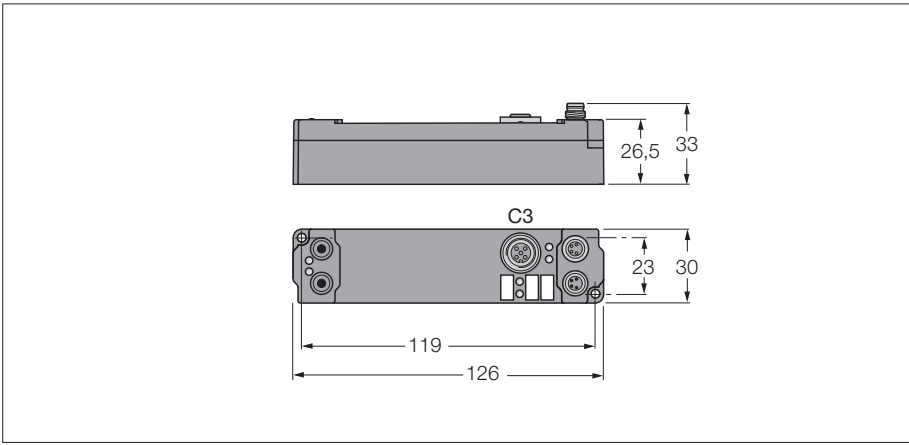

- Serial interface 0...20 mA (TTY)
- 1-channel
- Parameterisable functions
- Supported via I/O-ASSISTANT
- Direct connection to the fieldbus
- Fibre-glass reinforced PA6 housing
- Encapsulated module electronics
- Metal connector
- Degree of protection IP67

<b>Operating / load voltage</b>	20...29 VDC
Operating current	≤ 40 mA
<b>Fibre-optic length</b>	≤ 15 m
<b>Low level signal current</b>	0 to 3 mA
High level signal current	14 to 20 mA
<b>Load resistance</b>	≤ 500 Ω
<b>Bit transfer</b>	2 x 20 mA
Transmission rate	1.2 to 19.2 kBit/s (default 9.6 kbps)
Transfer circuit	twisted pair ≤ 1000 m
Data buffer	128 byte receive buffer, 16 byte send buffer
Electrical isolation	operational voltage to TTY
<b>Operating temperature</b>	0 to 55 °C

**Data in process image**

Pre-conditions	Address	Input data		Output data	
	Word	High-Byte	Low-Byte	High-Byte	Low-Byte
<b>Complex mapping:</b> Data are mapped with control and status byte	<b>0</b>	D0	SB	D0	CB
	<b>1</b>	D2	D1	D2	D1
	<b>2</b>	D4	D3	D4	D3



**piconet® extension module for IP link**  
**Single channel serial interface 0...20 mA (TTY)**

**Device types**

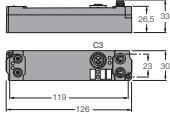
Dimensions	Type	Connection
	<b>6824212 SNNE-10S-0003</b>	F094, F130, F081

**Connection**

F094 - Input M12 x 1

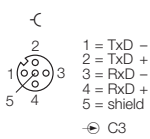

F081 - Voltage supply M8 x 1

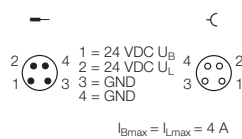

F130 - Connection - passive TTY devices

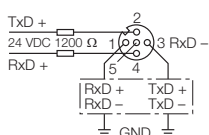

**piconet® extension module for IP link**  
**Single channel serial interface RS232/RS485**

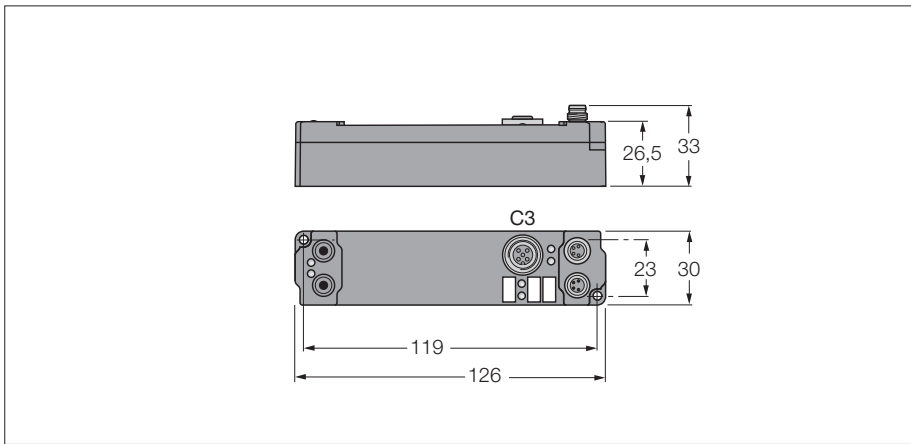

- Serial interface RS422/485
- 1-channel
- Parameterisable functions
- Supported via I/O-ASSISTANT
- Direct connection to the fieldbus
- Fibre-glass reinforced PA6 housing
- Encapsulated module electronics
- Metal connector
- Degree of protection IP67

<b>Operating / load voltage</b>	20...29 VDC
Operating current	≤ 40 mA
<b>Fibre-optic length</b>	≤ 15 m
<b>Line impedance</b>	120 Ω
<b>Common mode voltage</b>	max. -7...+12 V (against ground)
Bit transfer	differential
Transmission rate	1.2 to 19.2 kBit/s (default 9.6 kbps)
Transfer circuit	twisted pair ≤ 1000 m
Data buffer	128 byte receive buffer, 16 byte send buffer
Electrical isolation	operating voltage to RS485
<b>Operating temperature</b>	0 to 55 °C

**Data in process image**

Pre-conditions	Address	Input data		Output data	
	Word	High-Byte	Low-Byte	High-Byte	Low-Byte
<b>Complex mapping:</b> Data are mapped with control and status byte	<b>0</b>	D0	SB	D0	CB
	<b>1</b>	D2	D1	D2	D1
	<b>2</b>	D4	D3	D4	D3

**piconet® extension module for IP link**  
**Single channel serial interface RS232/RS485**

**Device types**

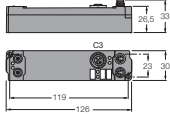
Dimensions	Type	Connection
	<b>6824213 SNNE-10S-0004</b>	F094, F130, F081

**3**

**Connection**

F094 - Input M12 x 1

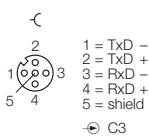

F081 - Voltage supply M8 x 1

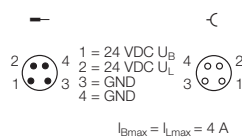

F130 - Connection - RS485 devices

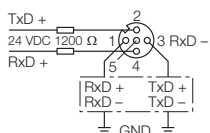

**piconet® extension module for IP link**  
**Single channel SSI sensor interface**

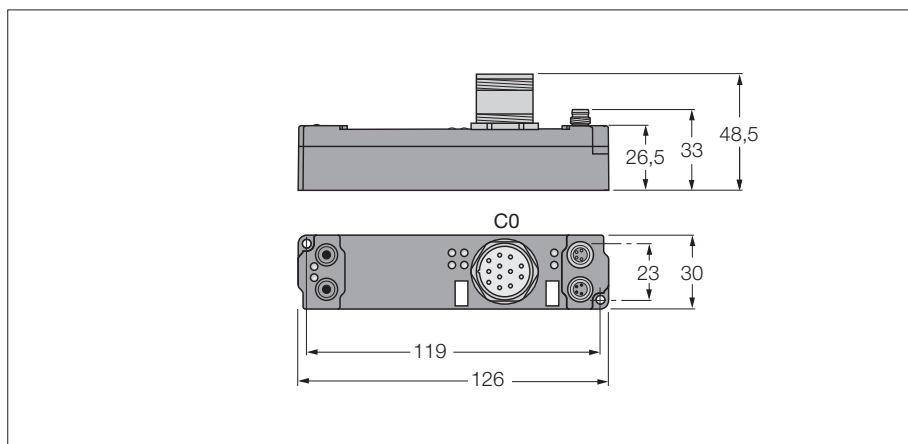

- SSI encoder interface
- 1-channel
- Parameterisable functions
- Supported via I/O-ASSISTANT
- Direct connection to the fieldbus
- Fibre-glass reinforced PA6 housing
- Encapsulated module electronics
- Metal connector
- Degree of protection IP67

<b>Operating / load voltage</b>	20...29 VDC
Operating current	≤ 55 mA
<b>Fibre-optic length</b>	≤ 15 m
<b>Bit transfer</b>	differential (RS485)
Transmission rate	variable up to 1 MHz (default 250 Hz)
Serial input	24 bit
Data direction	read
Sensor supply	24 VDC from load voltage
Electrical isolation	operating voltage to RS232
<b>Operating temperature</b>	0 to 55 °C

**Data in process image**

Pre-conditions	Address	Input data		Output data	
		Word	High-Byte	Low-Byte	High-Byte
<b>Compact mapping:</b> Starting with D3 in "Low-Byte" word 0 all other bytes follow immediately (highlighted in grey). <b>Complex mapping:</b> Data are mapped with control and status byte	<b>0</b>	D3	SB	Reg1	CB
	<b>1</b>	D1	D2	reserved	Reg0
	<b>2</b>	reserved	D0	reserved	reserved

**piconet® extension module for IP link**  
**Single channel SSI sensor interface**

**Device types**

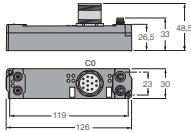
Dimensions	Type	Connection
	<b>6824214 SNNE-10S-0005</b>	F096, F081

**Connection**

F096 - Encoder - M23 x 1

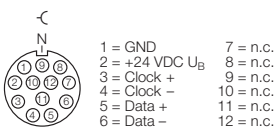

F081 - Voltage supply M8 x 1

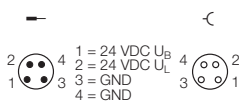

$I_{Bmax} = I_{Lmax} = 4 A$

## **piconet® extension module for IP link** **8 valve slices with max. 16 valve coils**

CPV valve blocks are exclusively sold by FESTO AG & Co.

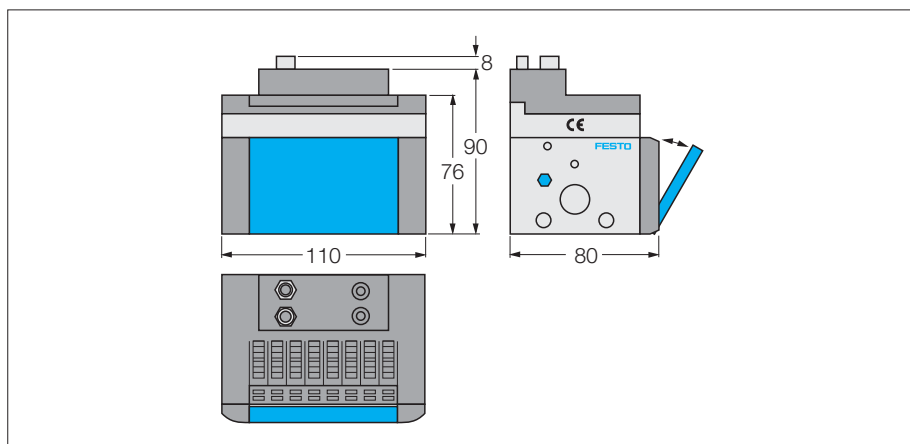

- 8 valve slices
- max. 16 valve coils
- CPV10 10 mm valve slices
- CPV14 14 mm valve slices
- Parameterisable functions
- Supported via I/O-ASSISTANT
- Direct connection to the IP link
- Degree of protection IP65

<b>Operating / load voltage</b>	20...29 VDC
Operating current	≤ 50 mA
<b>Fibre-optic length</b>	≤ 15 m
<b>Electrical isolation</b>	Operation voltage to fieldbus
<b>Operating temperature</b>	0 to 55 °C

### Device types

Dimensions	Type	Connection
	<b>CPV10-VI-IP8-8</b>	F091
	<b>CPV14-VI-IP8-8</b>	F091

### Connection

F091 - Voltage supply M8 x 1

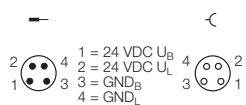

$$I_{Bmax} = I_{Lmax} = 4 \text{ A}$$

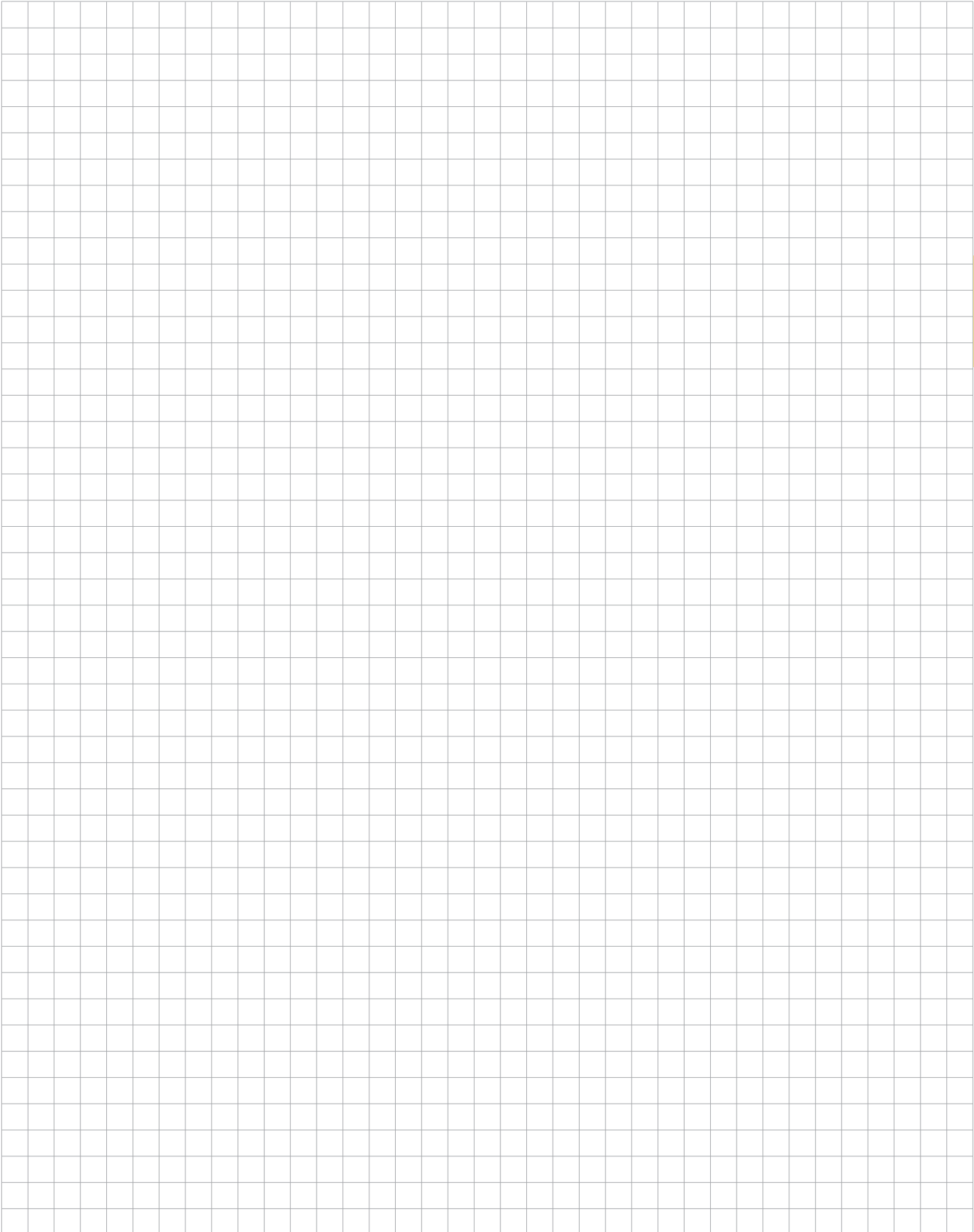

# **piconet® – Stand-alone modules for PROFIBUS**

## **piconet® – Stand-alone modules for PROFIBUS-DP**

**Page**

### **Digital modules**

8 digital inputs, filter 0.2 ms or 3 ms	202
8 digital outputs, 0,5 A	206
8 digital outputs, 2 A ( $I_{\Sigma} = 4 A$ )	208
8 digital outputs, 2 A ( $I_{\Sigma} = 12 A$ )	210
4 digital inputs, filter 0.2 ms or 3 ms and 4 digital outputs, 0,5 A	212
4 digital inputs, filter 0.2 ms or 3 ms and 4 digital outputs, 2 A ( $I_{\Sigma} = 4 A$ )	216
8 digital inputs, filter 3 ms and 8 digital outputs, 0,5 A	220

### **Analogue modules**

4 analogue differential inputs, $\pm 10 V$ , 16 bit	222
4 analogue differential inputs, 0...20 mA, 16 bit	224
4 analogue inputs for Pt100 (RTD)	226
4 analogue inputs for thermoelements	228
4 analogue outputs $\pm 10 V$	230
4 analogue outputs, 0...20 mA	232

### **Technology modules**

2-channel pulse width modulation, 24 VDC, 2,5 A	234
2-channel up/down counter, 100 kHz	236
1-channel incremental encoder interface	238
1-channel serial interface, RS232	240
1-channel serial interface, 0...20 mA (TTY)	242
1-channel serial interface, RS232/RS485	244
1-channel SSI encoder interface	246

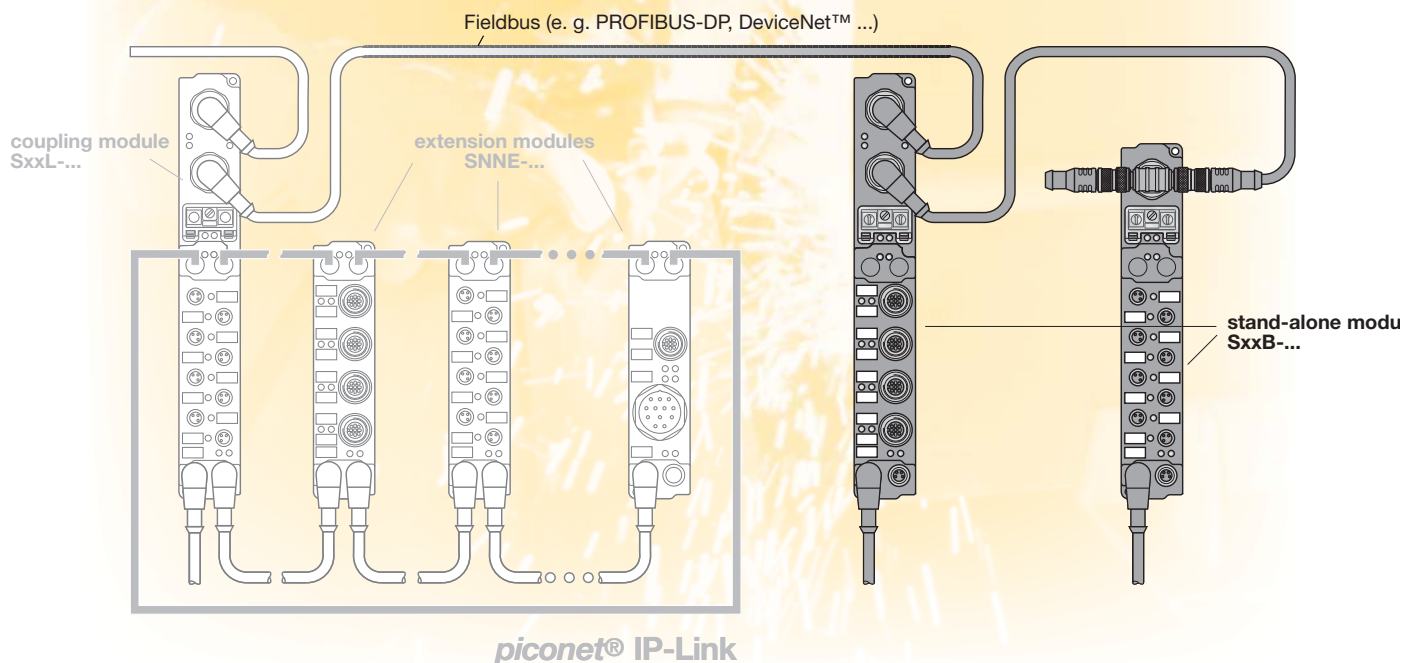



## ***piconet*<sup>®</sup> – Stand-alone modules for PROFIBUS-DP**

*piconet*<sup>®</sup> stand-alone modules connect each *piconet*<sup>®</sup> I/O module directly to the fieldbus. There are versions with one fieldbus connection (separate tee needed) and with two bus connections (tee piece integrated).

The programme comprises modules for the whole spectrum of I/O signals – from standardised digital industrial signals to analogue inputs and outputs. The family is complemented by a choice of technology modules, such as a pulse width modulator, an up/down counter, an incremental encoder as well as various serial interfaces.

The robust IP67 housing is extremely compact, fully encapsulated and equipped throughout with metal connectors. As a result, the *piconet*<sup>®</sup> modules are perfectly suited for application in harsh industrial environments as well as serial and special machine engineering.

Operating and load voltage are – as with all *piconet*<sup>®</sup> module types – fed separately. Alongside the “Power” LED, each channel is assigned a “Status” LED for switching status indications.

### ***piconet*<sup>®</sup> – Stand-alone modules – general technical data**

#### **Adjustment**

Fieldbus address	1...99 (decimal), adjustable via coded rotary switches
Transmission rate	automatic

#### **LED indications (module-specific)**

Fieldbus	fieldbus specific (s. manual)
Operating voltage $U_B$	green: operational
Load voltage $U_L$	green: operational

#### **Connections**

Fieldbus	brass, nickel-plated depending on the type of fieldbus system used
Power supply	(1) M8 male connectors, 4-pole, (1) M8 female connectors, 4-pole
Inputs/outputs	selectable: (8) M8 female connectors, 3-pole, or (4) M12 female connectors, 5-pole
Service interface	(1) terminal strip, 5-pole (for I/O-ASSISTANT)

#### **Housing**

Material	compact, fully encapsulated plastic housing PA6 (Polyamid)
Dimensions – device with 1 fieldbus connection	175 x 30 x 26.5 mm (H x W x D)
Dimensions – device with 2 fieldbus connections	210 x 30 x 26.5 mm (H x W x D)
Mounting	via 2 through-holes, Ø 3 mm
Mounting position	any
Operating temperature (range)	0 °C to +55 °C (+32 °F to +131 °F)
Operating temperature (storage)	-25 °C to +85 °C (-13 °F to +185 °F)
Degree of protection (IEC 60529/EN 60529)	IP65, IP66, IP67
Vibration and shock testing	according to IEC 68, part 2-6 / IEC 68, part 2-27
Electromagnetic capability (EMC)	according to EN 50081-2/EN 50082-2
Weight	approx. 250–280 g (depending on type)
Approvals	CE, 



**Please note:** further technical information is contained in the *piconet*<sup>®</sup> user manuals.

Additionally available to PROFIBUS-DP are stand-alone modules for DeviceNet™ and CANopen. For more detailed information concerning the availability of correspondent signal forms, please contact the Hans Turck GmbH & Co KG directly.

**piconet® stand-alone module for PROFIBUS-DP**  
**8 digital pnp inputs filter 3 ms**

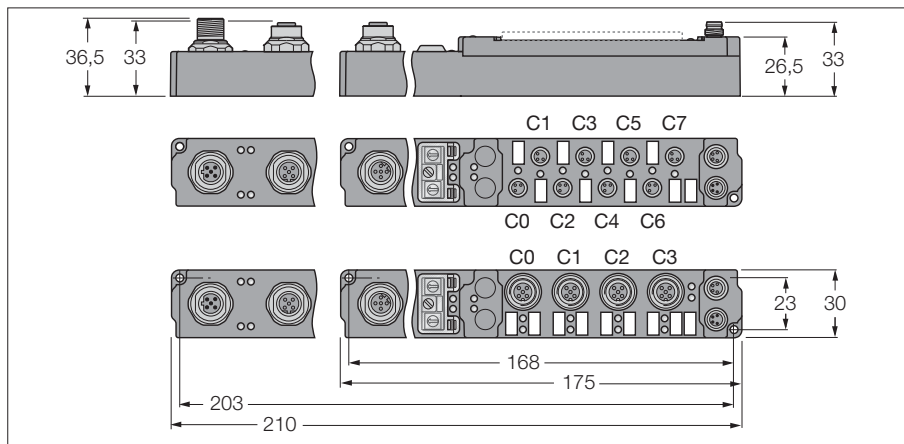

- 8 digital pnp inputs
- Input filter 3 ms
- Configuration interface
- Parameterisable functions
- Supported via I/O-ASSISTANT
- Direct connection to the fieldbus
- Fibre-glass reinforced PA6 housing
- Encapsulated module electronics
- Metal connector
- Degree of protection IP67

<b>Operating / load voltage</b>	20...29 VDC
Operating current	≤ 85 mA
<b>Fieldbus transmission rate</b>	9.6 kbps up to 12 Mbps
Fieldbus addressing	0 to 99
Service interface	parameterisation via I/O-ASSISTANT
Electrical isolation	fieldbus to operational voltage
<b>Inputs</b>	
Number of channels	8 digital inputs acc. to EN 61131-2
Input voltage	20...29 VDC via operating voltage
Supply current	< 500 mA per channel, short-circuit proof
Low level signal voltage	-3...5 VDC (EN 61131-2, type 2)
High level signal voltage	11...30 VDC (EN 61131-2, type 2)
Input delay	3 ms
Max. input current	6 mA
<b>Operating temperature</b>	0 to 55 °C

**Data in process image**

		Bit 7	Bit 6	Bit 5	Bit 4	Bit 3	Bit 2	Bit 1	Bit 0
Input	Byte 0 (M8)	C7P4	C6P4	C5P4	C4P4	C3P4	C2P4	C1P4	C0P4
	Byte 0 (M12)	C3P2	C3P4	C2P2	C2P4	C1P2	C1P4	C0P2	C0P4

C... = Connector No., P... = Pin No.

**piconet® stand-alone module for PROFIBUS-DP**  
**8 digital pnp inputs filter 3 ms**

**Device types**

Dimensions	Type	Connection
	<b>6824071 SDPB-0800D-0004</b>	F083, F117, F081
	<b>6824058 SDPB-0800D-0007</b>	F083, F077, F081
	<b>6824410 SDPB-0800D-1004</b>	F084, F117, F081
	<b>6824409 SDPB-0800D-1007</b>	F084, F077, F081

**3**

**Connection**

F083 - Fieldbus M12 x 1

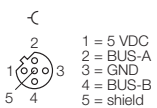

F117 - Input M12 x 1

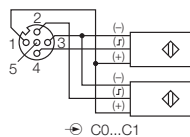

F081 - Voltage supply M8 x 1

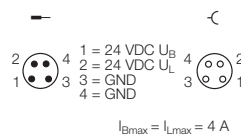

F084 - Fieldbus M12 x 1

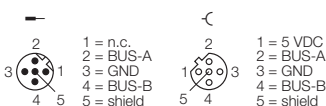

F077 - Input M8 x 1

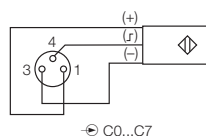

**piconet® stand-alone module for PROFIBUS-DP**  
**8 digital pnp inputs filter 0.2 ms**

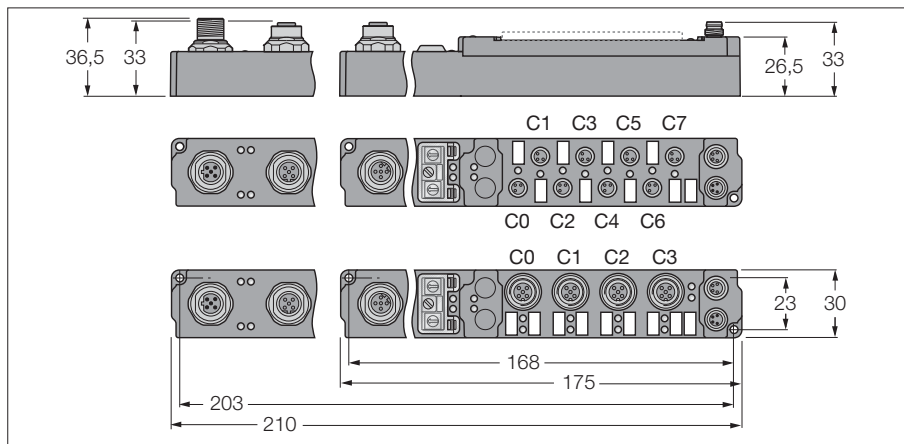

- 8 digital pnp inputs
- Input filter 0.2 ms
- Configuration interface
- Parameterisable functions
- Supported via I/O-ASSISTANT
- Direct connection to the fieldbus
- Fibre-glass reinforced PA6 housing
- Encapsulated module electronics
- Metal connector
- Degree of protection IP67

<b>Operating / load voltage</b>	20...29 VDC
Operating current	≤ 85 mA
<b>Fieldbus transmission rate</b>	9.6 kbps up to 12 Mbps
Fieldbus addressing	0 to 99
Service interface	parameterisation via I/O-ASSISTANT
Electrical isolation	fieldbus to operational voltage
<b>Inputs</b>	
Number of channels	8 digital inputs acc. to EN 61131-2
Input voltage	20...29 VDC via operating voltage
Supply current	< 500 mA per channel, short-circuit proof
Low level signal voltage	-3...5 VDC (EN 61131-2, type 2)
High level signal voltage	11...30 VDC (EN 61131-2, type 2)
Input delay	0,2 ms
Max. input current	6 mA
<b>Operating temperature</b>	0 to 55 °C

**Data in process image**

		Bit 7	Bit 6	Bit 5	Bit 4	Bit 3	Bit 2	Bit 1	Bit 0
Input	Byte 0 (M8)	C7P4	C6P4	C5P4	C4P4	C3P4	C2P4	C1P4	C0P4
	Byte 0 (M12)	C3P2	C3P4	C2P2	C2P4	C1P2	C1P4	C0P2	C0P4

C... = Connector No., P... = Pin No.

**piconet® stand-alone module for PROFIBUS-DP**  
**8 digital pnp inputs filter 0.2 ms**

**Device types**

Dimensions	Type	Connection
	<b>6824070 SDPB-0800D-0002</b>	F083, F117, F081
	<b>6824048 SDPB-0800D-0008</b>	F083, F077, F081
	<b>6824407 SDPB-0800D-1008</b>	F084, F077, F081
	<b>6824412 SDPB-0800D-1002</b>	F084, F117, F081

**3**

**Connection**

F083 - Fieldbus M12 x 1

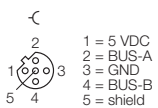

F117 - Input M12 x 1

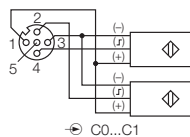

F081 - Voltage supply M8 x 1

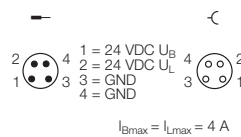

F084 - Fieldbus M12 x 1

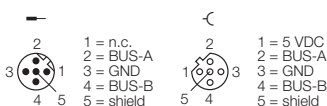

F077 - Input M8 x 1

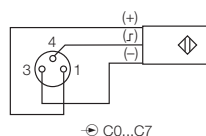

**piconet® stand-alone module for PROFIBUS-DP**  
**8 digital outputs 0.5 A**

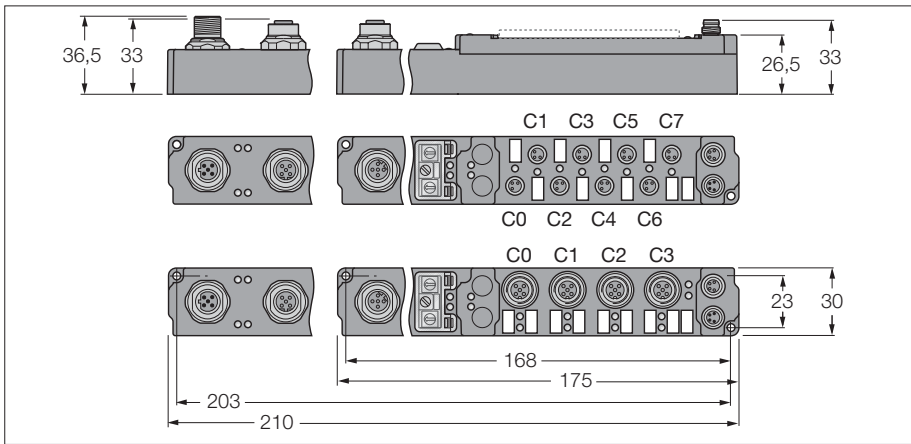

- 8 digital outputs 0.5 A
- Configuration interface
- Parameterisable functions
- Supported via I/O-ASSISTANT
- Direct connection to the fieldbus
- Fibre-glass reinforced PA6 housing
- Encapsulated module electronics
- Metal connector
- Degree of protection IP67

<b>Operating / load voltage</b>	20...29 VDC
Operating current	≤ 90 mA
<b>Fieldbus transmission rate</b>	9.6 kbps up to 12 Mbps
Fieldbus addressing	0 to 99
Service interface	parameterisation via I/O-ASSISTANT
Electrical isolation	fieldbus to operational voltage
<b>Outputs</b>	
Number of channels	8 digital outputs acc. to EN 61131-2
Output voltage	20...29 VDC from load voltage
Output current per channel	0.5 A, short-circuit proof
Load type	resistive, inductive, lamp load
Switching frequency	≤ 500 Hz
Simultaneity factor	1
<b>Operating temperature</b>	0 to 55 °C

**Data in process image**

		Bit 7	Bit 6	Bit 5	Bit 4	Bit 3	Bit 2	Bit 1	Bit 0
<b>Output</b>	<b>Byte 0 (M8)</b>	C7P4	C6P4	C5P4	C4P4	C3P4	C2P4	C1P4	C0P4
	<b>Byte 0 (M12)</b>	C3P2	C3P4	C2P2	C2P4	C1P2	C1P4	C0P2	C0P4

C... = Connector No., P... = Pin No.

**piconet® stand-alone module for PROFIBUS-DP**  
**8 digital outputs 0.5 A**

**Device types**

Dimensions	Type	Connection
	<b>6824061 SDPB-0008D-0001</b>	F083, F118, F081
	<b>6824057 SDPB-0008D-0006</b>	F083, F079, F081
	<b>6824415 SDPB-0008D-1006</b>	F084, F079, F081
	<b>6824416 SDPB-0008D-1001</b>	F084, F118, F081

**3**

**Connection**

F083 - Fieldbus M12 x 1

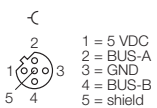

F118 - Output M12 x 1

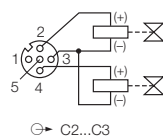

F081 - Voltage supply M8 x 1

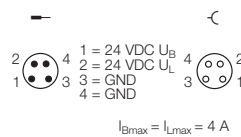

F084 - Fieldbus M12 x 1

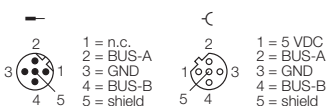

F079 - Output M8 x 1

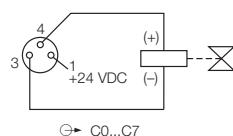

**piconet® stand-alone module for PROFIBUS-DP**  
**8 digital outputs 2 A ( $\Sigma$  4 A)**

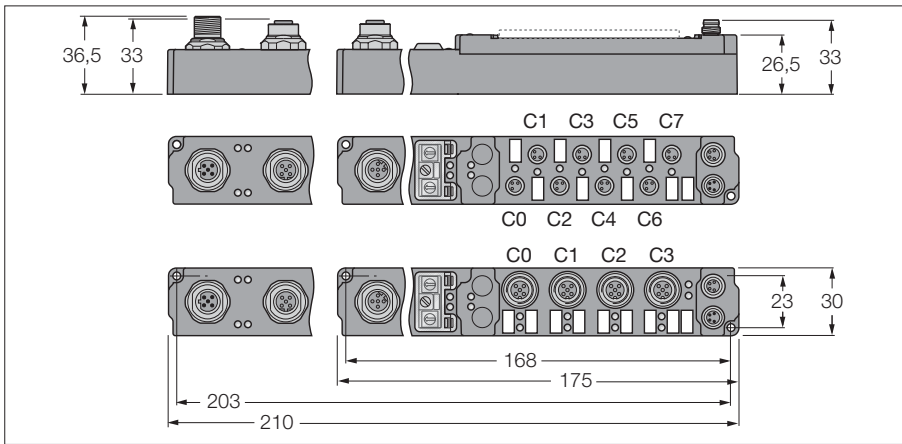

- 8 digital outputs 2 A ( $\Sigma$  = 4 A)
- Configuration interface
- Parameterisable functions
- Supported via I/O-ASSISTANT
- Direct connection to the fieldbus
- Fibre-glass reinforced PA6 housing
- Encapsulated module electronics
- Metal connector
- Degree of protection IP67

<b>Operating / load voltage</b>	20...29 VDC
Operating current	$\leq$ 90 mA
<b>Fieldbus transmission rate</b>	9.6 kbps up to 12 Mbps
Fieldbus addressing	0 to 99
Service interface	parameterisation via I/O-ASSISTANT
Electrical isolation	fieldbus to operational voltage
<b>Outputs</b>	
Number of channels	8 digital outputs acc. to EN 61131-2
Output voltage	20...29 VDC from load voltage
Output current per channel	2 A ( $\Sigma$ 4 A), short-circuit proof
Load type	resistive, inductive, lamp load
Switching frequency	$\leq$ 500 Hz
Simultaneity factor	0.25
<b>Operating temperature</b>	0 to 55 °C

**Data in process image**

		Bit 7	Bit 6	Bit 5	Bit 4	Bit 3	Bit 2	Bit 1	Bit 0
Output	Byte 0 (M8)	C7P4	C6P4	C5P4	C4P4	C3P4	C2P4	C1P4	C0P4
	Byte 0 (M12)	C3P2	C3P4	C2P2	C2P4	C1P2	C1P4	C0P2	C0P4

C... = Connector No., P... = Pin No.



**piconet® stand-alone module for PROFIBUS-DP**  
**8 digital outputs 2 A ( $\Sigma$  4 A)**

**Device types**

Dimensions	Type	Connection
	<b>6824056 SDPB-0008D-0002</b>	F083, F079, F081
	<b>6824063 SDPB-0008D-0003</b>	F083, F118, F081
	<b>6824405 SDPB-0008D-1002</b>	F084, F079, F081
	<b>6824418 SDPB-0008D-1003</b>	F084, F118, F081

3

**Connection**

F083 - Fieldbus M12 x 1

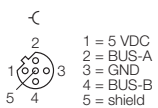

F079 - Output M8 x 1

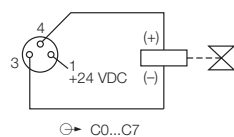

F081 - Voltage supply M8 x 1

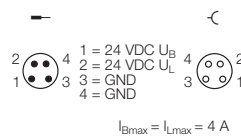

F084 - Fieldbus M12 x 1

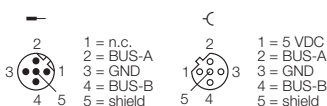

F118 - Output M12 x 1

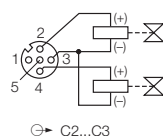

**piconet® stand-alone module for PROFIBUS-DP**  
**8 digital outputs 2 A ( $\Sigma$  12 A)**

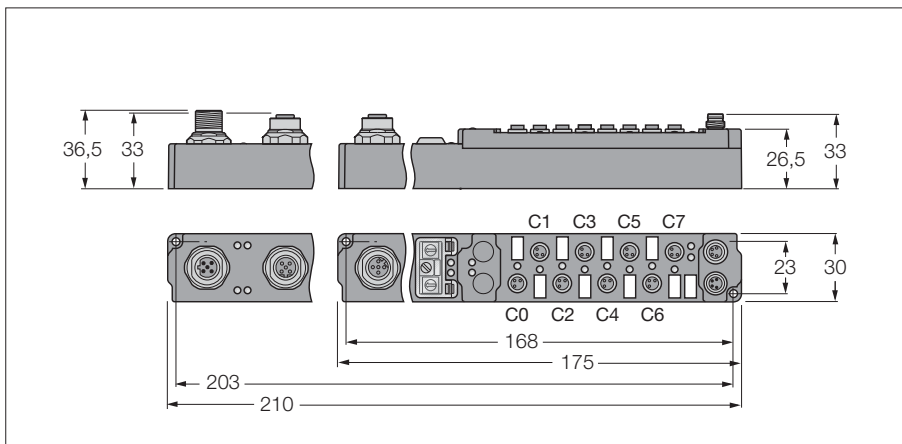

- 8 digital outputs 2 A ( $\Sigma$  = 12 A)
- Total current 12 A I
- Parameterisable functions
- Supported via I/O-ASSISTANT
- Direct connection to the fieldbus
- Fibre-glass reinforced PA6 housing
- Encapsulated module electronics
- Metal connector
- Degree of protection IP67

<b>Operating / load voltage</b>	20...29 VDC
Operating current	$\leq$ 90 mA
<b>Fieldbus transmission rate</b>	9.6 kbps up to 12 Mbps
Fieldbus addressing	0 to 99
Service interface	parameterisation via I/O-ASSISTANT
Electrical isolation	fieldbus to operational voltage
<b>Outputs</b>	
Number of channels	8 digital outputs acc. to EN 61131-2
Output voltage	20...29 VDC from load voltage
Output current per channel	2 A ( $\Sigma$ 12 A), short-circuit proof
Load type	resistive, inductive, lamp load
Switching frequency	$\leq$ 500 Hz
Simultaneity factor	0.75
<b>Operating temperature</b>	0 to 55 °C

**Data in process image**

		Bit 7	Bit 6	Bit 5	Bit 4	Bit 3	Bit 2	Bit 1	Bit 0
<b>Output</b>	<b>Byte 0 (M8)</b>	C7P4	C6P4	C5P4	C4P4	C3P4	C2P4	C1P4	C0P4
	<b>Byte 0 (M12)</b>	C3P2	C3P4	C2P2	C2P4	C1P2	C1P4	C0P2	C0P4

C... = Connector No., P... = Pin No.

**piconet® stand-alone module for PROFIBUS-DP**  
**8 digital outputs 2 A ( $\Sigma$  12 A)**

**Device types**

Dimensions	Type	Connection
	<b>6824064 SDPB-0008D-0004</b>	F083, F079, F082
	<b>6824066 SDPB-0008D-0005</b>	F083, F118, F082
	<b>6824420 SDPB-0008D-1004</b>	F084, F079, F082
	<b>6824421 SDPB-0008D-1005</b>	F084, F118, F082

3

**Connection**

F083 - Fieldbus M12 x 1

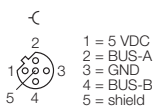

F079 - Output M8 x 1

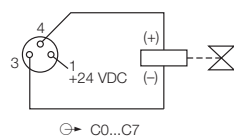

F082 - Voltage supply M8 x 1



F084 - Fieldbus M12 x 1

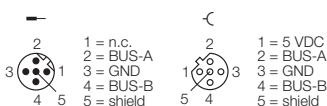

F118 - Output M12 x 1

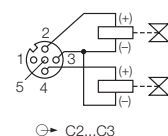

**piconet® stand-alone module for PROFIBUS-DP**  
**4 digital pnp inputs filter 3 ms**  
**4 digital outputs 0.5 A**

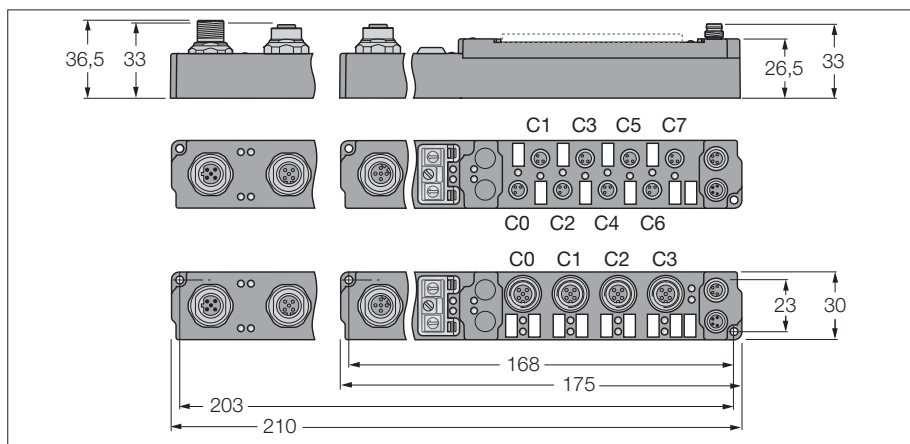

- 4 digital pnp inputs
- 4 digital outputs 0.5 A
- Input filter 3 ms
- Configuration interface
- Parameterisable functions
- Supported via I/O-ASSISTANT
- Direct connection to the fieldbus
- Fibre-glass reinforced PA6 housing
- Encapsulated module electronics
- Metal connector
- Degree of protection IP67

<b>Operating / load voltage</b>	20...29 VDC
Operating current	≤ 90 mA
<b>Fieldbus transmission rate</b>	9.6 kbps up to 12 Mbps
Fieldbus addressing	0 to 99
Service interface	parameterisation via I/O-ASSISTANT
Electrical isolation	fieldbus to operational voltage
<b>Inputs</b>	
Number of channels	4 digital inputs acc. to EN 61131-2
Input voltage	20...29 VDC via operating voltage
Supply current	< 500 mA per channel, short-circuit proof
Low level signal voltage	-3...5 VDC (EN 61131-2, type 2)
High level signal voltage	11...30 VDC (EN 61131-2, type 2)
Input delay	3 ms
Max. input current	6 mA
<b>Outputs</b>	
Number of channels	4 digital outputs acc. to EN 61131-2
Output voltage	20...29 VDC from load voltage
Output current per channel	0.5 A, short-circuit proof
Load type	resistive, inductive, lamp load
Switching frequency	≤ 500 Hz
Simultaneity factor	1
<b>Operating temperature</b>	0 to 55 °C

**Data in process image**

		Bit 7	Bit 6	Bit 5	Bit 4	Bit 3	Bit 2	Bit 1	Bit 0	
The 4 most significant bits are not used, but require memory allocation.	<b>Input</b>	<b>Byte n (M8)</b>	idle	idle	idle	idle	C3P4	C2P4	C1P4	C0P4
		<b>Byte n (M12)</b>	idle	idle	idle	idle	C1P2	C1P4	C0P2	C0P4
	<b>Output</b>	<b>Byte n (M8)</b>	idle	idle	idle	idle	C7P4	C6P4	C5P4	C4P4
		<b>Byte n (M12)</b>	idle	idle	idle	idle	C3P2	C3P4	C2P2	C2P4

C... = Connector no., P... = Pin no.

**piconet® stand-alone module for PROFIBUS-DP**  
**4 digital pnp inputs filter 3 ms**  
**4 digital outputs 0.5 A**

**Device types**

Dimensions	Type	Connection
	<b>6824114 SDPB-0404D-0003</b>	F083, F077, F079, F081
	<b>6824115 SDPB-0404D-0004</b>	F083, F117, F118, F081
	<b>6824423 SDPB-0404D-1003</b>	F084, F077, F079, F081
	<b>6824424 SDPB-0404D-1004</b>	F084, F117, F118, F081

3

**Connection**

F083 - Fieldbus M12 x 1

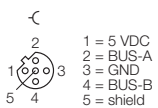

F077 - Input M8 x 1

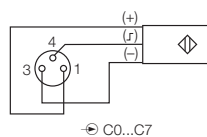

F079 - Output M8 x 1

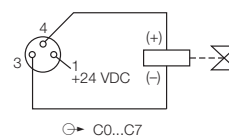

F081 - Voltage supply M8 x 1

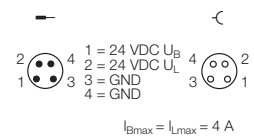

F084 - Fieldbus M12 x 1

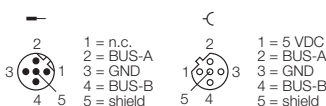

F117 - Input M12 x 1

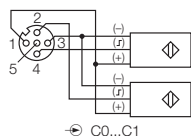

F118 - Output M12 x 1

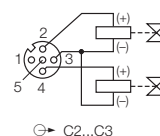

**piconet® stand-alone module for PROFIBUS-DP**  
**4 digital pnp inputs filter 0.2 ms**  
**4 digital outputs 0.5 A**

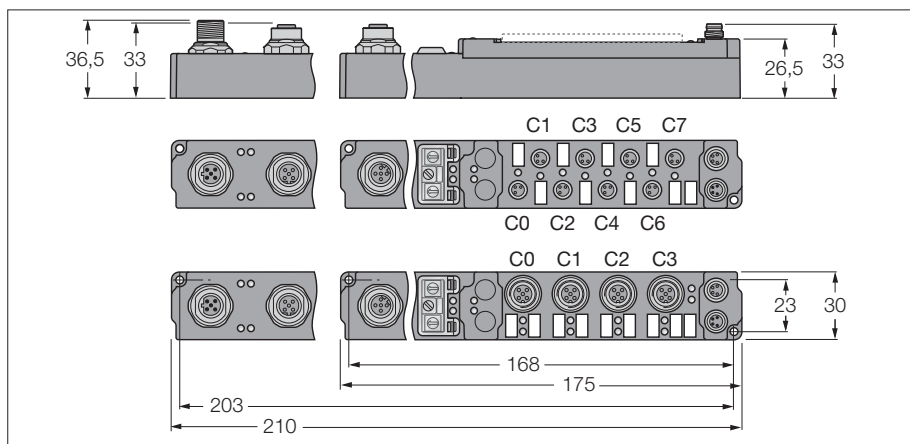

- 4 digital pnp inputs
- 4 digital outputs 0.5 A
- Input filter 0.2 ms
- Configuration interface
- Parameterisable functions
- Supported via I/O-ASSISTANT
- Direct connection to the fieldbus
- Fibre-glass reinforced PA6 housing
- Encapsulated module electronics
- Metal connector
- Degree of protection IP67

<b>Operating / load voltage</b>	20...29 VDC
Operating current	≤ 90 mA
<b>Fieldbus transmission rate</b>	9.6 kbps up to 12 Mbps
Fieldbus addressing	0 to 99
Service interface	parameterisation via I/O-ASSISTANT
Electrical isolation	fieldbus to operational voltage
<b>Inputs</b>	
Number of channels	4 digital inputs acc. to EN 61131-2
Input voltage	20...29 VDC via operating voltage
Supply current	< 500 mA per channel, short-circuit proof
Low level signal voltage	-3...5 VDC (EN 61131-2, type 2)
High level signal voltage	11...30 VDC (EN 61131-2, type 2)
Input delay	0,2 ms
Max. input current	6 mA
<b>Outputs</b>	
Number of channels	4 digital outputs acc. to EN 61131-2
Output voltage	20...29 VDC from load voltage
Output current per channel	0.5 A, short-circuit proof
Load type	resistive, inductive, lamp load
Switching frequency	≤ 500 Hz
Simultaneity factor	1
<b>Operating temperature</b>	0 to 55 °C

**Data in process image**

		Bit 7	Bit 6	Bit 5	Bit 4	Bit 3	Bit 2	Bit 1	Bit 0	
The 4 most significant bits are not used, but require memory allocation.	<b>Input</b>	<b>Byte n (M8)</b>	idle	idle	idle	idle	C3P4	C2P4	C1P4	C0P4
		<b>Byte n (M12)</b>	idle	idle	idle	idle	C1P2	C1P4	C0P2	C0P4
	<b>Output</b>	<b>Byte n (M8)</b>	idle	idle	idle	idle	C7P4	C6P4	C5P4	C4P4
		<b>Byte n (M12)</b>	idle	idle	idle	idle	C3P2	C3P4	C2P2	C2P4

C... = Connector no., P... = Pin no.

**piconet® stand-alone module for PROFIBUS-DP**  
**4 digital pnp inputs filter 0.2 ms**  
**4 digital outputs 0.5 A**

**Device types**

Dimensions	Type	Connection
	<b>6824113 SDPB-0404D-0002</b>	F083, F117, F118, F081
	<b>6824049 SDPB-0404D-0001</b>	F083, F077, F079, F081
	<b>6824426 SDPB-0404D-1001</b>	F084, F077, F079, F081
	<b>6824427 SDPB-0404D-1002</b>	F084, F117, F118, F081

**3**

**Connection**

F083 - Fieldbus M12 x 1

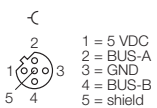

F117 - Input M12 x 1

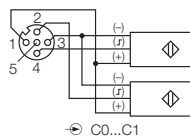

F118 - Output M12 x 1

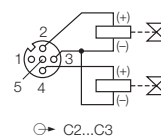

F081 - Voltage supply M8 x 1

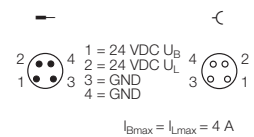

F084 - Fieldbus M12 x 1

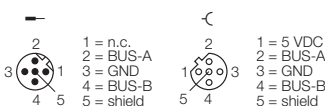

F077 - Input M8 x 1

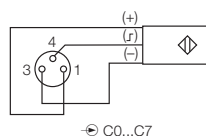

F079 - Output M8 x 1

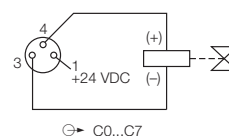

**piconet® stand-alone module for PROFIBUS-DP**  
**4 digital pnp inputs filter 3 ms**  
**4 digital outputs 2 A**

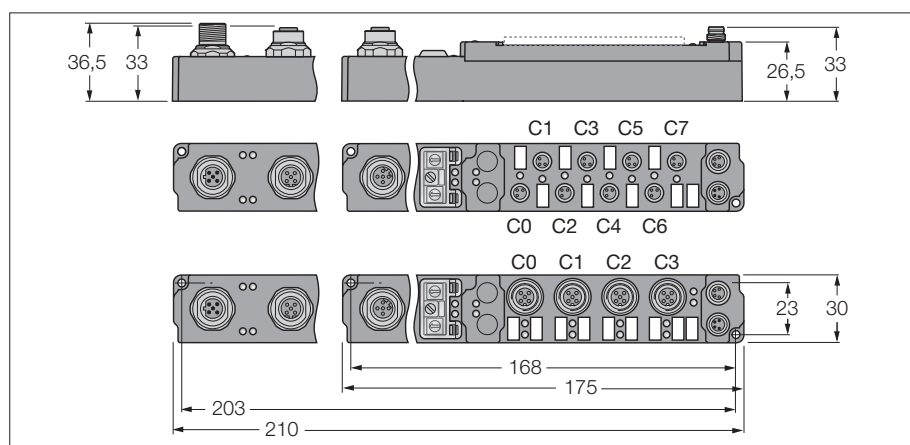

- 4 digital pnp inputs
- 4 digital outputs 2 A
- Input filter 3 ms
- Configuration interface
- Parameterisable functions
- Supported via I/O-ASSISTANT
- Direct connection to the fieldbus
- Fibre-glass reinforced PA6 housing
- Encapsulated module electronics
- Metal connector
- Degree of protection IP67

<b>Operating / load voltage</b>	20...29 VDC
Operating current	≤ 90 mA
<b>Fieldbus transmission rate</b>	9.6 kbps up to 12 Mbps
Fieldbus addressing	0 to 99
Service interface	parameterisation via I/O-ASSISTANT
Electrical isolation	fieldbus to operational voltage
<b>Inputs</b>	
Number of channels	4 digital inputs acc. to EN 61131-2
Input voltage	20...29 VDC via operating voltage
Supply current	< 500 mA per channel, short-circuit proof
Low level signal voltage	-3...5 VDC (EN 61131-2, type 2)
High level signal voltage	11...30 VDC (EN 61131-2, type 2)
Input delay	3 ms
Max. input current	6 mA
<b>Outputs</b>	
Number of channels	4 digital outputs acc. to EN 61131-2
Output voltage	20...29 VDC from load voltage
Output current per channel	2 A (Σ 4 A), short-circuit proof
Load type	resistive, inductive, lamp load
Switching frequency	≤ 500 Hz
Simultaneity factor	0.5
<b>Operating temperature</b>	0 to 55 °C

**Data in process image**

		Bit 7	Bit 6	Bit 5	Bit 4	Bit 3	Bit 2	Bit 1	Bit 0	
The 4 most significant bits are not used, but require memory allocation.	<b>Input</b>	<b>Byte n (M8)</b>	idle	idle	idle	idle	C3P4	C2P4	C1P4	C0P4
		<b>Byte n (M12)</b>	idle	idle	idle	idle	C1P2	C1P4	C0P2	C0P4
	<b>Output</b>	<b>Byte n (M8)</b>	idle	idle	idle	idle	C7P4	C6P4	C5P4	C4P4
		<b>Byte n (M12)</b>	idle	idle	idle	idle	C3P2	C3P4	C2P2	C2P4

C... = Connector no., P... = Pin no.



**piconet® stand-alone module for PROFIBUS-DP**  
**4 digital pnp inputs filter 3 ms**  
**4 digital outputs 2 A**

**Device types**

Dimensions	Type	Connection
	<b>6824119 SDPB-0404D-0007</b>	F083, F077, F079, F081
	<b>6824111 SDPB-0404D-0008</b>	F083, F117, F118, F081
	<b>6824429 SDPB-0404D-1007</b>	F084, F077, F079, F081
	<b>6824430 SDPB-0404D-1008</b>	F084, F117, F118, F081

3

**Connection**

F083 - Fieldbus M12 x 1

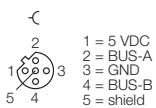

F077 - Input M8 x 1

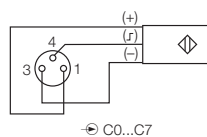

F079 - Output M8 x 1

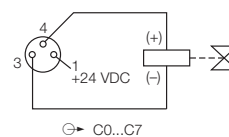

F081 - Voltage supply M8 x 1

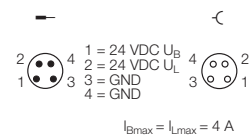

F084 - Fieldbus M12 x 1

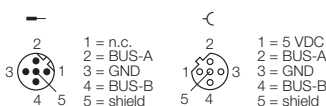

F117 - Input M12 x 1

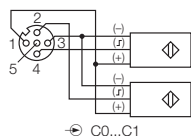

F118 - Output M12 x 1

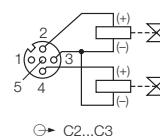

**piconet® stand-alone module for PROFIBUS-DP**  
**4 digital pnp inputs filter 0.2 ms**  
**4 digital outputs 2 A**

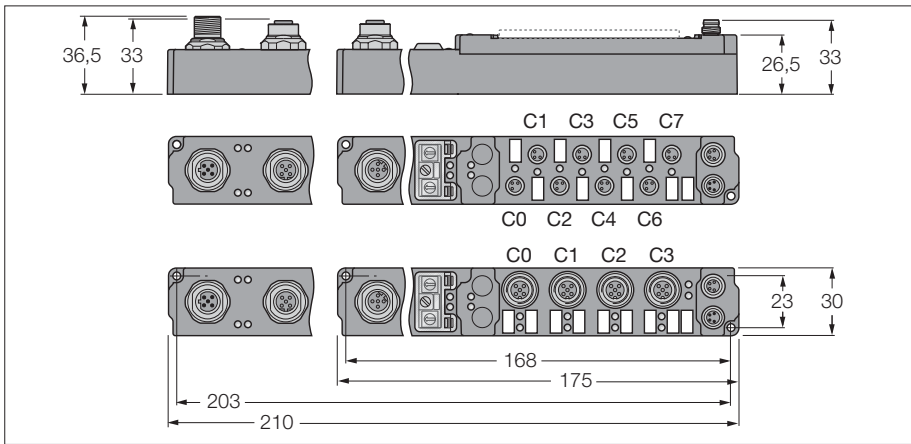

- 4 digital pnp inputs
- 4 digital outputs 2 A
- Input filter 0.2 ms
- Configuration interface
- Parameterisable functions
- Supported via I/O-ASSISTANT
- Direct connection to the fieldbus
- Fibre-glass reinforced PA6 housing
- Encapsulated module electronics
- Metal connector
- Degree of protection IP67

<b>Operating / load voltage</b>	20...29 VDC
Operating current	≤ 90 mA
<b>Fieldbus transmission rate</b>	9.6 kbps up to 12 Mbps
Fieldbus addressing	0 to 99
Service interface	parameterisation via I/O-ASSISTANT
Electrical isolation	fieldbus to operational voltage
<b>Inputs</b>	
Number of channels	4 digital inputs acc. to EN 61131-2
Input voltage	20...29 VDC via operating voltage
Supply current	< 500 mA per channel, short-circuit proof
Low level signal voltage	-3...5 VDC (EN 61131-2, type 2)
High level signal voltage	11...30 VDC (EN 61131-2, type 2)
Input delay	0,2 ms
Max. input current	6 mA
<b>Outputs</b>	
Number of channels	4 digital outputs acc. to EN 61131-2
Output voltage	20...29 VDC from load voltage
Output current per channel	2 A (Σ 4 A), short-circuit proof
Load type	resistive, inductive, lamp load
Switching frequency	≤ 500 Hz
Simultaneity factor	0.5
<b>Operating temperature</b>	0 to 55 °C

**Data in process image**

		Bit 7	Bit 6	Bit 5	Bit 4	Bit 3	Bit 2	Bit 1	Bit 0	
The 4 most significant bits are not used, but require memory allocation.	<b>Input</b>	<b>Byte n (M8)</b>	idle	idle	idle	idle	C3P4	C2P4	C1P4	C0P4
		<b>Byte n (M12)</b>	idle	idle	idle	idle	C1P2	C1P4	C0P2	C0P4
	<b>Output</b>	<b>Byte n (M8)</b>	idle	idle	idle	idle	C7P4	C6P4	C5P4	C4P4
		<b>Byte n (M12)</b>	idle	idle	idle	idle	C3P2	C3P4	C2P2	C2P4

C... = Connector no., P... = Pin no.

**piconet® stand-alone module for PROFIBUS-DP**  
**4 digital pnp inputs filter 0.2 ms**  
**4 digital outputs 2 A**

**Device types**

Dimensions	Type	Connection
	<b>6824118 SDPB-0404D-0006</b>	F083, F117, F118, F081
	<b>6824116 SDPB-0404D-0005</b>	F083, F077, F079, F081
	<b>6824432 SDPB-0404D-1005</b>	F084, F077, F079, F081
	<b>6824433 SDPB-0404D-1006</b>	F084, F117, F118, F081

**3**

**Connection**

F083 - Fieldbus M12 x 1

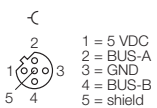

F117 - Input M12 x 1

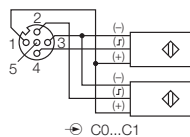

F118 - Output M12 x 1

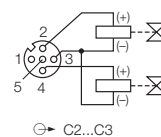

F081 - Voltage supply M8 x 1

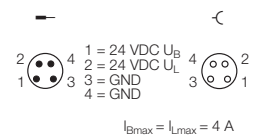

F084 - Fieldbus M12 x 1

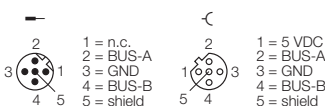

F077 - Input M8 x 1

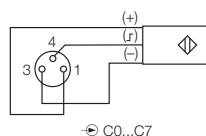

F079 - Output M8 x 1

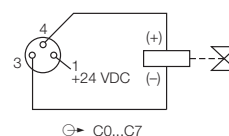

**piconet® stand-alone module for PROFIBUS-DP**  
**8 digital pnp inputs filter 3 ms**  
**8 digital outputs 0.5 A**

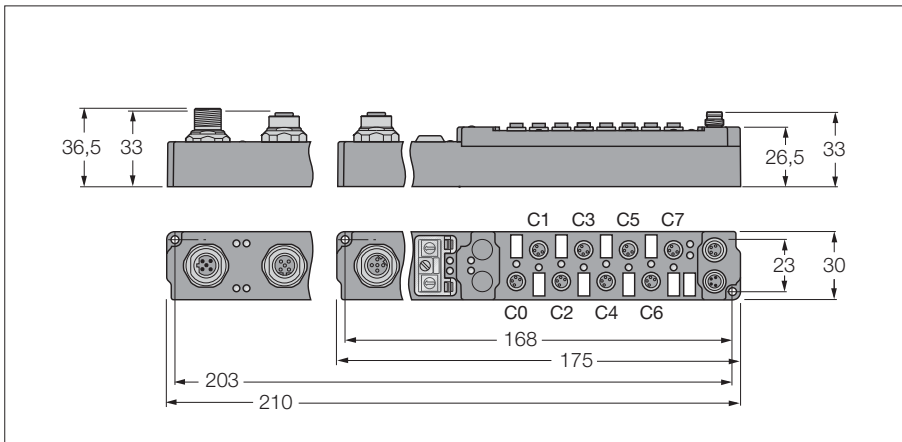

- 8 digital pnp inputs
- 8 digital outputs 0.5 A
- Input filter 3 ms
- Configuration interface
- Parameterisable functions
- Supported via I/O-ASSISTANT
- Direct connection to the fieldbus
- Fibre-glass reinforced PA6 housing
- Encapsulated module electronics
- Metal connector
- Degree of protection IP67

<b>Operating / load voltage</b>	20...29 VDC
Operating current	≤ 90 mA
<b>Fieldbus transmission rate</b>	9.6 kbps up to 12 Mbps
Fieldbus addressing	0 to 99
Service interface	parameterisation via I/O-ASSISTANT
Electrical isolation	fieldbus to operational voltage
<b>Inputs</b>	
Number of channels	8 digital inputs acc. to EN 61131-2
Input voltage	20...29 VDC via operating voltage
Supply current	< 500 mA per channel, short-circuit proof
Low level signal voltage	-3...5 VDC (EN 61131-2, type 2)
High level signal voltage	11...30 VDC (EN 61131-2, type 2)
Input delay	3 ms
Max. input current	6 mA
<b>Outputs</b>	
Number of channels	8 digital outputs acc. to EN 61131-2
Output voltage	20...29 VDC from load voltage
Output current per channel	0.5 A, short-circuit proof
Load type	resistive, inductive, lamp load
Switching frequency	≤ 500 Hz
Simultaneity factor	1
<b>Operating temperature</b>	0 to 55 °C

**Data in process image**

			Bit 7	Bit 6	Bit 5	Bit 4	Bit 3	Bit 2	Bit 1	Bit 0
Each 1 byte input data is mapped.	<b>Input</b>	<b>Byte 0 (M8)</b>	C7P4	C6P4	C5P4	C4P4	C3P4	C2P4	C1P4	C0P4
Each 1 byte output data is mapped.	<b>Output</b>	<b>Byte 0 (M8)</b>	C7P2	C6P2	C5P2	C4P2	C3P2	C2P2	C1P2	C0P2

C... = Connector no. – P... = Pin no.

**piconet® stand-alone module for PROFIBUS-DP**  
**8 digital pnp inputs filter 3 ms**  
**8 digital outputs 0.5 A**

**Device types**

Dimensions	Type	Connection
	<b>6824167 SDPB-0808D-0001</b>	F083, F075, F078, F081
	<b>6824435 SDPB-0808D-1001</b>	F084, F075, F078, F081

**3**

**Connection**

F083 - Fieldbus M12 x 1

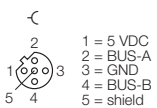

F075 - Input M8 x 1

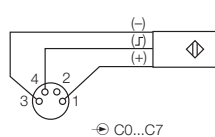

F081 - Voltage supply M8 x 1

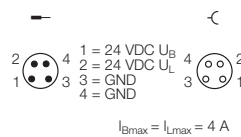

F084 - Fieldbus M12 x 1

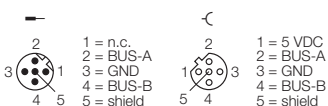

F078 - Output M8 x 1

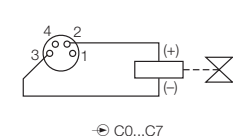

**piconet® stand-alone module for PROFIBUS-DP**  
**4 analogue inputs ±10 V**

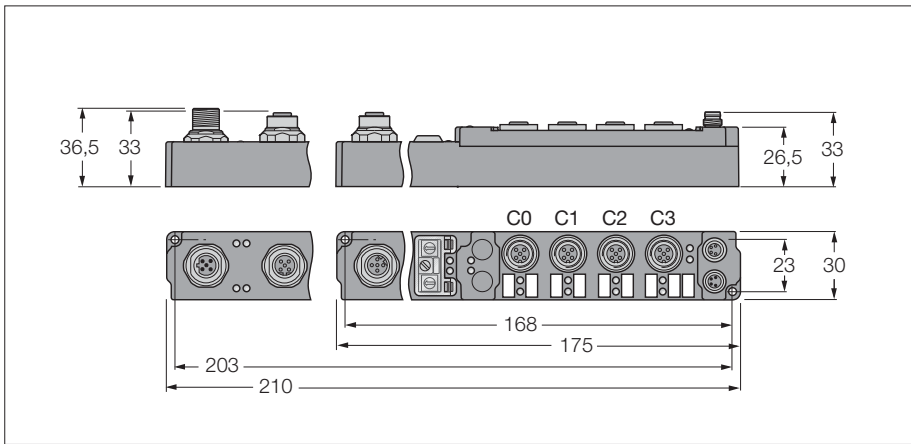

- 4 analogue inputs ±10 V
- Configuration interface
- Parameterisable functions
- Supported via I/O-ASSISTANT
- Direct connection to the fieldbus
- Fibre-glass reinforced PA6 housing
- Encapsulated module electronics
- Metal connector
- Degree of protection IP67

<b>Operating / load voltage</b>	20...29 VDC
Operating current	≤ 140 mA
<b>Fieldbus transmission rate</b>	9.6 kbps up to 12 Mbps
Fieldbus addressing	0 to 99
Service interface	parameterisation via I/O-ASSISTANT
Electrical isolation	fieldbus to operational voltage
<b>Inputs</b>	
Number of channels	4 analogue inputs ± 10 V
Input resistance	> 100 Ω
Electrical isolation	channels to operational voltage
<b>Common mode voltage</b>	
Measuring current	max. 35 V
Conversion time	0.5 mA
Relative measuring error	250 ms
Input filter	< +/- 0.3 % of full scale
Sensor supply	variable
<b>Operating temperature</b>	from load voltage
	0 to 55 °C

**Data in process image**

Valid for the setting "Motorola format"

SBn: Status byte channel n  
 CBn: Control byte channel n  
 Chn D0: channel n, least significant data byte  
 Chn D1: channel n, most significant data byte

Pre-conditions	Address	Input data		Output data	
	Word	High-Byte	Low-Byte	High-Byte	Low-Byte
<b>Compact mapping:</b> Starting with Ch0 D1 in "Low-Byte" word 0 all other bytes follow immediately. Only the user data are mapped (greyed in the table). <b>Complex mapping:</b> Data are mapped with control and status byte.	0	Ch0 D1	SB0	Ch0 D1	CB0
	1	SB1	Ch0 D0	CB1	Ch0 D0
	2	Ch1 D0	Ch1 D1	Ch1 D0	Ch1 D1
	3	Ch2 D1	SB2	Ch2 D1	CB2
	4	SB3	Ch2 D0	CB3	Ch2 D0
	5	Ch3 D0	Ch3 D1	Ch3 D0	Ch3 D1

**piconet® stand-alone module for PROFIBUS-DP**  
**4 analogue inputs ±10 V**

**Device types**

Dimensions	Type	Connection
	<b>6824051 SDPB-40A-0005</b>	F083, F087, F124, F091
	<b>6824438 SDPB-40A-1005</b>	F084, F087, F124, F091

**Connection**

F083 - Fieldbus M12 x 1

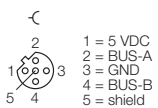

F087 - Input M12 x 1

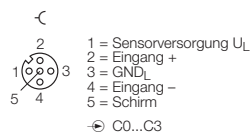

F091 - Voltage supply M8 x 1

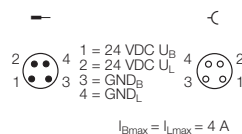

F084 - Fieldbus M12 x 1

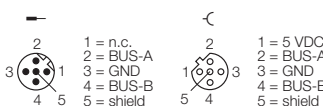

F124 - Connection - inputs

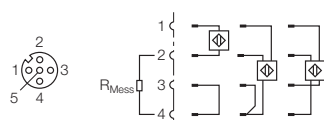

**piconet® stand-alone module for PROFIBUS-DP**  
**4 analogue inputs 0(4)... 20 mA**

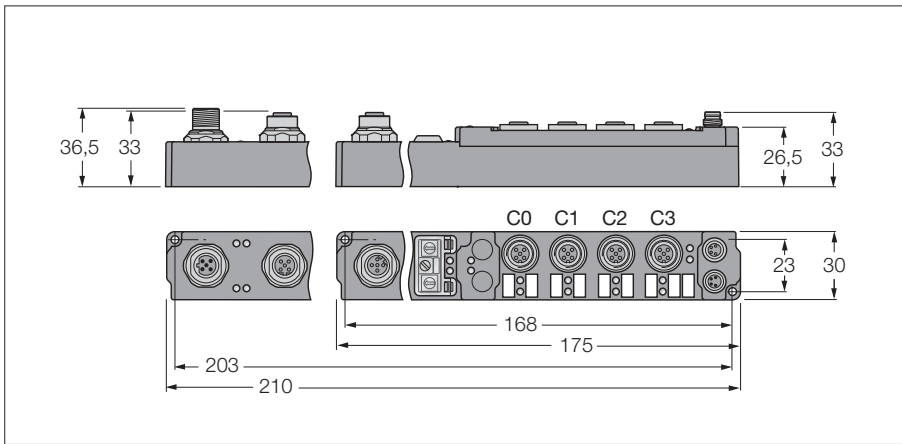

- 4 analogue inputs 0(4)...20 mA
- Configuration interface
- Parameterisable functions
- Supported via I/O-ASSISTANT
- Direct connection to the fieldbus
- Fibre-glass reinforced PA6 housing
- Encapsulated module electronics
- Metal connector
- Degree of protection IP67

<b>Operating / load voltage</b>	20...29 VDC
Operating current	≤ 140 mA
<b>Fieldbus transmission rate</b>	9.6 kbps up to 12 Mbps
Fieldbus addressing	0 to 99
Service interface	parameterisation via I/O-ASSISTANT
Electrical isolation	fieldbus to operational voltage
<b>Inputs</b>	
Number of channels	4 analogue inputs 20 mA
Input resistance	80 Ω
Electrical isolation	channels to operational voltage
<b>Common mode voltage</b>	
Measuring current	max. 35 V
Conversion time	0.5 mA
Relative measuring error	250 ms
Input filter	< +/- 0.3 % of full scale
Sensor supply	variable
<b>Operating temperature</b>	from load voltage
	0 to 55 °C

**Data in process image**

Valid for the setting "Motorola format"

SBn: Status byte channel n  
 CBn: Control byte channel n  
 Chn D0: channel n,  
 least significant data byte  
 Chn D1: channel n,  
 most significant data byte

Pre-conditions	Address	Input data		Output data	
	Word	High-Byte	Low-Byte	High-Byte	Low-Byte
<b>Compact mapping:</b> Starting with Ch0 D1 in "Low-Byte" word 0 all other bytes follow immediately. Only the user data are mapped (greyed in the table). <b>Complex mapping:</b> Data are mapped with control and status byte.	0	Ch0 D1	SB0	Ch0 D1	CB0
	1	SB1	Ch0 D0	CB1	Ch0 D0
	2	Ch1 D0	Ch1 D1	Ch1 D0	Ch1 D1
	3	Ch2 D1	SB2	Ch2 D1	CB2
	4	SB3	Ch2 D0	CB3	Ch2 D0
	5	Ch3 D0	Ch3 D1	Ch3 D0	Ch3 D1



**piconet® stand-alone module for PROFIBUS-DP**  
**4 analogue inputs 0(4)... 20 mA**

**Device types**

Dimensions	Type	Connection
	<b>6824052 SDPB-40A-0007</b>	F083, F087, F124, F091
	<b>6824439 SDPB-40A-1007</b>	F084, F087, F124, F091

**3**

**Connection**

F083 - Fieldbus M12 x 1

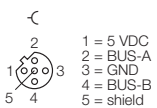

F087 - Input M12 x 1

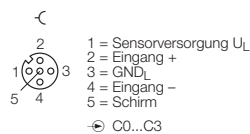

F091 - Voltage supply M8 x 1

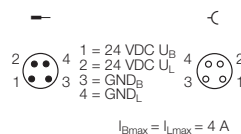

F084 - Fieldbus M12 x 1

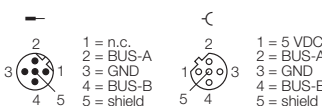

F124 - Connection - inputs

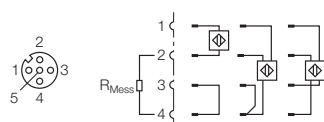

## **piconet® stand-alone module for PROFIBUS-DP** **4 analogue inputs for Pt100**

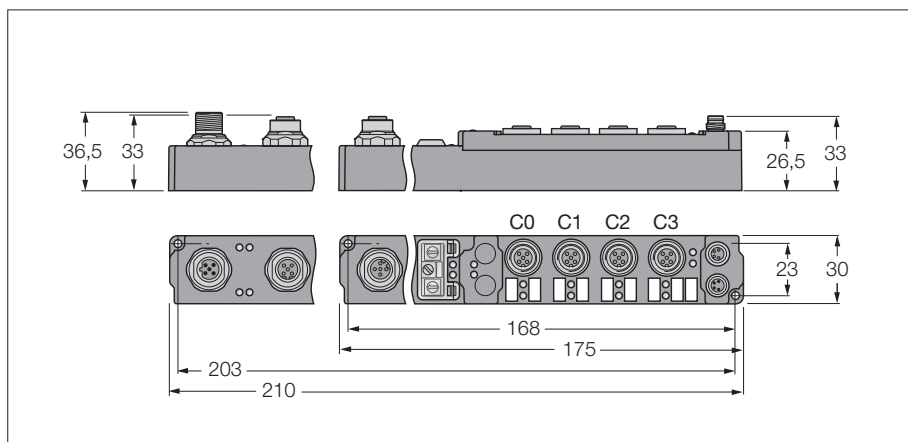

- 4 analogue inputs for Pt100
- Configuration interface
- Parameterisable functions
- Supported via I/O-ASSISTANT
- Direct connection to the fieldbus
- Fibre-glass reinforced PA6 housing
- Encapsulated module electronics
- Metal connector
- Degree of protection IP67

<b>Operating / load voltage</b>	20...29 VDC
Operating current	≤ 110 mA
<b>Fieldbus transmission rate</b>	9.6 kbps up to 12 Mbps
Fieldbus addressing	0 to 99
Service interface	parameterisation via I/O-ASSISTANT
Electrical isolation	fieldbus to operational voltage
<b>Inputs</b>	
Number of channels	4 analogue inputs Pt100
Electrical isolation	channels to operational voltage
<b>Sensor type</b>	
Temperature range	Pt100 -200 to 850 °C (Pt sensors), -60 to 250 °C (Ni sensors)
<b>Measuring current</b>	
Conversion time	0.1 °C 250 ms
Relative measuring error	< +-1.0 % of full scale
Input filter	variable
Sensor supply	from operational voltage
<b>Operating temperature</b>	0 to 55 °C

### Data in process image

Valid for the setting "Motorola format"

SBn: Status byte channel n  
CBn: Control byte channel n  
Chn D0: channel n,  
least significant data byte  
Chn D1: channel n,  
most significant data byte

Pre-conditions	Address	Input data		Output data	
	Word	High-Byte	Low-Byte	High-Byte	Low-Byte
<b>Compact mapping:</b> Starting with Ch0 D1 in "Low-Byte" word 0 all other bytes follow immediately. Only the user data are mapped (greyed in the table). <b>Complex mapping:</b> Data are mapped with control and status byte.	0	Ch0 D1	SB0	Ch0 D1	CB0
	1	SB1	Ch0 D0	CB1	Ch0 D0
	2	Ch1 D0	Ch1 D1	Ch1 D0	Ch1 D1
	3	Ch2 D1	SB2	Ch2 D1	CB2
	4	SB3	Ch2 D0	CB3	Ch2 D0
5	Ch3 D0	Ch3 D1	Ch3 D0	Ch3 D1	

**piconet® stand-alone module for PROFIBUS-DP**  
**4 analogue inputs for Pt100**

**Device types**

Dimensions	Type	Connection
	<b>6824040 SDPB-40A-0009</b>	F083, F088, F125, F091
	<b>6824440 SDPB-40A-1009</b>	F084, F088, F125, F091

**Connection**

F083 - Fieldbus M12 x 1

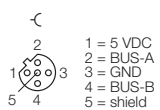

F088 - Input M12 x 1

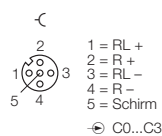

F091 - Voltage supply M8 x 1

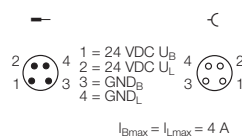

F084 - Fieldbus M12 x 1

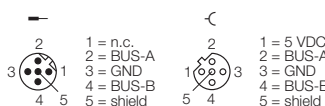

F125 - Connection - inputs

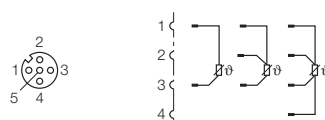

**piconet® stand-alone module for PROFIBUS-DP**  
**4 analogue inputs for thermoelements**

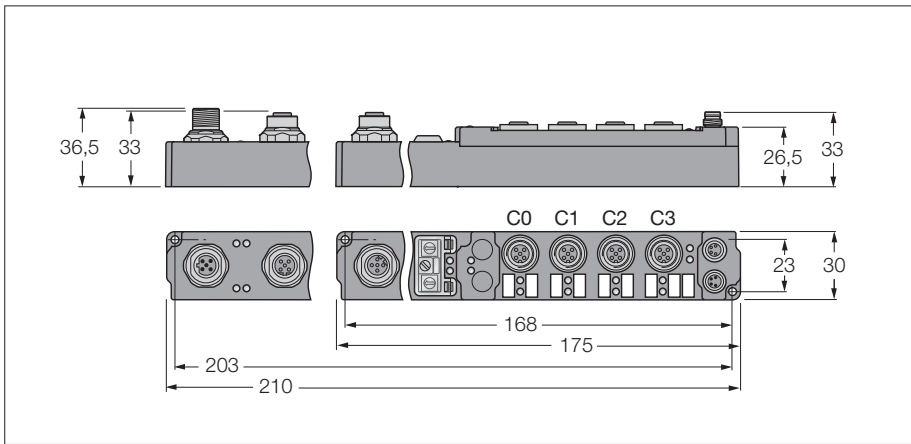

- 4 analogue inputs for thermoelements
- Configuration interface
- Parameterisable functions
- Supported via I/O-ASSISTANT
- Direct connection to the fieldbus
- Fibre-glass reinforced PA6 housing
- Encapsulated module electronics
- Metal connector
- Degree of protection IP67

<b>Operating / load voltage</b>	20...29 VDC
Operating current	≤ 110 mA
<b>Fieldbus transmission rate</b>	9.6 kbps up to 12 Mbps
Fieldbus addressing	0 to 99
Service interface	parameterisation via I/O-ASSISTANT
Electrical isolation	fieldbus to operational voltage
<b>Inputs</b>	
Number of channels	4 analogue thermoelement inputs
Electrical isolation	channels to operational voltage
<b>Sensor type</b>	
Temperature range	Sensor sensor (default type K)
<b>Conversion time</b>	
Relative measuring error	< +/-0.5 % of full scale
Input filter	variable
Sensor supply	from operational voltage
<b>Operating temperature</b>	0 to 55 °C

**Data in process image**

Valid for the setting "Motorola format"

SBn: Status byte channel n  
 CBn: Control byte channel n  
 Chn D0: channel n,  
 least significant data byte  
 Chn D1: channel n,  
 most significant data byte

Pre-conditions	Address	Input data		Output data	
	Word	High-Byte	Low-Byte	High-Byte	Low-Byte
<b>Compact mapping:</b> Starting with Ch0 D1 in "Low-Byte" word 0 all other bytes follow immediately. Only the user data are mapped (greyed in the table). <b>Complex mapping:</b> Data are mapped with control and status byte.	0	Ch0 D1	SB0	Ch0 D1	CB0
	1	SB1	Ch0 D0	CB1	Ch0 D0
	2	Ch1 D0	Ch1 D1	Ch1 D0	Ch1 D1
	3	Ch2 D1	SB2	Ch2 D1	CB2
	4	SB3	Ch2 D0	CB3	Ch2 D0
	5	Ch3 D0	Ch3 D1	Ch3 D0	Ch3 D1

**piconet® stand-alone module for PROFIBUS-DP**  
**4 analogue inputs for thermoelements**

**Device types**

Dimensions	Type	Connection
	<b>6824050 SDPB-40A-0004</b>	F083, F086, F126, F091
	<b>6824441 SDPB-40A-1004</b>	F084, F086, F126, F091

**Connection**

F083 - Fieldbus M12 x 1

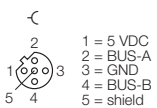

F086 - Input M12 x 1

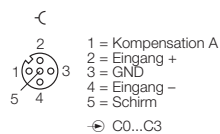

F091 - Voltage supply M8 x 1

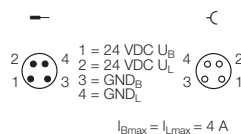

F084 - Fieldbus M12 x 1

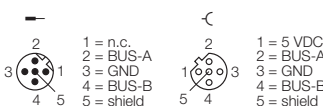

F126 - Connection - inputs

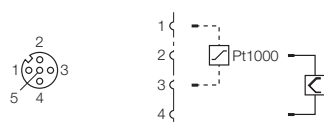

**piconet® stand-alone module for PROFIBUS-DP**  
**4 analogue outputs ±10 V**

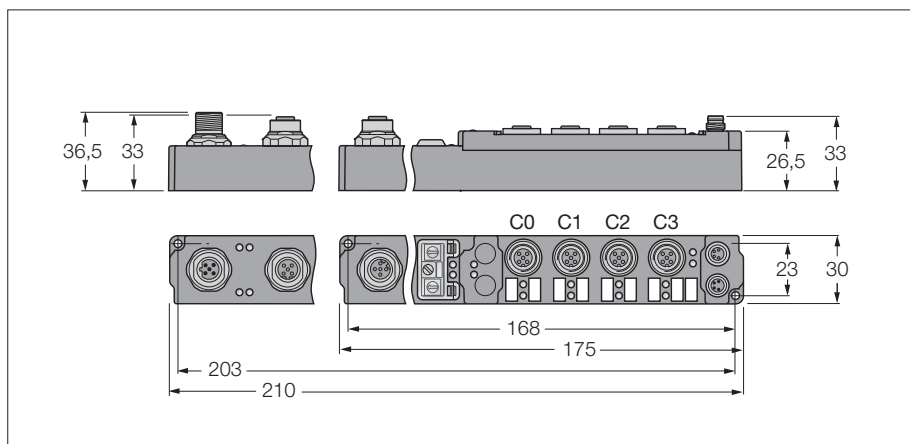

- 4 analogue outputs ±10 V
- Configuration interface
- Parameterisable functions
- Supported via I/O-ASSISTANT
- Direct connection to the fieldbus
- Fibre-glass reinforced PA6 housing
- Encapsulated module electronics
- Metal connector
- Degree of protection IP67

<b>Operating / load voltage</b>	20...29 VDC
Operating current	≤ 140 mA
<b>Fieldbus transmission rate</b>	9.6 kbps up to 12 Mbps
Fieldbus addressing	0 to 99
Service interface	parameterisation via I/O-ASSISTANT
Electrical isolation	fieldbus to operational voltage
<b>Outputs</b>	
Number of channels	4 analogue outputs ± 10 V
Load resistance	> 5000 Ω
Electrical isolation	channels to operational voltage
<b>Conversion time</b>	< 1 ms
Relative measuring error	< +- 0.3 % of full scale
Actuator power supply	from load voltage
<b>Operating temperature</b>	0 to 55 °C

**Data in process image**

Valid for the setting "Motorola format"

SBn: Status byte channel n  
 CBn: Control byte channel n  
 Chn D0: channel n,  
 least significant data byte  
 Chn D1: channel n,  
 most significant data byte

Pre-conditions	Address	Input data		Output data	
	Word	High-Byte	Low-Byte	High-Byte	Low-Byte
<b>Compact mapping:</b> Starting with Ch0 D1 in "Low-Byte" word 0 all other bytes follow immediately. Only the user data are mapped (greyed in the table). <b>Complex mapping:</b> Data are mapped with control and status byte.	0	Ch0 D1	SB0	Ch0 D1	CB0
	1	SB1	Ch0 D0	CB1	Ch0 D0
	2	Ch1 D0	Ch1 D1	Ch1 D0	Ch1 D1
	3	Ch2 D1	SB2	Ch2 D1	CB2
	4	SB3	Ch2 D0	CB3	Ch2 D0
	5	Ch3 D0	Ch3 D1	Ch3 D0	Ch3 D1

**piconet® stand-alone module for PROFIBUS-DP**  
**4 analogue outputs ±10 V**

**Device types**

Dimensions	Type	Connection
	<b>6824069 SDPB-04A-0007</b>	F083, F127, F128, F091
	<b>6824443 SDPB-04A-1007</b>	F084, F127, F128, F091

**3**

**Connection**

F083 - Fieldbus M12 x 1

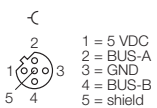

F127 - Output M12 x 1

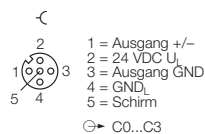

F091 - Voltage supply M8 x 1

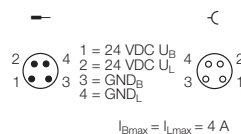

F084 - Fieldbus M12 x 1

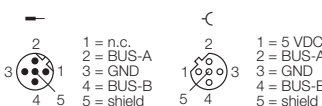

F128 - Connection - outputs

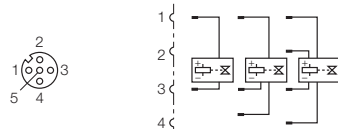

**piconet® stand-alone module for PROFIBUS-DP**  
**4 analogue outputs 0...20 mA**

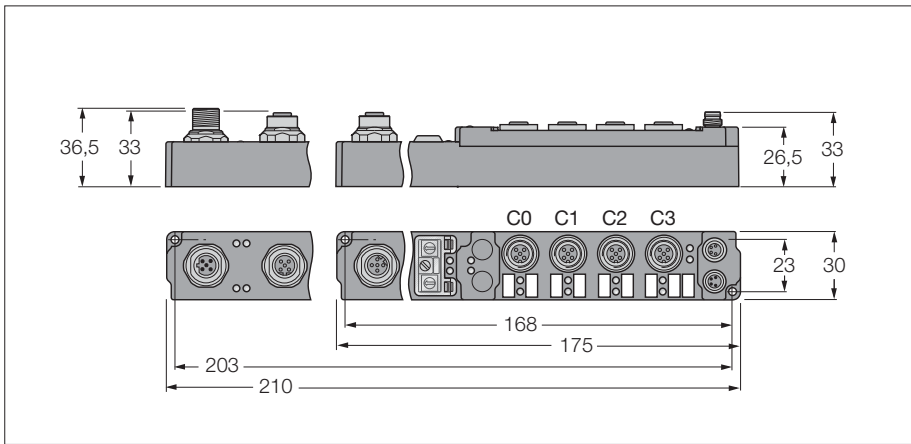

- 4 analogue outputs 0(4)...20 mA
- Configuration interface
- Parameterisable functions
- Supported via I/O-ASSISTANT
- Direct connection to the fieldbus
- Fibre-glass reinforced PA6 housing
- Encapsulated module electronics
- Metal connector
- Degree of protection IP67

<b>Operating / load voltage</b>	20...29 VDC
Operating current	≤ 115 mA
<b>Fieldbus transmission rate</b>	9.6 kbps up to 12 Mbps
Fieldbus addressing	0 to 99
Service interface	parameterisation via I/O-ASSISTANT
Electrical isolation	fieldbus to operational voltage
<b>Outputs</b>	
Number of channels	4 analogue outputs 20 mA
Load resistance	< 500 Ω
Electrical isolation	channels to operational voltage
<b>Conversion time</b>	< 3,5 ms
Relative measuring error	< +- 0.3 % of full scale
Actuator power supply	from load voltage
<b>Operating temperature</b>	0 to 55 °C

**Data in process image**

Valid for the setting "Motorola format"

SBn: Status byte channel n  
 CBn: Control byte channel n  
 Chn D0: channel n,  
 least significant data byte  
 Chn D1: channel n,  
 most significant data byte

Pre-conditions	Address	Input data		Output data	
	Word	High-Byte	Low-Byte	High-Byte	Low-Byte
<b>Compact mapping:</b> Starting with Ch0 D1 in "Low-Byte" word 0 all other bytes follow immediately. Only the user data are mapped (greyed in the table). <b>Complex mapping:</b> Data are mapped with control and status byte.	0	Ch0 D1	SB0	Ch0 D1	CB0
	1	SB1	Ch0 D0	CB1	Ch0 D0
	2	Ch1 D0	Ch1 D1	Ch1 D0	Ch1 D1
	3	Ch2 D1	SB2	Ch2 D1	CB2
	4	SB3	Ch2 D0	CB3	Ch2 D0
	5	Ch3 D0	Ch3 D1	Ch3 D0	Ch3 D1



**piconet® stand-alone module for PROFIBUS-DP**  
**4 analogue outputs 0...20 mA**

**Device types**

Dimensions	Type	Connection
	<b>6824059 SDPB-04A-0009</b>	F083, F127, F128, F091
	<b>6824442 SDPB-04A-1009</b>	F084, F127, F128, F091

**Connection**

F083 - Fieldbus M12 x 1

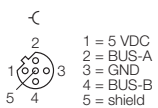

F127 - Output M12 x 1

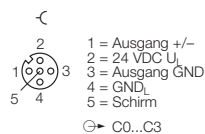

F091 - Voltage supply M8 x 1

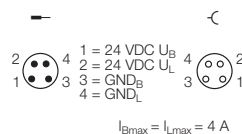

F084 - Fieldbus M12 x 1

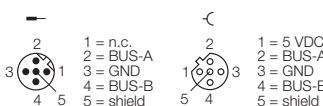

F128 - Connection - outputs

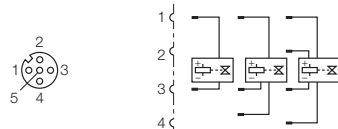

## **piconet® stand-alone module for PROFIBUS-DP 2-channel pulse width modulation (PWM)**

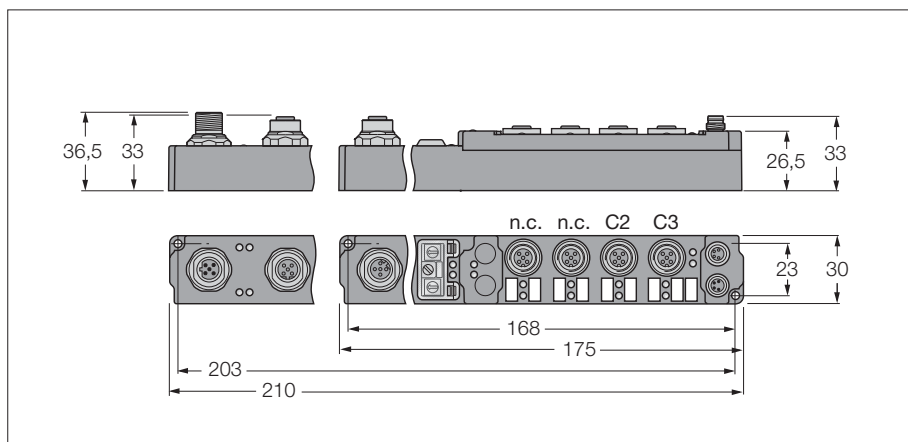

- Pulse width modulation
- 2-channel
- 2.5 A per channel
- Configuration interface
- Parameterisable functions
- Supported via I/O-ASSISTANT
- Direct connection to the fieldbus
- Fibre-glass reinforced PA6 housing
- Encapsulated module electronics
- Metal connector
- Degree of protection IP67

<b>Operating / load voltage</b>	20...29 VDC
Operating current	≤ 85 mA
<b>Fieldbus transmission rate</b>	9.6 kbps up to 12 Mbps
Fieldbus addressing	0 to 99
Service interface	parameterisation via I/O-ASSISTANT
Electrical isolation	fieldbus to operational voltage
<b>V/R output</b>	0.5 A short-circuit proof
Output current per channel	2.5
Load type	resistive, inductive
<b>Base frequency</b>	1 Hz...10 kHz (default 250 Hz)
Duty factor	0...100 % (t ON > 750 ns, t OFF > 500 ns)
Resolution	10 Bit
Freewheeling diode	on the outputs
<b>Operating temperature</b>	0 to 55 °C

### Data in process image

Pre-conditions	Address		Input data		Output data	
	Word	High-Byte	Low-Byte	High-Byte	Low-Byte	
<b>Complex mapping:</b> Data are mapped with control and status byte	0	Ch0 Reg1	SB0	Ch0 D1	CB0	
	1	SB1	Ch0 Reg0	CB1	Ch0 D0	
	2	Ch1 Reg0	Ch1 Reg1	Ch1 D0	Ch1 D1	

**piconet® stand-alone module for PROFIBUS-DP  
2-channel pulse width modulation (PWM)**

**Device types**

Dimensions	Type	Connection
	<b>6824060 SDPB-0002D-0002</b>	F083, F092, F081
	<b>6824437 SDPB-0002D-1002</b>	F084, F092, F081

**Connection**

F083 - Fieldbus M12 x 1

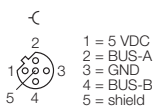

F092 - Output M12 x 1

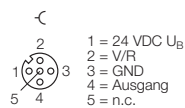

F084 - Fieldbus M12 x 1

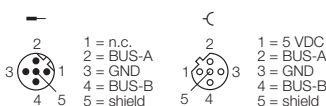

F081 - Voltage supply M8 x 1

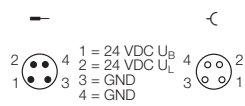

$I_{Bmax} = I_{Lmax} = 4 A$

## **piconet® stand-alone module for PROFIBUS-DP** **2-channel up/down counter**

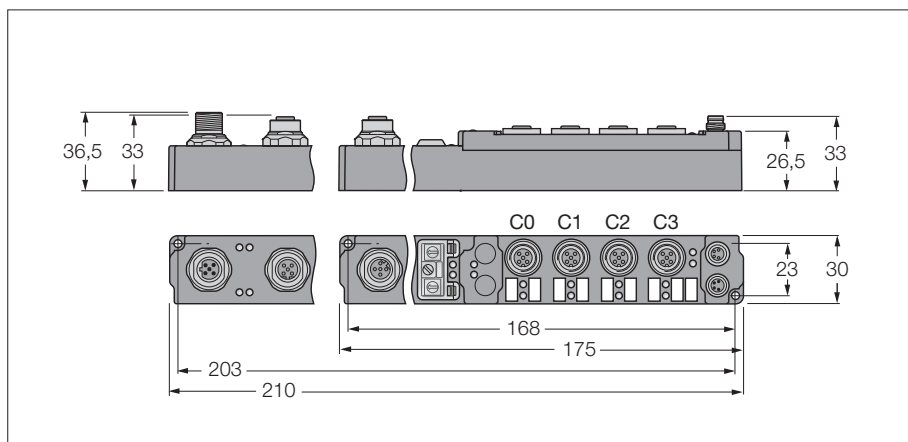

- Up/down counter
- 2-channel
- Switching frequency 100 kHz
- Configuration interface
- Parameterisable functions
- Supported via I/O-ASSISTANT
- Direct connection to the fieldbus
- Fibre-glass reinforced PA6 housing
- Encapsulated module electronics
- Metal connector
- Degree of protection IP67

<b>Operating / load voltage</b>	20...29 VDC
Operating current	≤ 30 mA
<b>Fieldbus transmission rate</b>	9.6 kbps up to 12 Mbps
Fieldbus addressing	0 to 99
Service interface	parameterisation via I/O-ASSISTANT
Electrical isolation	fieldbus to operational voltage
<b>Number of channels</b>	2 count-, 2 gate inputs, 2 V/R changeover contacts
Low level signal voltage	-3 to 5 VDC
High level signal voltage	11 to 30 VDC
Current consumption	≤ 10 mA
Switching frequency	≤ 100000 Hz
<b>Number of channels</b>	2 x 24 VDC/0.5 A, short-circuit proof
Sensor supply	short-circuit proof, max. 0.5 A from operating voltage
<b>Operating temperature</b>	0 to 55 °C

### Data in process image

Pre-conditions	Adresse	Input data		Output data	
	Word	High-Byte	Low-Byte	High-Byte	Low-Byte
<b>Complex mapping:</b> Data are mapped with control and status byte	<b>0</b>	Ch0 D3	SB0	Ch0 D3	CB0
	<b>1</b>	Ch0 D1	Ch0 D2	Ch0 D1	Ch0 D2
	<b>2</b>	SB1	Ch0 D0	CB1	Ch0 D0
	<b>3</b>	Ch1 D2	Ch1 D3	Ch1 D2	Ch1 D3
	<b>4</b>	Ch1 D0	Ch1 D1	Ch1 D0	Ch1 D1

**piconet® stand-alone module for PROFIBUS-DP  
2-channel up/down counter**

**Device types**

Dimensions	Type	Connection
	<b>6824068 SDPB-0202D-0003</b>	F083, F093, F129, F081
	<b>6824413 SDPB-0202D-1003</b>	F084, F093, F129, F081

**Connection**

**F083 - Fieldbus M12 x 1**

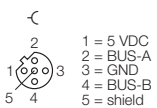

**F093 - Input M12 x 1**

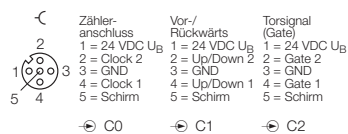

**F081 - Voltage supply M8 x 1**

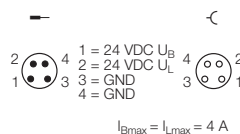

**F084 - Fieldbus M12 x 1**

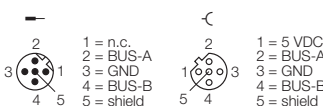

**F129 - Output M12 x 1**

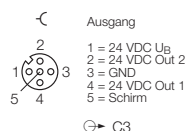

**piconet® stand-alone module for PROFIBUS-DP**  
**Single-channel incremental encoder interface**

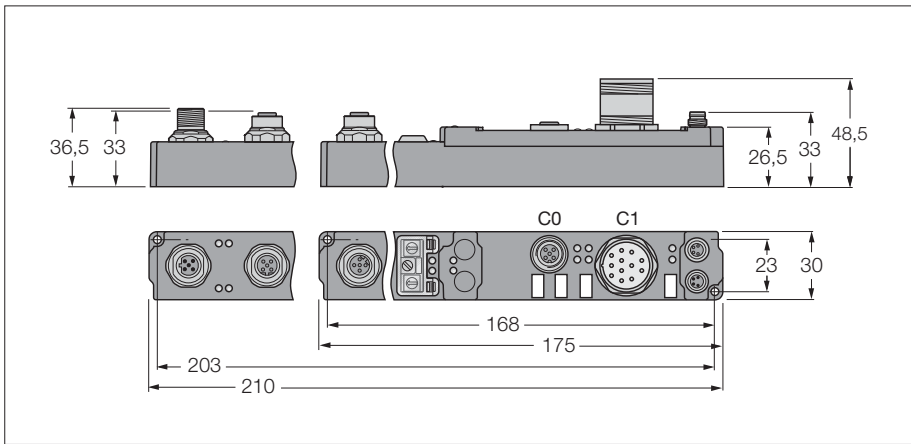

- Incremental encoder interface
- 1-channel
- Configuration interface
- Parameterisable functions
- Supported via I/O-ASSISTANT
- Direct connection to the fieldbus
- Fibre-glass reinforced PA6 housing
- Encapsulated module electronics
- Metal connector
- Degree of protection IP67

<b>Operating / load voltage</b>	20...29 VDC
Operating current	≤ 140 mA
<b>Fieldbus transmission rate</b>	9.6 kbps up to 12 Mbps
Fieldbus addressing	0 to 99
Service interface	parameterisation via I/O-ASSISTANT
Electrical isolation	fieldbus to operational voltage
<b>Maximum limiting frequency, analogue</b>	1 MHz
Rectangular decoder	1-port, 2-port, 4-port evaluation
Counter	16 bit binary
Actuator power supply	5 VDC
Zero pulse latch	16 bit
Commands	read, set, activate
<b>Operating temperature</b>	0 to 55 °C

**Data in process image**

Pre-conditions	Address	Input data		Output data	
	Word	High-Byte	Low-Byte	High-Byte	Low-Byte
<b>Complex mapping:</b> Data are mapped with control and status byte	0	D1	SB	Reg1	CB
	1	D2	D0	reserved	Reg0
	2	D3	D4	reserved	reserved

**piconet® stand-alone module for PROFIBUS-DP**  
**Single-channel incremental encoder interface**

**Device types**

Dimensions	Type	Connection
	<b>6824074 SDPB-10S-0001</b>	F083, F095, F110, F081
	<b>6824445 SDPB-10S-1001</b>	F084, F095, F110, F081

**3**

**Connection**

F083 - Fieldbus M12 x 1

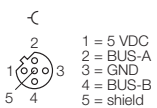

F095 - Gate-/latch input - M12 x 1

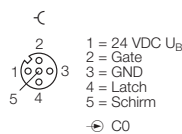

F081 - Voltage supply M8 x 1

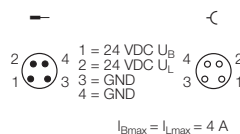

F084 - Fieldbus M12 x 1

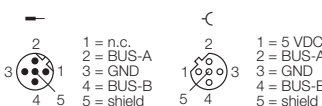

F110 - Encoder - M23 x 1

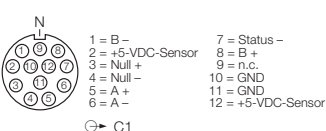

**piconet® stand-alone module for PROFIBUS-DP**  
**Single channel serial interface RS232**

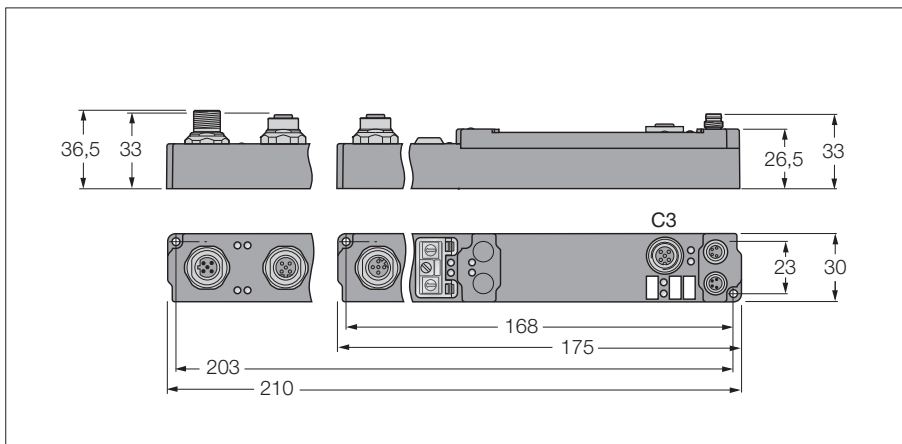

- Serial interface RS232
- 1-channel
- Configuration interface
- Parameterisable functions
- Supported via I/O-ASSISTANT
- Single channel serial interface RS232
- Direct connection to the fieldbus
- Fibre-glass reinforced PA6 housing
- Encapsulated module electronics
- Metal connector
- Degree of protection IP67

<b>Operating / load voltage</b>	20...29 VDC
Operating current	≤ 115 mA
<b>Fieldbus transmission rate</b>	9.6 kbps up to 12 Mbps
Fieldbus addressing	0 to 99
Service interface	parameterisation via I/O-ASSISTANT
Electrical isolation	fieldbus to operational voltage
<b>Bit distortion</b>	≤ 3 %
Transmission rate	1.2 to 19.2 kBit/s (default 9.6 kbps)
RS232 Cable length	≤ 15 m
Low level signal voltage	-18 to -3 VDC
High level signal voltage	3 to 18 VDC
Data buffer	128 byte receive buffer, 16 byte send buffer
<b>Operating temperature</b>	0 to 55 °C

**Data in process image**

Pre-conditions	Address	Input data		Output data	
	Word	High-Byte	Low-Byte	High-Byte	Low-Byte
<b>Complex mapping:</b> Data are mapped with control and status byte	0	D1	SB	Reg1	CB
	1	D2	D0	reserved	Reg0
	2	D3	D4	reserved	reserved



**piconet® stand-alone module for PROFIBUS-DP**  
**Single channel serial interface RS232**

**Device types**

Dimensions	Type	Connection
	<b>6824075 SDPB-10S-0002</b>	F083, F111, F081
	<b>6824446 SDPB-10S-1002</b>	F084, F111, F081

**Connection**

F083 - Fieldbus M12 x 1

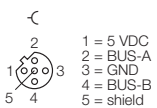

F111 - Input M12 x 1

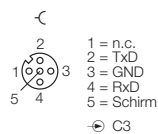

F084 - Fieldbus M12 x 1

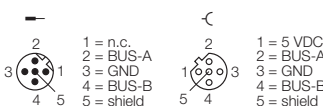

F081 - Voltage supply M8 x 1

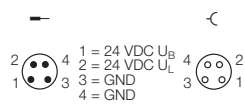

$I_{Bmax} = I_{Lmax} = 4 A$

**piconet® stand-alone module for PROFIBUS-DP**  
**Single channel serial interface 0...20 mA (TTY)**

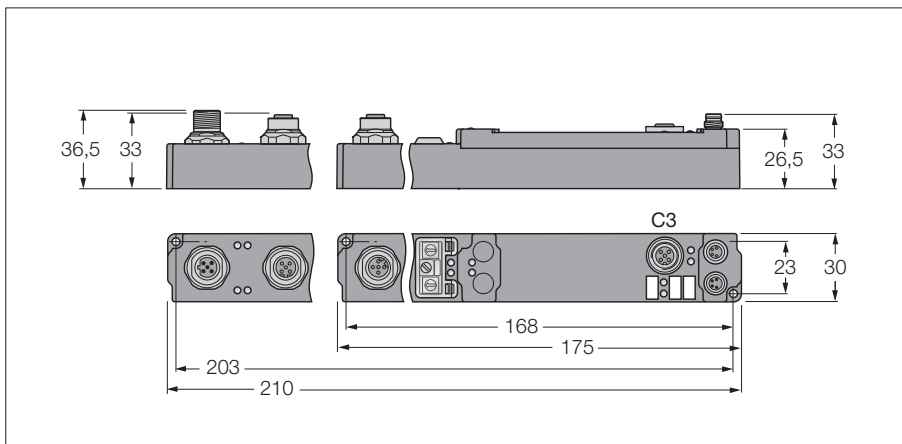

- Serial interface 0...20 mA (TTY)
- 1-channel
- Configuration interface
- Parameterisable functions
- Supported via I/O-ASSISTANT
- Direct connection to the fieldbus
- Fibre-glass reinforced PA6 housing
- Encapsulated module electronics
- Metal connector
- Degree of protection IP67

<b>Operating / load voltage</b>	20...29 VDC
Operating current	≤ 115 mA
<b>Fieldbus transmission rate</b>	9.6 kbps up to 12 Mbps
Fieldbus addressing	0 to 99
Service interface	parameterisation via I/O-ASSISTANT
Electrical isolation	fieldbus to operational voltage
<b>Low level signal current</b>	0 to 3 mA
High level signal current	14 to 20 mA
<b>Load resistance</b>	≤ 500 Ω
<b>Bit transfer</b>	2 x 20 mA
Transmission rate	1.2 to 19.2 kBit/s (default 9.6 kbps)
Transfer circuit	twisted pair ≤ 1000 m
Data buffer	128 byte receive buffer, 16 byte send buffer
Electrical isolation	operational voltage to TTY
<b>Operating temperature</b>	0 to 55 °C

**Data in process image**

Pre-conditions	Address	Input data		Output data	
	Word	High-Byte	Low-Byte	High-Byte	Low-Byte
<b>Complex mapping:</b> Data are mapped with control and status byte	0	D1	SB	Reg1	CB
	1	D2	D0	reserved	Reg0
	2	D3	D4	reserved	reserved

**piconet® stand-alone module for PROFIBUS-DP**  
Single channel serial interface 0...20 mA (TTY)

**Device types**

Dimensions	Type	Connection
	<b>6824076 SDPB-10S-0003</b>	F083, F094, F130, F081
	<b>6824447 SDPB-10S-1003</b>	F084, F094, F130, F081

**3**

**Connection**

F083 - Fieldbus M12 x 1

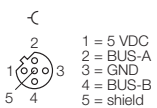

F094 - Input M12 x 1

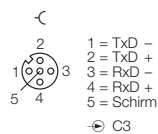

F081 - Voltage supply M8 x 1

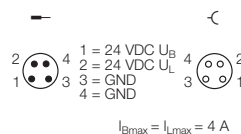

F084 - Fieldbus M12 x 1

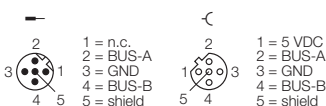

F130 - Connection - passive TTY devices

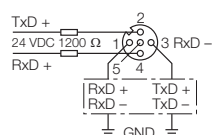

**piconet® stand-alone module for PROFIBUS-DP**  
**Single channel serial interface RS232/RS485**

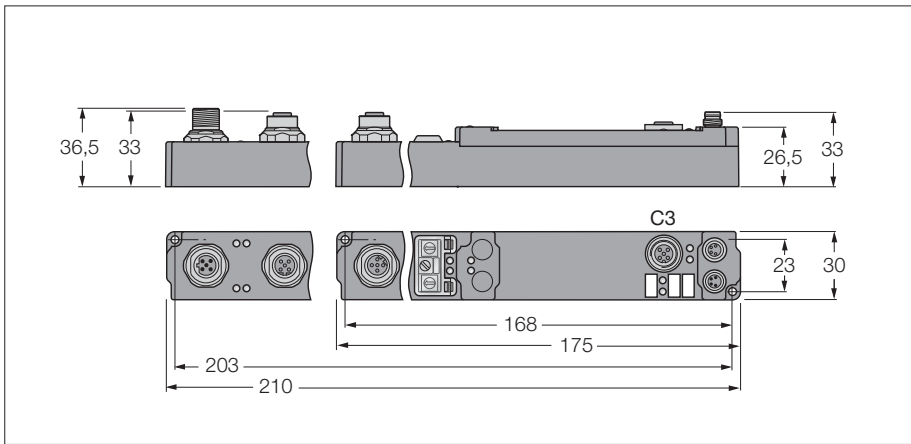

- Serial interface RS422/485
- 1-channel
- Configuration interface
- Parameterisable functions
- Supported via I/O-ASSISTANT
- Direct connection to the fieldbus
- Fibre-glass reinforced PA6 housing
- Encapsulated module electronics
- Metal connector
- Degree of protection IP67

<b>Operating / load voltage</b>	20...29 VDC
Operating current	≤ 115 mA
<b>Fieldbus transmission rate</b>	9.6 kbps up to 12 Mbps
Fieldbus addressing	0 to 99
Service interface	parameterisation via I/O-ASSISTANT
Electrical isolation	fieldbus to operational voltage
<b>Line impedance</b>	120 Ω
<b>Common mode voltage</b>	max. -7...+12 V (against ground)
Bit transfer	differential
Transmission rate	1.2 to 19.2 kBit/s (default 9.6 kbps)
Transfer circuit	twisted pair ≤ 1000 m
Data buffer	128 byte receive buffer, 16 byte send buffer
Electrical isolation	operating voltage to RS485
<b>Operating temperature</b>	0 to 55 °C

**Data in process image**

Pre-conditions	Address		Input data		Output data	
	Word	High-Byte	Low-Byte	High-Byte	Low-Byte	
<b>Complex mapping:</b> Data are mapped with control and status byte	0	D1	SB	Reg1	CB	
	1	D2	D0	reserved	Reg0	
	2	D3	D4	reserved	reserved	

**piconet® stand-alone module for PROFIBUS-DP**  
**Single channel serial interface RS232/RS485**

**Device types**

Dimensions	Type	Connection
	<b>6824077 SDPB-10S-0004</b>	F083, F094, F130, F081
	<b>6824448 SDPB-10S-1004</b>	F084, F094, F130, F081

**Connection**

F083 - Fieldbus M12 x 1

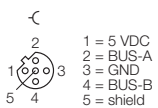

F094 - Input M12 x 1

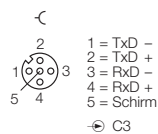

F081 - Voltage supply M8 x 1

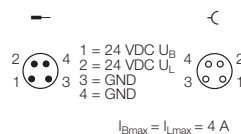

F084 - Fieldbus M12 x 1

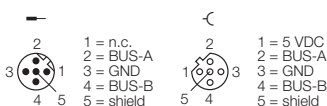

F130 - Connection - RS485 devices

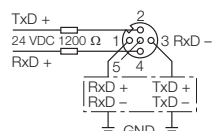

## **piconet® stand-alone module for PROFIBUS-DP**

### **Single channel SSI sensor interface**

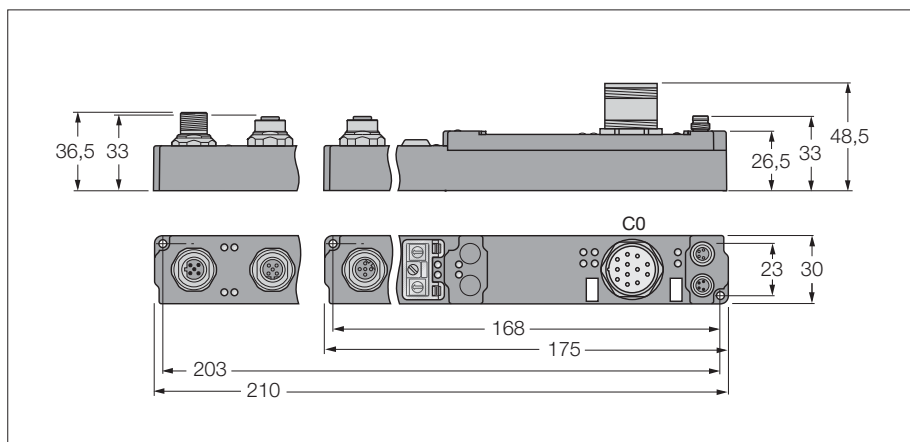

- SSI encoder interface
- 1-channel
- Configuration interface
- Parameterisable functions
- Supported via I/O-ASSISTANT
- Direct connection to the fieldbus
- Fibre-glass reinforced PA6 housing
- Encapsulated module electronics
- Metal connector
- Degree of protection IP67

<b>Operating / load voltage</b>	20...29 VDC
Operating current	≤ 140 mA
<b>Fieldbus transmission rate</b>	9.6 kbps up to 12 Mbps
Fieldbus addressing	0 to 99
Service interface	parameterisation via I/O-ASSISTANT
Electrical isolation	fieldbus to operational voltage
<b>Bit transfer</b>	differential (RS485)
Transmission rate	variable up to 1 MHz (default 250 Hz)
Serial input	24 bit
Data direction	read
Sensor supply	24 VDC from load voltage
Electrical isolation	operating voltage to RS232
<b>Operating temperature</b>	0 to 55 °C

#### **Data in process image**

Pre-conditions	Address	Input data		Output data	
		Word	High-Byte	Low-Byte	High-Byte
<b>Compact mapping:</b> Starting with D3 in "Low-Byte" word 0 all other bytes follow immediately (highlighted in grey). <b>Complex mapping:</b> Data are mapped with control and status byte	<b>0</b>	D3	SB	Reg1	CB
	<b>1</b>	D1	D2	reserved	Reg0
	<b>2</b>	reserved	D0	reserved	reserved

**piconet® stand-alone module for PROFIBUS-DP**  
**Single channel SSI sensor interface**

**Device types**

Dimensions	Type	Connection
	<b>6824078 SDPB-10S-0005</b>	F083, F096, F081
	<b>6824444 SDPB-10S-1005</b>	F084, F096, F081

**Connection**

F083 - Fieldbus M12 x 1

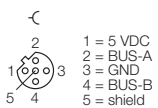

F096 - Encoder - M23 x 1

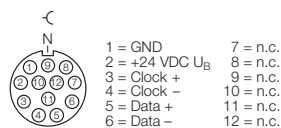

F084 - Fieldbus M12 x 1

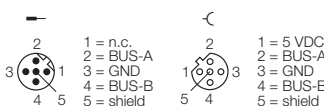

F081 - Voltage supply M8 x 1

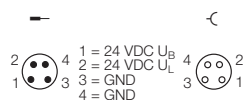

$I_{Bmax} = I_{Lmax} = 4 A$

**PROFI**  
PROCESS FIELD BUS  
**BUS**

**DeviceNet™**

**Modbus TCP**

**EtherNet/IP™**

**PROFI**<sup>®</sup>  
INDUSTRIAL ETHERNET  
**NET**

**DIGITAL**



# Compact fieldbus I/O modules in IP67 and IP20

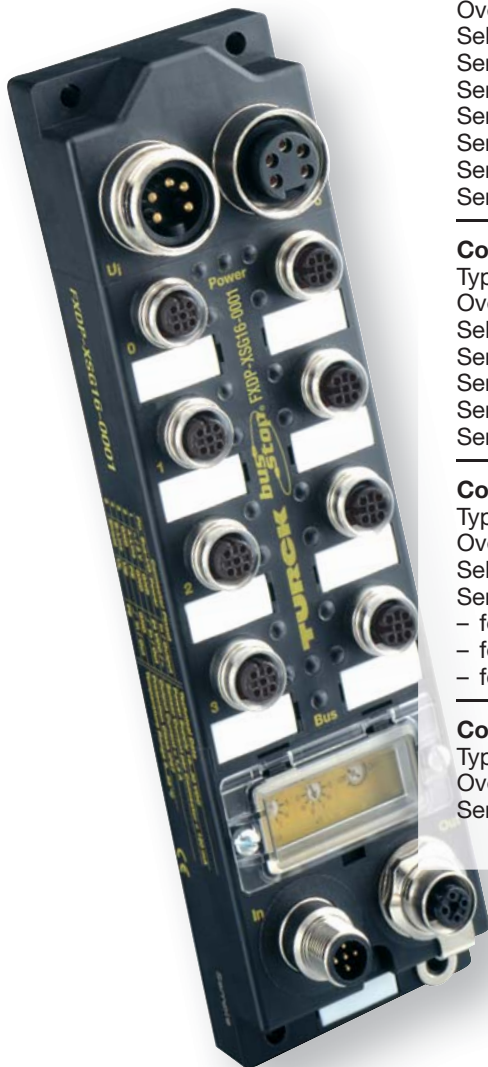

	<b>Page</b>
<b>Compact fieldbus I/O modules in IP67 and IP20</b>	
System concept	250
<b>Compact fieldbus I/O modules for PROFIBUS-DP in IP67</b>	
Type code	252
Overview FXDP/FGDP/FLDP series	253
Selection guide	254
Series FXDP – general information	255
Series FXDP	256
Series FGDP – general information	263
Series FGDP	264
Series FLDP – general information	266
Series FLDP	267
<b>Compact fieldbus I/O modules for DeviceNet™ in IP67</b>	
Type code	280
Overview FDNL/FDNP series	281
Selection guide	282
Series FDNL – general information	283
Series FDNL	284
Series FDNP – general information	291
Series FDNP	292
<b>Compact fieldbus I/O modules for Ethernet in IP67</b>	
Type code	304
Overview FXEN series	305
Selection guide	306
Series FXEN – general information	307
– for Modbus TCP	308
– for EtherNet/IP	310
– for PROFINET	313
<b>Compact fieldbus I/O modules in IP20</b>	
Type code	316
Overview FDN/FDP series	317
Series FDN/FDP	318

# Compact fieldbus I/O modules in IP67 and IP20

## Compact fieldbus modules

These rugged modules are ideal for use in harsh industrial environments (both electrical and mechanical). No matter if PROFIBUS-DP, DeviceNet™, Modbus TCP, EtherNet/IP or PROFINET protocols are required, all compact fieldbus I/O modules are designed with the same mechanical concept and have the following characteristics:

- Fibre-glass reinforced plastic housing
- Fully encapsulated module electronics
- Standard connection technology
- Metal round connector
- Vibration and shock tested
- Degree of protection IP67



### FXDP – Configurable PROFIBUS-DP modules

- Freely configurable I/Os
- Channel-specific diagnostics
- Diagnostics according to PROFIBUS standard
- Diagnostics can be mapped to user data area
- Up to 16 digital channels



### FGDP – PROFIBUS-DP-Modules with galvanic isolation

- Channel-specific diagnostics
- Diagnostics according to PROFIBUS standard
- Diagnostics can be mapped to user data area
- Up to 16 digital channels
- Galvanic isolation of operating and load voltage



### FLDP – PROFIBUS-DP modules

- Module-specific diagnostics
- Up to 32 digital channels





**FDNL – DeviceNet™ modules**

- Channel-specific diagnostics (LX series) or module-specific diagnostics (SE series)
- Up to 16 digital channels
- Power supply via DeviceNet™



**FDNP – DeviceNet™ module**

- Channel-specific diagnostics (LX series) or module-specific diagnostics (SE series)
- Up to 16 digital channels
- Separate power supply for the outputs



**FDN/FDP – IP20 modules**

- Extremely compact for mounting in tight spaces
- PROFIBUS-DP or DeviceNet™
- Up to 16 digital channels



**FXEN – Configurable Ethernet modules**

- Integrated Ethernet switch
- Freely configurable I/Os
- Channel-specific diagnostics
- Up to 16 digital channels

**Accessories**

- Cordsets – premoulded cables for bus, power supply and I/Os
- T and Y pieces Terminating resistors
- Flange connectors
- Feed-through receptacles
- Passive junction boxes

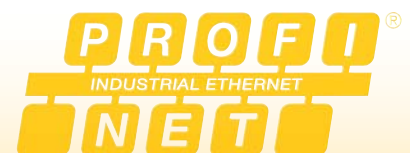

# Compact fieldbus I/O modules in IP67 for PROFIBUS-DP

## Type code

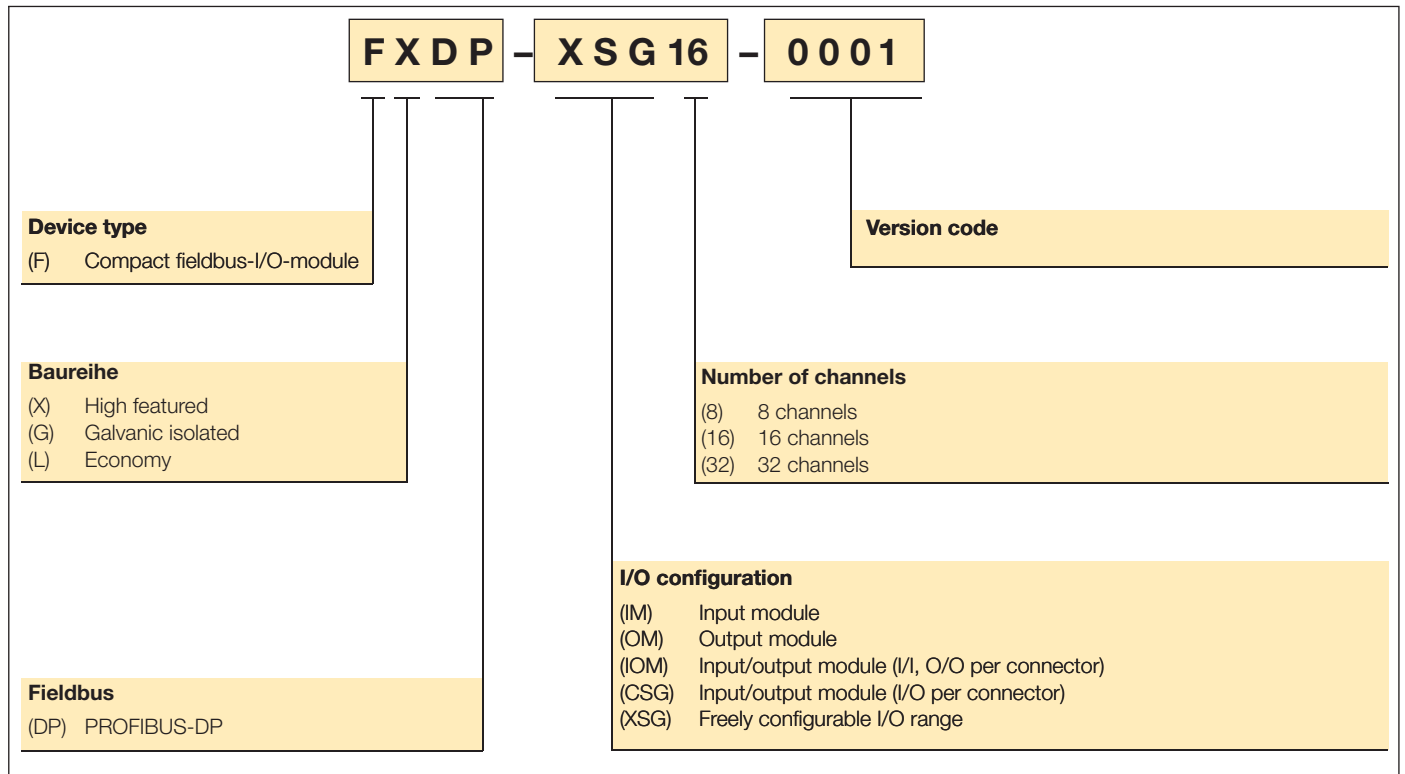

# Compact fieldbus I/O modules in IP67 for PROFIBUS-DP

**TURCK**

Industrial  
Automation

## Series FLDP



### Housing version 1

- Compact flat housing
- Up to 16 channels
- Two bus connectors
- Module-specific diagnostics

### Housing version 2

- Compact flat housing
- Up to 32 channels
- Two bus connectors
- Module-specific diagnostics

## Series FXDP



- Compact flat housing
- Up to 16 channels
- Channel-specific diagnostics
- Diagnostics can be mapped to user data area
- Freely configurable I/Os

## Series FGDP



- Compact flat housing
- Up to 16 channels
- Channel-specific diagnostics
- Diagnostics can be mapped to user data area
- Galvanic isolation of operating and load voltage

# Compact fieldbus I/O modules in IP67 for PROFIBUS-DP

## Selection guide

		Housing type	Number of inputs	Number of outputs	Number of inputs/outputs per connector	Maximum load current [A]	Integrated bus-T-piece	Page
<b>FXDP modules – channel-specific diagnostics, freely configurable I/O range</b>	<b>Ident-no.</b>							
FXDP-IM8-0001	6825400	–	8	–	1/–	–	•	256
FXDP-IM16-0001	6825401	–	16	–	2/–	–	•	257
FXDP-OM8-0001	6825402	–	–	8	–/1	1.4	•	258
FXDP-OM16-0001	6825403	–	–	16	–/2	1.4	•	259
FXDP-IOM88-0001	6825404	–	8	8	2/2	1.4	•	260
FXDP-CSG88-0001	6825405	–	8	8	1/1	1.4	•	261
FXDP-XSG16-0001	6825406	–	16 configurable channels			1.4	•	262
<b>FGDP modules – channel-specific diagnostics, galvanic isolation of operating and load voltage</b>								
FGDP-IM16-0001	6825368	–	16	–	2/–	–	•	264
FGDP-IOM84-0001	6825369	–	8	8	2/2	1.4	•	265
<b>FLDP modules – module-specific diagnostics</b>								
FLDP-IM8-0001	6825320	1	8	–	1/–	–	•	267
FLDP-IM16-0001	6825326	1	16	–	2/–	–	•	268
FLDP-IM32-0001	6825332	3	32	–	2/–	–	•	269
FLDP-OM8-0001	6825321	1	–	8	–/1	0.5	•	270
FLDP-OM8-0002	6825331	1	–	8	–/1	2	•	271
FLDP-OM16-0001	6825327	1	–	16	–/2	0.5	•	272
FLDP-IOM84-0001	6825330	1	8	4	2/1	2	•	273
FLDP-IOM88-0001	6825322	1	8	8	1/1	0.5	•	274
FLDP-IOM88-0002	6825323	1	8	8	2/2	0.5	•	275
FLDP-IOM1616-0001	6825338	3	16	16	2/2	0.5	•	276
FLDP-IOM2012-0001	6825339	3	20	12	Burndy	0.5	•	277
FLDP-IOM248-0001	6825333	3	24	8	2/2	0.5	•	279

# Compact fieldbus I/O modules in IP67 for PROFIBUS-DP

**TURCK**

Industrial  
Automation

## Series FXDP – general information



The compact FXDP series fieldbus I/O modules allow direct connection of up to 16 inputs/outputs to a PROFIBUS-DP network.

The I/O modules offer channel-specific short-circuit diagnostics of the outputs and module specific short-circuit diagnostics of the inputs. The diagnostics can also be mapped to the user data area.

The XSG version also allows the I/O area to be freely configured.

Operating and load voltage are fed separately. If the load supply is switched off, the module electronics and all inputs continue operation when the outputs are turned off. In this case, the load voltage diagnostics can also be deactivated.

The I/O modules support transmission rates of 12 Mbps. The PROFIBUS-DP connection is implemented via 5-pole, reverse-keyed M12 x 1 connectors. The module is powered via a 7/8" round connector and can be fed through via a second 7/8" round connector.

The I/O level is equipped throughout with metal M12 connectors.

Glass-fibre reinforced plastic housings and the fully encapsulated module electronics guarantee protection degree IP67. The I/O modules are therefore particularly suited for use in harsh industrial environments.

### General technical data

#### Characteristics

Extended diagnostics, connector-specific short-circuit diagnostics of the sensor supply voltage, channel-specific short-circuit diagnostics of the outputs, Complete diagnostic information according to standards via the PROFIBUS-DP, channel-specific display of status and errors via LEDs, diagnostics can be mapped to the user data area (diagnostics inputs).

#### Settings

PROFIBUS-DP

address 1...126 (decimal) adjustable via three coded rotary switches  
Transmission rate of 9.6 kbps up to 12 Mbps, automatic

#### LEDs

Bus (dual colour LED)  
Power (dual colour LED)  
Inputs (dual colour LED)  
Outputs (dual colour LED)

green: communication, red: no communication  
green: operational, off: UB < 18 VDC, red: UL < 18V (only modules with digital outputs)  
green: ON, red: short-circuit  
green: ON, red: short-circuit

#### Connections

PROFIBUS  
Power supply  
Inputs/outputs

Nickel-plated brass  
1 x male M12 connector (IN), 1 x female M12 connector (OUT), 5-pole, reverse-keyed  
1 x 7/8" male connector (IN), 1 x 7/8" female connector (OUT), 5-pole  
8 female M12 x 1 connectors; 5-pole

#### Housing

Mounting  
Degree of protection  
Vibration and shock tested  
EMC  
Temperature range  
– Operating temperature  
– Storage and transport temperature  
Dimensions

PA6-GF30, glass-fibre reinforced plastic housing with encapsulated electronics and nickel-plated brass connectors  
via 4 through-holes, Ø 5.4 mm  
(IEC 60529/EN 60529) IP67  
according to EN 60068-2-6, 2-27  
to EN 61000-6-2, IEC 61000-6-4  
-25 °C to +55 °C (-25 °F to +131 °F)  
-25 °C to +70 °C (-13 °F to +158 °F)  
220.5 x 62.4 x 27 mm (H x W x D)

#### Approvals

CE, ,  II 3G EEx nA IIC T4X (EC Ex-regulations 94/9/EG)

# Fieldbus I/O module PROFIBUS-DP

## 8 digital pnp inputs

### FXDP-IM8-0001

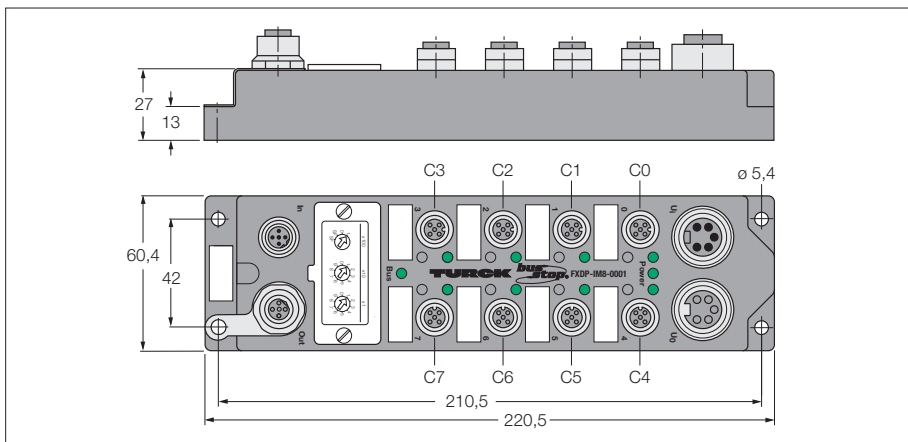

- ATEX category II 3 G, Ex Zone 2
- 8 digital pnp inputs
- Diagnostics can be mapped in user data
- Input diagnostics per slot
- One channel per connector
- Fibre-glass reinforced PA6 housing
- Vibration and shock-resistant
- Encapsulated module electronics
- Metal connector
- Degree of protection IP67

<b>Type</b>	FXDP-IM8-0001
Ident-No.	6825400
<b>Operating / load voltage</b>	18...30 VDC
Operating current	< 75 mA
<b>Fieldbus transmission rate</b>	9.6 kbps up to 12 Mbps
Fieldbus addressing	1...126 (decimal) via three coded rotary switches
Electrical isolation	to operating and load voltage
<b>Inputs</b>	
Number of channels	(8) 3-wire pnp sensors
Input voltage	18...30 VDC via operating voltage
Supply current	< 120 mA per channel, short-circuit proof
Switching threshold	2 mA / 4 mA
Input delay	2.5 ms
Switching frequency	≤ 250 Hz
Max. input current	6 mA
Electrical isolation	galvanic isolation against the bus
<b>Operating temperature</b>	- 25...55 °C

#### Fieldbus M12 x 1

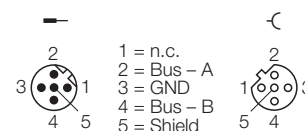

#### Input M12 x 1

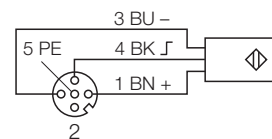

#### Power supply 7/8"

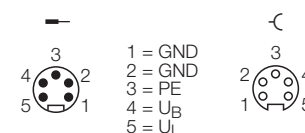

#### Data in process image

C1P4: Male Connector 1, 4-pole

SC: Short-circuit - group signal

SC3: Short-circuit channel 3

Con2: Overload sensor supply C2

UB: UB < 18 VDC

		Bit 7	Bit 6	Bit 5	Bit 4	Bit 3	Bit 2	Bit 1	Bit 0
<b>Input</b>	<b>Byte 0</b>	C7P4	C6P4	C5P4	C4P4	C3P4	C2P4	C1P4	C0P4
<b>Diagnostics</b>	<b>Byte 0</b>	-	-	-	-	-	UB	UL	SC
	<b>Byte 1</b>	SC 7	SC 6	SC 5	SC 4	SC 3	SC 2	SC 1	SC 0
	<b>Byte 2</b>	SC 15	SC 14	SC 13	SC 12	SC 11	SC 10	SC 9	SC 8
	<b>Byte 3</b>	Con 7	Con 6	Con 5	Con 4	Con 3	Con 2	Con 1	Con 0



**Fieldbus I/O module PROFIBUS-DP  
16 digital pnp inputs  
FXDP-IM16-0001**

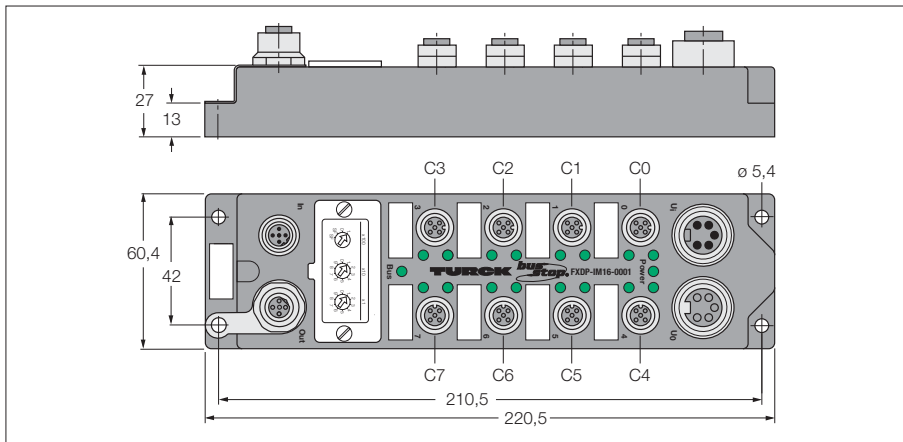

- ATEX category II 3 G, Ex Zone 2
- 16 digital pnp inputs
- Diagnostics can be mapped in user data
- Input diagnostics per slot
- Two channels per connector
- Fibre-glass reinforced PA6 housing
- Vibration and shock-resistant
- Encapsulated module electronics
- Metal connector
- Degree of protection IP67

<b>Type</b>	FXDP-IM16-0001
Ident-No.	6825401
<b>Operating / load voltage</b>	18...30 VDC
Operating current	< 75 mA
<b>Fieldbus transmission rate</b>	9.6 kbps up to 12 Mbps
Fieldbus addressing	1...126 (decimal) via three coded rotary switches
Electrical isolation	to operating and load voltage
<b>Inputs</b>	
Number of channels	(16) 3-wire pnp sensors
Input voltage	18...30 VDC via operating voltage
Supply current	< 120 mA per channel, short-circuit proof
Switching threshold	2 mA / 4 mA
Input delay	2.5 ms
Switching frequency	≤ 250 Hz
Max. input current	6 mA
Electrical isolation	galvanic isolation against the bus
<b>Operating temperature</b>	- 25...55 °C

**Fieldbus M12 x 1**

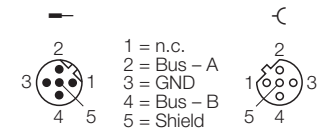

**Input M12 x 1**

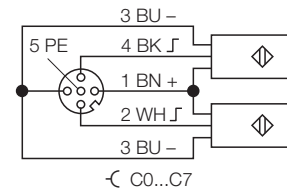

**Power supply 7/8"**

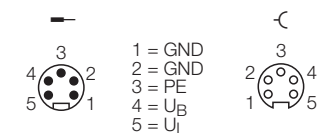

**Data in process image**

C1P4: Male Connector 1, 4-pole  
 SC: Short-circuit - group signal  
 SC3: Short-circuit channel 3  
 Con2: Overload sensor supply C2  
 UB: UB < 18 VDC

		Bit 7	Bit 6	Bit 5	Bit 4	Bit 3	Bit 2	Bit 1	Bit 0
<b>Input</b>	<b>Byte 0</b>	C3P2	C3P4	C2P2	C2P4	C1P2	C1P4	C0P2	C0P4
	<b>Byte 1</b>	C7P2	C7P4	C6P2	C6P4	C5P2	C5P4	C4P2	C4P4
<b>Diagnostics<sup>1)</sup></b>	<b>Byte 0</b>	-	-	-	-	-	UB	UL	SC
	<b>Byte 1</b>	SC 7	SC 6	SC 5	SC 4	SC 3	SC 2	SC 1	SC 0
	<b>Byte 2</b>	SC 15	SC 14	SC 13	SC 12	SC 11	SC 10	SC 9	SC 8
	<b>Byte 3</b>	Con 7	Con 6	Con 5	Con 4	Con 3	Con 2	Con 1	Con 0

<sup>1)</sup> The manufacturer-specific diagnostics can be fully mapped to the user data area via the configuration menu.

# Fieldbus I/O module PROFIBUS-DP

## 8 digital outputs 1.4 A

### FXDP-OM8-0001

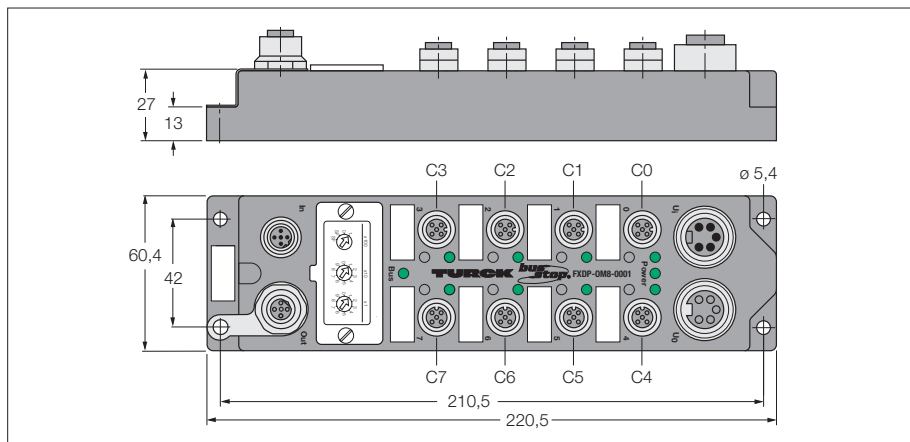

- ATEX category II 3 G, Ex Zone 2
- 8 digital outputs 1.4 A
- Diagnostics can be mapped in user data
- Output diagnostics per channel
- One channel per connector
- Fibre-glass reinforced PA6 housing
- Vibration and shock-resistant
- Encapsulated module electronics
- Metal connector
- Degree of protection IP67

<b>Type</b>	FXDP-OM8-0001
Ident-No.	6825402
<b>Operating / load voltage</b>	18...30 VDC
Operating current	< 75 mA
<b>Fieldbus transmission rate</b>	9.6 kbps up to 12 Mbps
Fieldbus addressing	1...126 (decimal) via three coded rotary switches
Electrical isolation	to operating and load voltage
<b>Outputs</b>	
Number of channels	(8) DC actuators
Output voltage	18...30 VDC from load voltage
Output current per channel	1.4 A, short-circuit proof
Load type	resistive, inductive, lamp load
Switching frequency	≤ 250 Hz
Simultaneity factor	0.8
Electrical isolation	galvanic isolation against the bus
<b>Operating temperature</b>	- 25...55 °C

#### Fieldbus M12 x 1

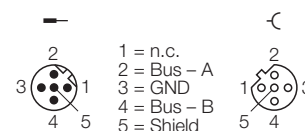

#### Output M12 x 1

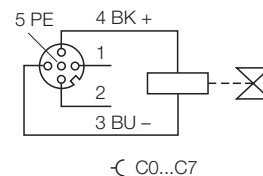

#### Power supply 7/8"

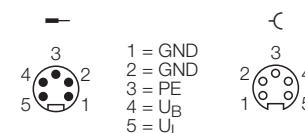

#### Data in process image

C1P4: Male Connector 1, 4-pole  
 SC: Short-circuit - group signal  
 SC3: Short-circuit channel 3  
 Con2: Overload sensor supply C2  
 UB: UB < 18 VDC  
 UL: UL < 18 VDC

		Bit 7	Bit 6	Bit 5	Bit 4	Bit 3	Bit 2	Bit 1	Bit 0
<b>Output</b>	<b>Byte 0</b>	C7P4	C6P4	C5P4	C4P4	C3P4	C2P4	C1P4	C0P4
<b>Diagnostics</b>	<b>Byte 0</b>	-	-	-	-	-	UB	UL	SC
	<b>Byte 1</b>	SC 7	SC 6	SC 5	SC 4	SC 3	SC 2	SC 1	SC 0
	<b>Byte 2</b>	SC 15	SC 14	SC 13	SC 12	SC 11	SC 10	SC 9	SC 8
	<b>Byte 3</b>	Con 7	Con 6	Con 5	Con 4	Con 3	Con 2	Con 1	Con 0

**Fieldbus I/O module PROFIBUS-DP  
16 digital outputs 1.4 A  
FXDP-OM16-0001**

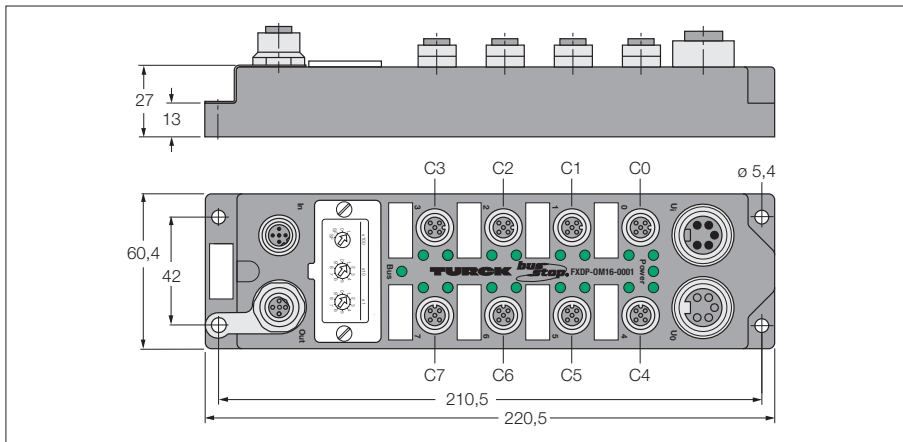

- ATEX category II 3 G, Ex Zone 2
- 16 digital outputs 1.4 A
- Diagnostics can be mapped in user data
- Output diagnostics per channel
- Two channels per connector
- Fibre-glass reinforced PA6 housing
- Vibration and shock-resistant
- Encapsulated module electronics
- Metal connector
- Degree of protection IP67

<b>Type</b>	FXDP-OM16-0001
Ident-No.	6825403
<b>Operating / load voltage</b>	18...30 VDC
Operating current	< 75 mA
<b>Fieldbus transmission rate</b>	9.6 kbps up to 12 Mbps
Fieldbus addressing	1...126 (decimal) via three coded rotary switches
Electrical isolation	to operating and load voltage
<b>Outputs</b>	
Number of channels	(16) DC actuators
Output voltage	18...30 VDC from load voltage
Output current per channel	1.4 A, short-circuit proof
Load type	resistive, inductive, lamp load
Switching frequency	≤ 250 Hz
Simultaneity factor	0.4
Electrical isolation	galvanic isolation against the bus
<b>Operating temperature</b>	- 25...55 °C

**Fieldbus M12 x 1**

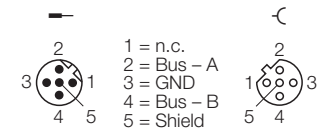

**Output M12 x 1**

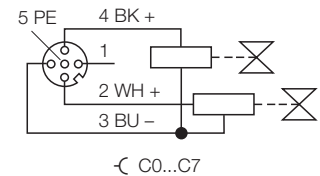

**Power supply 7/8"**

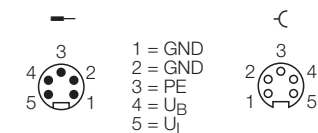

**Data in process image**

- C1P4: Male Connector 1, 4-pole
- SC: Short-circuit - group signal
- SC3: Short-circuit channel 3
- Con2: Overload sensor supply C2
- UB: UB < 18 VDC
- UL: UL < 18 VDC

		Bit 7	Bit 6	Bit 5	Bit 4	Bit 3	Bit 2	Bit 1	Bit 0
<b>Output</b>	<b>Byte 0</b>	C3P2	C3P4	C2P2	C2P4	C1P2	C1P4	C0P2	C0P4
	<b>Byte 1</b>	C7P2	C7P4	C6P2	C6P4	C5P2	C5P4	C4P2	C4P4
<b>Diagnostics</b>	<b>Byte 0</b>	-	-	-	-	-	UB	UL	SC
	<b>Byte 1</b>	SC 7	SC 6	SC 5	SC 4	SC 3	SC 2	SC 1	SC 0
	<b>Byte 2</b>	SC 15	SC 14	SC 13	SC 12	SC 11	SC 10	SC 9	SC 8
	<b>Byte 3</b>	Con 7	Con 6	Con 5	Con 4	Con 3	Con 2	Con 1	Con 0

# Fieldbus I/O module PROFIBUS-DP

**8 digital pnp inputs**  
**8 digital outputs 1.4 A**  
**FXDP-IOM88-0001**

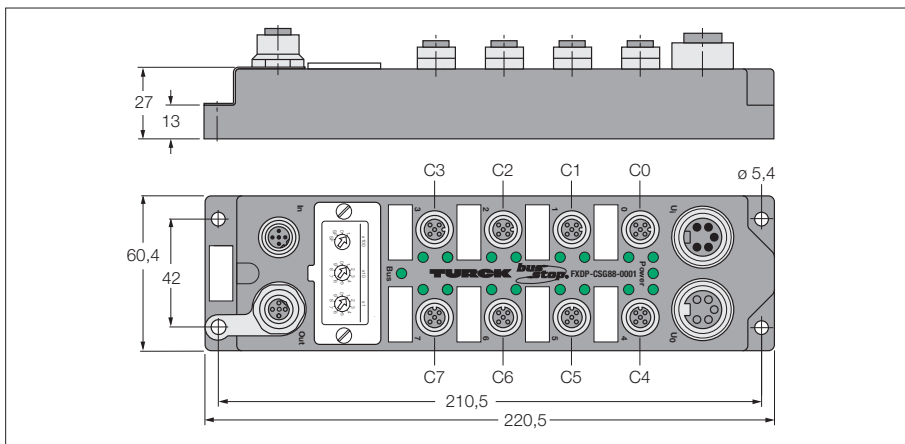

- ATEX category II 3 G, Ex Zone 2
- 8 digital pnp inputs
- and 8 digital outputs, 24 VDC 1.4 A
- Diagnostics can be mapped in user data
- Input diagnostics per slot
- Two channels per connector
- Fibre-glass reinforced PA6 housing
- Vibration and shock-resistant
- Encapsulated module electronics
- Metal connector
- Degree of protection IP67

<b>Type</b>	FXDP-IOM88-0001
Ident-No.	6825404
<b>Operating / load voltage</b>	18...30 VDC
Operating current	< 75 mA
<b>Fieldbus transmission rate</b>	9.6 kbps up to 12 Mbps
Fieldbus addressing	1...126 (decimal) via three coded rotary switches
Electrical isolation	to operating and load voltage
<b>Inputs</b>	
Number of channels	(8) 3-wire pnp sensors
Input voltage	18...30 VDC via operating voltage
Supply current	< 120 mA per channel, short-circuit proof
Switching threshold	2 mA / 4 mA
Input delay	2.5 ms
Switching frequency	≤ 250 Hz
Max. input current	6 mA
Electrical isolation	galvanic isolation against the bus
<b>Outputs</b>	
Number of channels	(8) DC actuators
Output voltage	18...30 VDC from load voltage
Output current per channel	1.4 A, short-circuit proof
Load type	resistive, inductive, lamp load
Switching frequency	≤ 250 Hz
Simultaneity factor	0.8
Electrical isolation	galvanic isolation against the bus
<b>Operating temperature</b>	- 25...55 °C

### Fieldbus M12 x 1

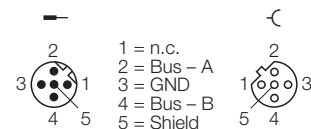

### Input M12 x 1

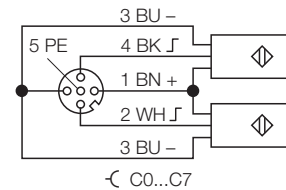

### Output M12 x 1

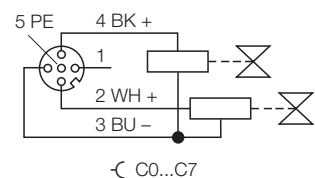

### Power supply 7/8"

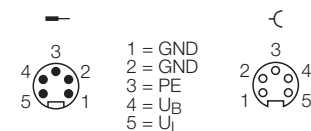

### Data in process image

C1P4: Male Connector 1, 4-pole  
 SC: Short-circuit - group signal  
 SC3: Short-circuit channel 3  
 Con2: Overload sensor supply C2  
 UB: UB < 18 VDC  
 UL: UL < 18 VDC

		Bit 7	Bit 6	Bit 5	Bit 4	Bit 3	Bit 2	Bit 1	Bit 0
<b>Input</b>	<b>Byte 0</b>	C3P2	C3P4	C2P2	C2P4	C1P2	C1P4	C0P2	C0P4
<b>Output</b>	<b>Byte 0</b>	C7P2	C7P4	C6P2	C6P4	C5P2	C5P4	C4P2	C4P4
<b>Diagnostics</b>	<b>Byte 0</b>	-	-	-	-	-	UB	UL	SC
	<b>Byte 1</b>	SC 7	SC 6	SC 5	SC 4	SC 3	SC 2	SC 1	SC 0
	<b>Byte 2</b>	SC 15	SC 14	SC 13	SC 12	SC 11	SC 10	SC 9	SC 8
	<b>Byte 3</b>	Con 7	Con 6	Con 5	Con 4	Con 3	Con 2	Con 1	Con 0

**Fieldbus I/O module PROFIBUS-DP**  
**8 digital pnp inputs**  
**8 digital outputs 1.4 A**  
**FXDP-CSG88-0001**

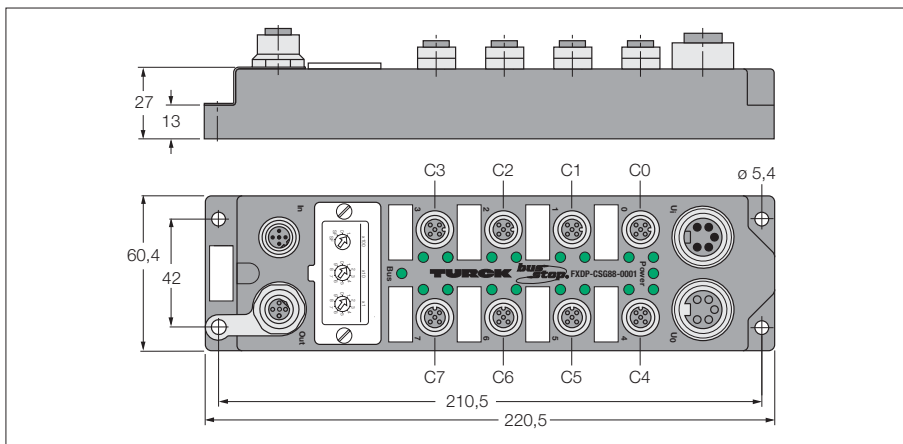

- ATEX category II 3 G, Ex Zone 2
- 8 digital pnp inputs
- and 8 digital outputs, 24 VDC 1.4 A
- Diagnostics can be mapped in user data
- Input diagnostics per slot
- Two channels per connector
- Fibre-glass reinforced PA6 housing
- Vibration and shock-resistant
- Encapsulated module electronics
- Metal connector
- Degree of protection IP67

<b>Type</b>	FXDP-CSG88-0001
<b>Ident-No.</b>	6825405
<b>Operating / load voltage</b>	18...30 VDC
<b>Operating current</b>	< 75 mA
<b>Fieldbus transmission rate</b>	9.6 kbps up to 12 Mbps
<b>Fieldbus addressing</b>	1...126 (decimal) via three coded rotary switches
<b>Electrical isolation</b>	to operating and load voltage
<b>Inputs</b>	
Number of channels	(8) 3-wire pnp sensors
Input voltage	18...30 VDC via operating voltage
Supply current	< 120 mA per channel, short-circuit proof
Switching threshold	2 mA / 4 mA
Input delay	2.5 ms
Switching frequency	≤ 250 Hz
Max. input current	6 mA
Electrical isolation	galvanic isolation against the bus
<b>Outputs</b>	
Number of channels	(8) DC actuators
Output voltage	18...30 VDC from load voltage
Output current per channel	1.4 A, short-circuit proof
Load type	resistive, inductive, lamp load
Switching frequency	≤ 250 Hz
Simultaneity factor	0.8
Electrical isolation	galvanic isolation against the bus
<b>Operating temperature</b>	- 25...55 °C

**Fieldbus M12 x 1**

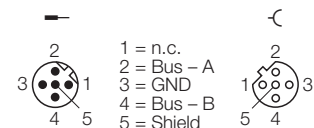

**Input M12 x 1**

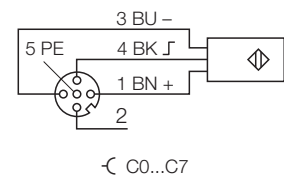

**Output M12 x 1**

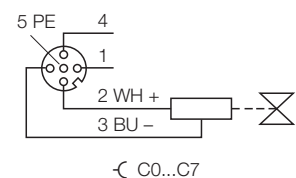

**Power supply 7/8"**

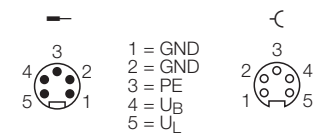

**Data in process image**

C1P4: Male Connector 1, 4-pole  
 SC: Short-circuit - group signal  
 SC3: Short-circuit channel 3  
 Con2: Overload sensor supply C2  
 UB: UB < 18 VDC  
 UL: UL < 18 VDC

		Bit 7	Bit 6	Bit 5	Bit 4	Bit 3	Bit 2	Bit 1	Bit 0
<b>Input</b>	<b>Byte 0</b>	C7P4	C6P4	C5P4	C4P4	C3P4	C2P4	C1P4	C0P4
<b>Output</b>	<b>Byte 0</b>	C7P2	C6P2	C5P2	C4P2	C3P2	C2P2	C1P2	C0P2
<b>Diagnostics</b>	<b>Byte 0</b>	-	-	-	-	-	UB	UL	SC
	<b>Byte 1</b>	SC 7	SC 6	SC 5	SC 4	SC 3	SC 2	SC 1	SC 0
	<b>Byte 2</b>	SC 15	SC 14	SC 13	SC 12	SC 11	SC 10	SC 9	SC 8
	<b>Byte 3</b>	Con 7	Con 6	Con 5	Con 4	Con 3	Con 2	Con 1	Con 0



**Fieldbus I/O module PROFIBUS-DP**  
**16 configurable digital channels**  
**Pnp inputs / outputs 1.4 A**  
**FXDP-XSG16-0001**

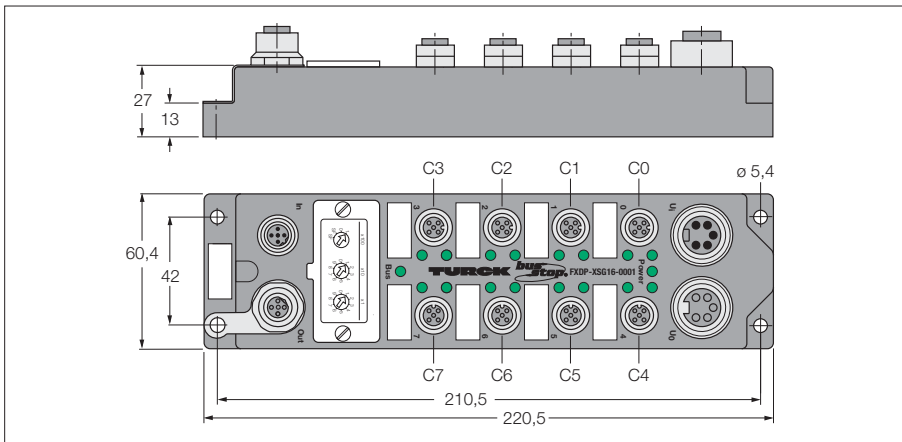

- ATEX category II 3 G, Ex Zone 2
- 16 configurable digital channels
- Diagnostics can be mapped in user data
- Input diagnostics per slot
- Two channels per connector
- Fibre-glass reinforced PA6 housing
- Vibration and shock-resistant
- Encapsulated module electronics
- Metal connector
- Degree of protection IP67

<b>Type</b>	FXDP-XSG16-0001
Ident-No.	6825406
<b>Operating / load voltage</b>	18...30 VDC
Operating current	< 75 mA
<b>Fieldbus transmission rate</b>	9.6 kbps up to 12 Mbps
Fieldbus addressing	1...126 (decimal) via three coded rotary switches
Electrical isolation	to operating and load voltage
<b>Inputs</b>	
Number of channels	(16) 3-wire pnp sensors
Input voltage	18...30 VDC via operating voltage
Supply current	< 120 mA per channel, short-circuit proof
Switching threshold	2 mA / 4 mA
Input delay	2.5 ms
Switching frequency	≤ 250 Hz
Max. input current	6 mA
Electrical isolation	galvanic isolation against the bus
<b>Outputs</b>	
Number of channels	(16) DC actuators
Output voltage	18...30 VDC from load voltage
Output current per channel	1.4 A, short-circuit proof
Load type	resistive, inductive, lamp load
Switching frequency	≤ 250 Hz
Simultaneity factor	0.4
Electrical isolation	galvanic isolation against the bus
<b>Operating temperature</b>	- 25...55 °C

**Fieldbus M12 x 1**

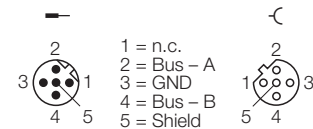

**Input M12 x 1**

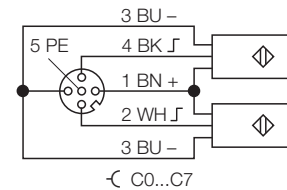

**Output M12 x 1**

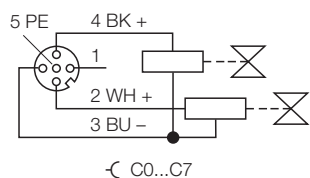

**Power supply 7/8"**

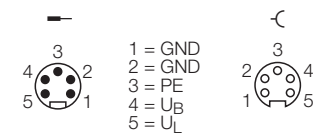

**Data in process image**

C1P4: Male Connector 1, 4-pole  
 SC: Short-circuit - group signal  
 SC3: Short-circuit channel 3  
 Con2: Overload sensor supply C2  
 UB: UB < 18 VDC  
 UL: UL < 18 VDC

		Bit 7	Bit 6	Bit 5	Bit 4	Bit 3	Bit 2	Bit 1	Bit 0
<b>Input</b>	<b>Byte 0</b>	C3P2	C3P4	C2P2	C2P4	C1P2	C1P4	C0P2	C0P4
	<b>Byte 1</b>	C7P2	C7P4	C6P2	C6P4	C5P2	C5P4	C4P2	C4P4
<b>Output</b>	<b>Byte 0</b>	C3P2	C3P4	C2P2	C2P4	C1P2	C1P4	C0P2	C0P4
	<b>Byte 1</b>	C7P2	C7P4	C6P2	C6P4	C5P2	C5P4	C4P2	C4P4
<b>Diagnostics</b>	<b>Byte 0</b>	-	-	-	-	-	UB	UL	SC
	<b>Byte 1</b>	SC 7	SC 6	SC 5	SC 4	SC 3	SC 2	SC 1	SC 0
	<b>Byte 2</b>	SC 15	SC 14	SC 13	SC 12	SC 11	SC 10	SC 9	SC 8
	<b>Byte 3</b>	Con 7	Con 6	Con 5	Con 4	Con 3	Con 2	Con 1	Con 0

# Compact fieldbus I/O modules in IP67 for PROFIBUS-DP

**TURCK**

Industrial  
Automation

## Series FGDP – general information



The compact FGDP series fieldbus I/O modules allow direct connection of up to 16 inputs/outputs to a PROFIBUS-DP network. The I/O modules offer channel-specific short-circuit diagnostics of the outputs and module specific short-circuit diagnostics of the inputs. The diagnostics can also be mapped to the user data area.

The operating and load supply are fed separately to the module and are galvanically isolated from each other. If the load supply is switched off, the module electronics and all inputs continue operation when the outputs are turned off. In this case, the load voltage diagnostics can also be deactivated.

The I/O modules support transmission rates of 12 Mbps. The PROFIBUS-DP connection is implemented via 5-pole, reverse-keyed M12 x 1 connectors. The module is powered via a 7/8" round connector and can be fed through via a second 7/8" round connector. The I/O level is equipped throughout with metal M12 connectors.

Glass-fibre reinforced plastic housings and the fully encapsulated module electronics guarantee protection degree IP67. The I/O modules are therefore particularly suited for use in harsh industrial environments.

### General technical data

#### Characteristics

Extended diagnostics, connector-specific short-circuit diagnostics of the sensor supply voltage, Channel specific short-circuit monitoring of the outputs, Complete diagnostic information according to standards via the PROFIBUS-DP, Channel-specific display of errors and status indications via LEDs, diagnostics can be mapped to user data area (diagnostic inputs), Galvanic isolation of operating and load voltage.

#### Settings

PROFIBUS-DP address 1...126 (decimal) adjustable via three coded rotary switches  
Transmission rate 9.6 kbps up to 12 Mbps, automatic

#### LEDs

Bus (dual colour LED) green: communication, red: no communication  
Power (dual colour LED) green: operational, off: UB < 18 VDC, red: UL < 18V (modules with digital outputs)  
Inputs (dual colour LED) green: ON, red: short-circuit  
Outputs (dual colour LED) green: ON, red: short-circuit

#### Connections

Nickel-plated brass  
PROFIBUS 1 x male M12 connector (IN), 1 x female M12 connector (OUT), 5-pole, reverse-keyed  
Power supply 1 x 7/8" male connector (IN), 1 x 7/8" female connector (OUT), 5-pole  
Inputs/outputs 8 female M12 x 1 connectors; 5-pole

#### Housing

PA6-GF30, glass-fibre reinforced plastic housing with encapsulated electronics and nickel-plated brass connectors  
Mounting via 4 through-holes, Ø 5.4 mm  
Degree of protection (IEC 60529/EN 60529) IP67  
Vibration and shock testing according to EN 60068-2-6, 2-27  
EMC acc.to EN 61000-6-2, IEC 61000-6-4  
Temperature range  
– Operating temperature 0 °C to +55 °C (+32 °F to +131 °F)  
– Storage and transport temperature -25 °C to +70 °C (-13 °F to +158 °F)  
Dimensions 220.5 x 62.4 x 27 mm (H x W x D)

#### Approvals



# Fieldbus I/O module PROFIBUS-DP

## 16 digital pnp inputs

### FGDP-IM16-0001

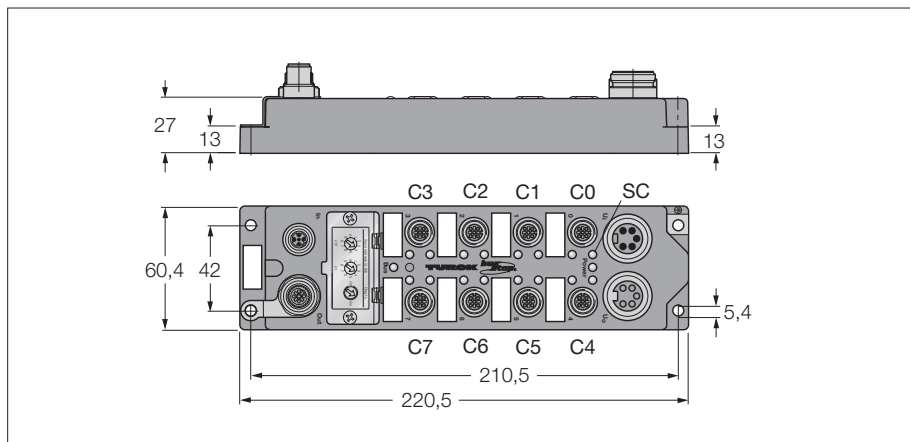

- 16 digital pnp inputs
- Galvanic isolated power supply
- Diagnostics can be mapped in user data
- Input diagnostics per slot
- Two channels per connector
- Fibre-glass reinforced PA6 housing
- Vibration and shock-resistant
- Encapsulated module electronics
- Metal connector
- Degree of protection IP67

<b>Type</b>	FGDP-IM16-0001
Ident-No.	6825368
<b>Operating / load voltage</b>	18...30 VDC
Operating current	< 60 mA
Electrical isolation	operational to load voltage
$C_{GND/FE}$	< 10 nF
$R_{GND/FE}$	> 20 MΩ
<b>Fieldbus transmission rate</b>	9.6 kbps up to 12 Mbps
Fieldbus addressing	1...126 (decimal) via three coded rotary switches
Electrical isolation	to operating and load voltage
<b>Inputs</b>	
Number of channels	(16) 3-wire pnp sensors
Input voltage	18...30 VDC via operating voltage
Supply current	< 120 mA per channel, short-circuit proof
Switching threshold	2 mA / 4 mA
Input delay	2.5 ms
Switching frequency	≤ 40 Hz
Max. input current	6 mA
Electrical isolation	galvanic isolation against the bus
<b>Operating temperature</b>	0 to 55 °C

#### Fieldbus M12 x 1

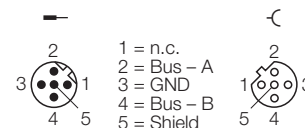

#### Input M12 x 1

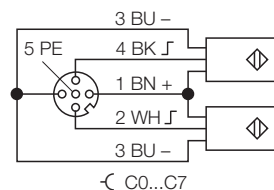

#### Power supply 7/8"

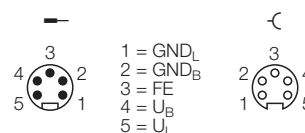

#### Data in process image

C1P4: Male Connector 1, 4-pole  
 SC: Short-circuit - group signal  
 SC3: Short-circuit channel 3:  
 Con2: Overload sensor supply C2  
 UB: UB < 18 VDC

		Bit 7	Bit 6	Bit 5	Bit 4	Bit 3	Bit 2	Bit 1	Bit 0
Input	Byte 0	C3P2	C3P4	C2P2	C2P4	C1P2	C1P4	C0P2	C0P4
	Byte 1	C7P2	C7P4	C6P2	C6P4	C5P2	C5P4	C4P2	C4P4
Diagnostics <sup>1)</sup>	Byte 0	-	-	-	-	-	UB	UL	SC
	Byte 1	SC 7	SC 6	SC 5	SC 4	SC 3	SC 2	SC 1	SC 0
	Byte 2	SC 15	SC 14	SC 13	SC 12	SC 11	SC 10	SC 9	SC 8
	Byte 3	Con 7	Con 6	Con 5	Con 4	Con 3	Con 2	Con 1	Con 0

<sup>1)</sup> The manufacturer-specific diagnostics can be fully mapped to the user data area via the configuration menu.



**Fieldbus I/O module PROFIBUS-DP**  
**8 digital pnp inputs**  
**8 digital outputs 1.4 A**  
**FGDP-IOM88-0001**

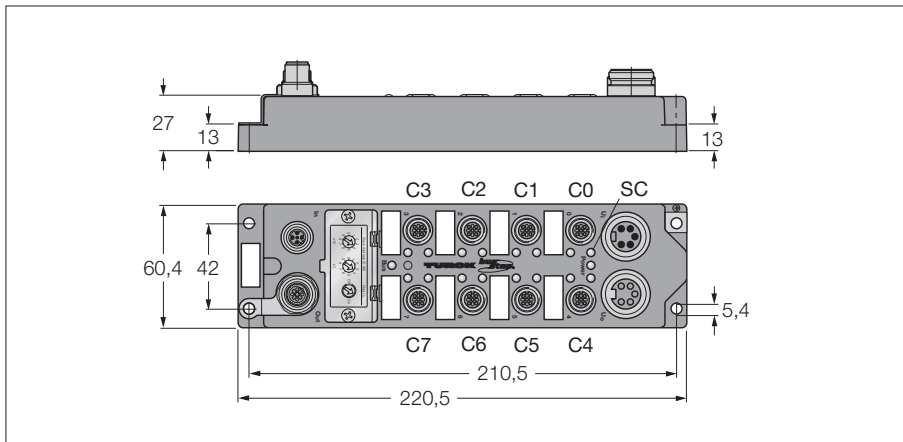

- 8 digital pnp inputs
- and 8 digital outputs, 24 VDC 1.4 A
- Galvanic isolated power supply
- Diagnostics can be mapped in user data
- Input diagnostics per slot
- Two channels per connector
- Fibre-glass reinforced PA6 housing
- Vibration and shock-resistant
- Encapsulated module electronics
- Metal connector
- Degree of protection IP67

<b>Type</b>	FGDP-IOM88-0001
<b>Ident-No.</b>	6825369
<b>Operating / load voltage</b>	18...30 VDC
<b>Operating current</b>	< 60 mA
<b>Electrical isolation</b>	operational to load voltage
$C_{GND/FE}$	< 10 nF
$R_{GND/FE}$	> 20 MΩ
<b>Fieldbus transmission rate</b>	9.6 kbps up to 12 Mbps
<b>Fieldbus addressing</b>	1...126 (decimal) via three coded rotary switches
<b>Electrical isolation</b>	to operating and load voltage
<b>Inputs</b>	
Number of channels	(8) 3-wire pnp sensors
Input voltage	18...30 VDC via operating voltage
Supply current	< 120 mA per channel, short-circuit proof
Switching threshold	2 mA / 4 mA
Input delay	2.5 ms
Switching frequency	≤ 40 Hz
Max. input current	6 mA
Electrical isolation	galvanic isolation against the bus and outputs
<b>Outputs</b>	
Number of channels	(8) DC actuators
Output voltage	18...30 VDC from load voltage
Output current per channel	1.4 A, short-circuit proof
Load type	resistive, inductive, lamp load
Switching frequency	≤ 40 Hz
Simultaneity factor	0.8
Electrical isolation	galvanic isolation against the bus and outputs
<b>Operating temperature</b>	0 to 55 °C

**Fieldbus M12 x 1**

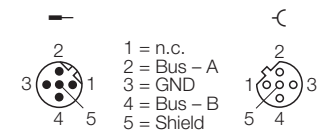

**Input M12 x 1**

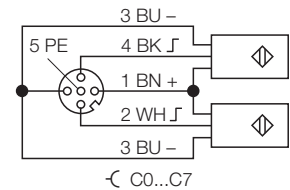

**Output M12 x 1**

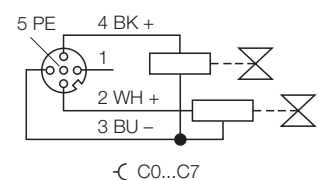

**Power supply 7/8"**



**Data in process image**

C1P4: Male Connector 1, 4-pole  
 SC: Short-circuit - group signal  
 SC3: Short-circuit channel 3:  
 Con2: Overload sensor supply C2  
 UB: UB < 18 VDC  
 UL: UL < 18 VDC

		Bit 7	Bit 6	Bit 5	Bit 4	Bit 3	Bit 2	Bit 1	Bit 0
<b>Input</b>	<b>Byte 0</b>	C3P2	C3P4	C2P2	C2P4	C1P2	C1P4	C0P2	C0P4
<b>Output</b>	<b>Byte 0</b>	C7P2	C7P4	C6P2	C6P4	C5P2	C5P4	C4P2	C4P4
<b>Diagnostics</b>	<b>Byte 0</b>	-	-	-	-	-	U <sub>B</sub>	U <sub>L</sub>	SC
	<b>Byte 1</b>	SC 7	SC 6	SC 5	SC 4	SC 3	SC 2	SC 1	SC 0
	<b>Byte 2</b>	SC 15	SC 14	SC 13	SC 12	SC 11	SC 10	SC 9	SC 8
	<b>Byte 3</b>	Con 7	Con 6	Con 5	Con 4	Con 3	Con 2	Con 1	Con 0

# Compact fieldbus I/O modules in IP67 for PROFIBUS-DP

## Series FLDP – general information



The compact fieldbus I/O modules of the FLDP series allow direct connection of up to 32 inputs/outputs to a PROFIBUS-DP network. The I/O modules offer module-specific short-circuit diagnostics of the inputs and outputs.

Operating and load voltage are fed separately. If the load supply is switched off, the module electronics and all inputs continue operation when the outputs are turned off. In this case, the load voltage diagnostics can also be deactivated. The I/O modules support transmission rates of 12 Mbps.

The PROFIBUS-DP connection is implemented via 5-pole, reverse-keyed M12 x 1 round connectors. The module is powered via a 7/8" round connector and can be fed through via a second 7/8" round connector. The I/O level is equipped throughout with M12 metal round connectors.

Glass-fibre reinforced plastic housings and the fully encapsulated module electronics guarantee protection degree IP67. The I/O modules are therefore particularly suited for use in harsh industrial environments.

### General technical data

#### Characteristics

Load voltage diagnostics can be disabled via rotary switch, common short-circuit diagnostics

#### Settings

PROFIBUS-DP address 1...99 (decimal) adjustable via two coded rotary switches  
 Load voltage diagnostics can be disabled via coded rotary switch (modules with digital outputs only)  
 Transmission rate 9.6 kbps up to 12 Mbps, automatic

#### LEDs

Bus (dual colour LED) green: communication, red: no communication  
 Power (dual colour LED) green: operational, off: UB < 18 VDC  
 red: UL < 18 V (modules with digital outputs)  
 Inputs green: ON  
 Outputs green: ON  
 Common short-circuit indication red: short-circuit at one input

#### Connections

PROFIBUS brass, nickel-plated  
 M12 x 1 connectors, reverse-keyed  
 Power supply 7/8" connector, 5-pole or  
 Inputs/outputs female M12 x 1 connectors; 5-pole  
 – FLDP-IOM2012-0001 only: 2 x 19-pole Burndy connectors

#### Housing material

PA6-GF30, glass-fibre reinforced plastic housing with encapsulated electronics and nickel-plated brass connectors  
 Mounting 4 through-holes, Ø 5.4 mm  
 Degree of protection (IEC 60529/EN 60529) IP67 (NEMA 1, 3, 4, 12, 13)  
 Vibration and shock tested according to EN 60068-2-6, 2-27  
 Temperature range 0 °C to +55 °C (+32 °F to +131 °F)  
 Dimensions  
 – Housings for modules with 8, 12 and 16 channels 220.5 x 62.4 x 27 mm (H x W x D)  
 – Housing for modules with 32 channels 220.5 x 115 x 27 mm (H x W x D)

#### Approvals



**Fieldbus I/O module PROFIBUS-DP**  
**8 digital pnp inputs**  
**FLDP-IM8-0001**

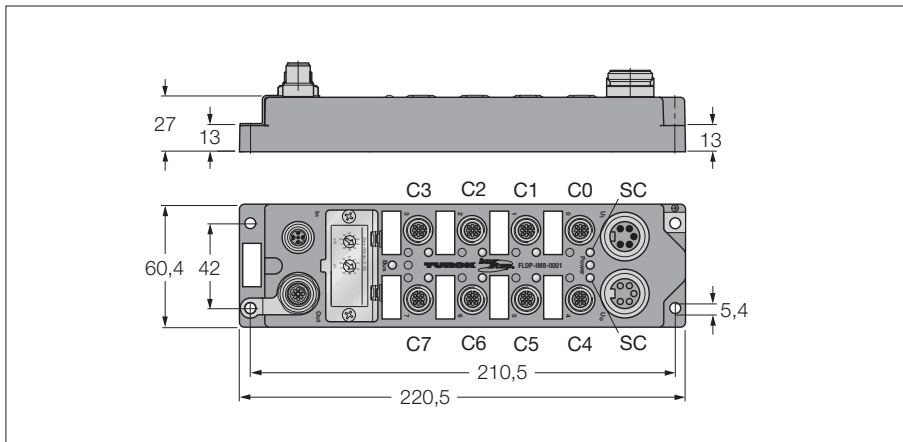

- 8 digital pnp inputs
- Module-related diagnostics
- One channel per connector
- Fibre-glass reinforced PA6 housing
- Vibration and shock-resistant
- Encapsulated module electronics
- Metal connector
- Degree of protection IP67

<b>Type</b>	FLDP-IM8-0001
Ident-No.	6825320
<b>Operating / load voltage</b>	18...30 VDC
Operating current	< 110 mA
<b>Fieldbus transmission rate</b>	9.6 kbps up to 12 Mbps
Fieldbus addressing	1...126 (decimal) via three coded rotary switches
Electrical isolation	to operating and load voltage
<b>Inputs</b>	
Number of channels	(8) 2/3-wire pnp sensors
Input voltage	18...30 VDC via operating voltage
Supply current	< 500 mA 4 channel each, short-circuit proof
Switching threshold	2 mA / 4 mA
Input delay	2.5 ms
Switching frequency	≤ 250 Hz
Max. input current	6 mA
Electrical isolation	galvanic isolation against the bus
<b>Operating temperature</b>	0 to 55 °C

**Fieldbus M12 x 1**

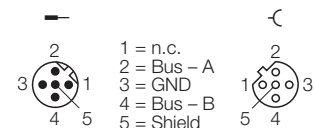

**Input M12 x 1**

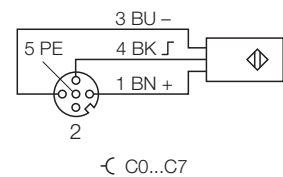

**Power supply 7/8"**

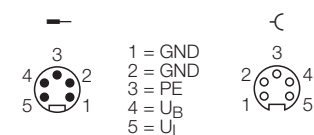

**Data in process image**

C1P4: Male Connector 1, 4-pole  
 SC: Short-circuit - group signal  
 UB: UB < 18 VDC

		Bit 7	Bit 6	Bit 5	Bit 4	Bit 3	Bit 2	Bit 1	Bit 0
<b>Input</b>	<b>Byte 0</b>	C7P4	C6P4	C5P4	C4P4	C3P4	C2P4	C1P4	C0P4
<b>Diagnostics</b>	<b>Byte 0</b>	-	-	-	-	-	UB	-	SC



# Fieldbus I/O module PROFIBUS-DP

## 16 digital pnp inputs

### FLDP-IM16-0001

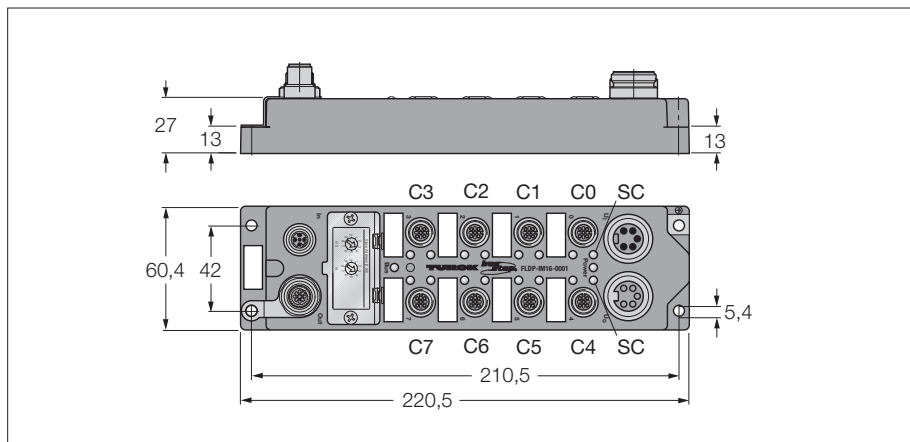

- 16 digital pnp inputs
- Module-related diagnostics
- Two channels per connector
- Fibre-glass reinforced PA6 housing
- Vibration and shock-resistant
- Encapsulated module electronics
- Metal connector
- Degree of protection IP67

<b>Type</b>	FLDP-IM16-0001
Ident-No.	6825326
<b>Operating / load voltage</b>	18...30 VDC
Operating current	< 110 mA
<b>Fieldbus transmission rate</b>	9.6 kbps up to 12 Mbps
Fieldbus addressing	1...126 (decimal) via three coded rotary switches
Electrical isolation	to operating and load voltage
<b>Inputs</b>	
Number of channels	(16) 2/3-wire pnp sensors
Input voltage	18...30 VDC via operating voltage
Supply current	< 500 mA 8 channel each, short-circuit proof
Switching threshold	2 mA / 4 mA
Input delay	2.5 ms
Switching frequency	≤ 250 Hz
Max. input current	6 mA
Electrical isolation	galvanic isolation against the bus
<b>Operating temperature</b>	0 to 55 °C

#### Fieldbus M12 x 1

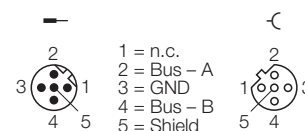

#### Input M12 x 1

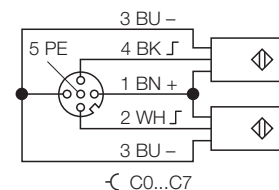

#### Power supply 7/8"

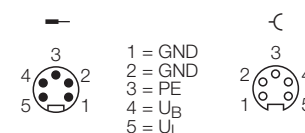

#### Data in process image

C1P4: Male Connector 1, 4-pole

SC: Short-circuit - group signal

UB: UB < 18 VDC

		Bit 7	Bit 6	Bit 5	Bit 4	Bit 3	Bit 2	Bit 1	Bit 0
Input	Byte 0	C3P2	C3P4	C2P2	C2P4	C1P2	C1P4	C0P2	C0P4
	Byte 1	C7P2	C7P4	C6P2	C6P4	C5P2	C5P4	C4P2	C4P4
Diagnostics	Byte 0	-	-	-	-	-	UB	-	SC

**Fieldbus I/O module PROFIBUS-DP**  
**32 digital pnp inputs**  
**FLDP-IM32-0001**

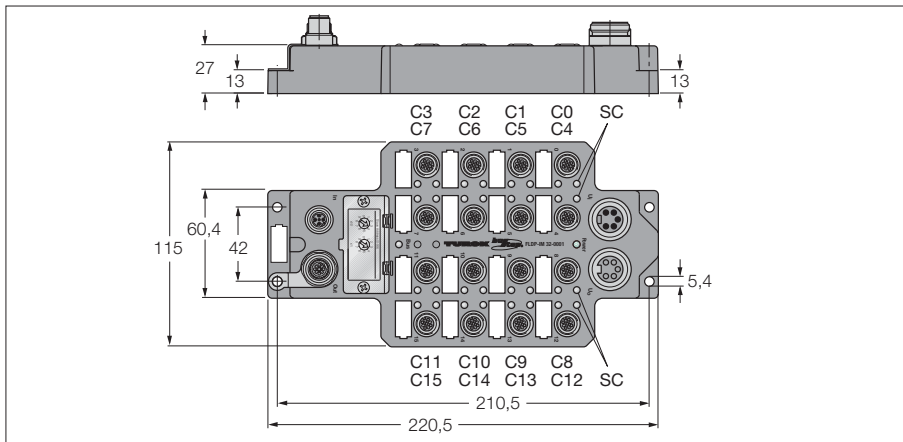

- 32 digital pnp inputs
- Module-related diagnostics
- Two channels per connector
- Fibre-glass reinforced PA6 housing
- Vibration and shock-resistant
- Encapsulated module electronics
- Metal connector
- Degree of protection IP67

<b>Type</b>	FLDP-IM32-0001
Ident-No.	6825332
<b>Operating / load voltage</b>	18...30 VDC
Operating current	< 110 mA
<b>Fieldbus transmission rate</b>	9.6 kbps up to 12 Mbps
Fieldbus addressing	1...126 (decimal) via three coded rotary switches
Electrical isolation	to operating and load voltage
<b>Inputs</b>	
Number of channels	(32) 3-wire pnp sensors
Input voltage	18...30 VDC via operating voltage
Supply current	< 500 mA 8 channel each, short-circuit proof
Switching threshold	2 mA / 4 mA
Input delay	2.5 ms
Switching frequency	≤ 250 Hz
Max. input current	6 mA
Electrical isolation	galvanic isolation against the bus
<b>Operating temperature</b>	0 to 55 °C

**Fieldbus M12 x 1**

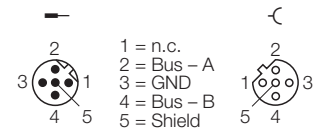

**Input M12 x 1**

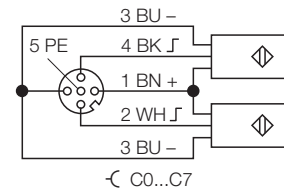

**Power supply 7/8"**

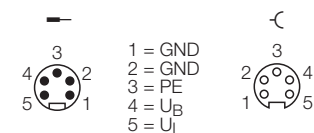

**Data in process image**

C1P4: Male Connector 1, 4-pole  
 SC: Short-circuit - group signal  
 UB: UB < 18 VDC

		Bit 7	Bit 6	Bit 5	Bit 4	Bit 3	Bit 2	Bit 1	Bit 0
<b>Input</b>	<b>Byte 0</b>	C3P2	C3P4	C2P2	C2P4	C1P2	C1P4	C0P2	C0P4
	<b>Byte 1</b>	C7P2	C7P4	C6P2	C6P4	C5P2	C5P4	C4P2	C4P4
	<b>Byte 2</b>	C11P2	C11P4	C10P2	C10P4	C9P2	C9P4	C8P2	C8P4
	<b>Byte 3</b>	C15P2	C15P4	C14P2	C14P4	C13P2	C13P4	C12P2	C12P4
<b>Diagnostics</b>	<b>Byte 0</b>	-	-	-	-	-	UB	-	SC



# Fieldbus I/O module PROFIBUS-DP

## 8 digital outputs 0.5 A

### FLDP-OM8-0001

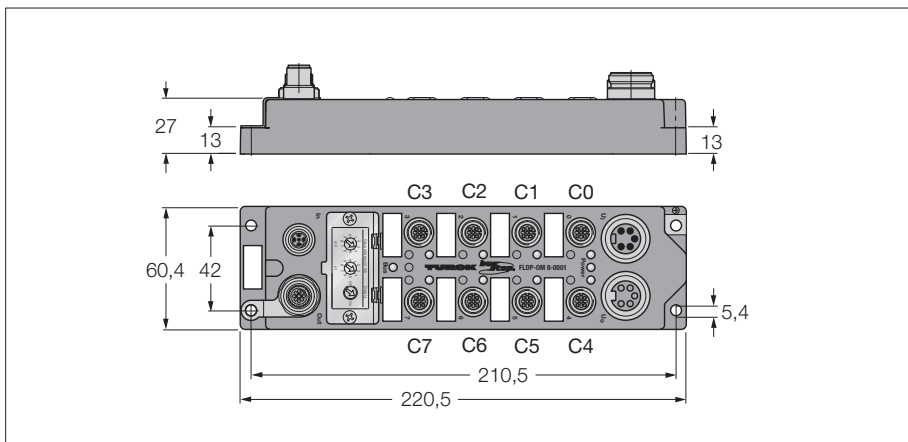

- 8 digital outputs, 0.5 A
- Module-related diagnostics
- One channel per connector
- Fibre-glass reinforced PA6 housing
- Vibration and shock-resistant
- Encapsulated module electronics
- Metal connector
- Degree of protection IP67

<b>Type</b>	FLDP-OM8-0001
Ident-No.	6825321
<b>Operating / load voltage</b>	18...30 VDC
Operating current	< 150 mA
<b>Fieldbus transmission rate</b>	9.6 kbps up to 12 Mbps
Fieldbus addressing	1...126 (decimal) via three coded rotary switches
Electrical isolation	to operating and load voltage
<b>Outputs</b>	
Number of channels	(8) DC actuators
Output voltage	18...30 VDC from load voltage
Output current per channel	0.5 A, short-circuit proof
Load type	resistive, inductive, lamp load
Switching frequency	≤ 250 Hz
Simultaneity factor	1
Electrical isolation	galvanic isolation against the bus
<b>Operating temperature</b>	0 to 55 °C

#### Fieldbus M12 x 1

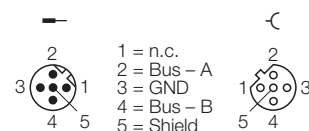

#### Output M12 x 1

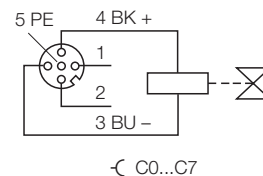

#### Power supply 7/8"

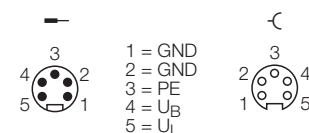

#### Data in process image

C1P4: Male Connector 1, 4-pole

SC: Short-circuit - group signal

UB: UB < 18 VDC

UL: UL < 18 VDC

		Bit 7	Bit 6	Bit 5	Bit 4	Bit 3	Bit 2	Bit 1	Bit 0
<b>Output</b>	<b>Byte 0</b>	C7P4	C6P4	C5P4	C4P4	C3P4	C2P4	C1P4	C0P4
<b>Diagnostics</b>	<b>Byte 0</b>	-	-	-	-	-	UB	UL	-

**Fieldbus I/O module PROFIBUS-DP  
8 digital outputs 2 A  
FLDP-OM8-0002**

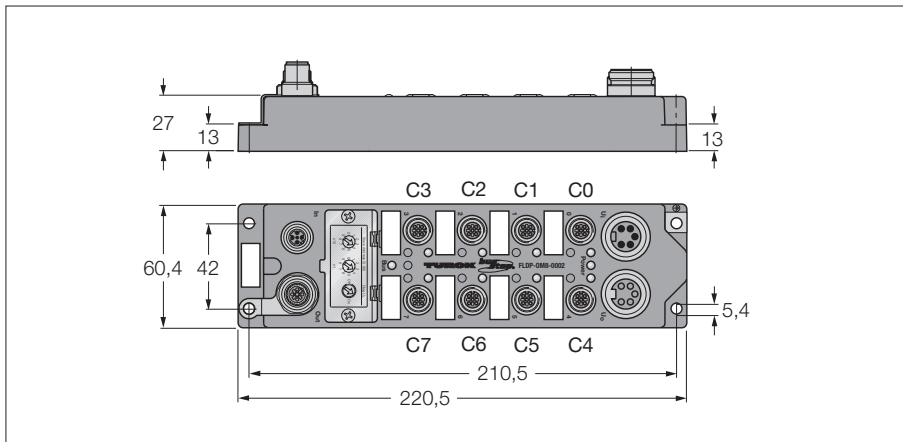

- 8 digital outputs, 2 A
- Module-related diagnostics
- One channel per connector
- Fibre-glass reinforced PA6 housing
- Vibration and shock-resistant
- Encapsulated module electronics
- Metal connector
- Degree of protection IP67

<b>Type</b>	FLDP-OM8-0002
Ident-No.	6825331
<b>Operating / load voltage</b>	18...30 VDC
Operating current	< 150 mA
<b>Fieldbus transmission rate</b>	9.6 kbps up to 12 Mbps
Fieldbus addressing	1...126 (decimal) via three coded rotary switches
Electrical isolation	to operating and load voltage
<b>Outputs</b>	
Number of channels	(8) DC actuators
Output voltage	18...30 VDC from load voltage
Output current per channel	2.0 A, short-circuit proof
Load type	resistive, inductive, lamp load
Switching frequency	≤ 250 Hz
Simultaneity factor	0.5
Electrical isolation	galvanic isolation against the bus
<b>Operating temperature</b>	0 to 55 °C

**Fieldbus M12 x 1**

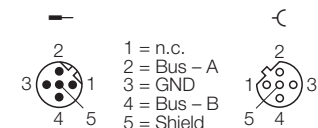

**Output M12 x 1**

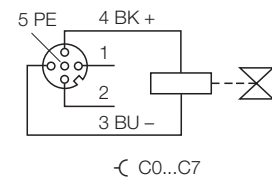

**Power supply 7/8"**

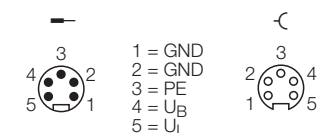

**Data in process image**

C1P4: Male Connector 1, 4-pole  
SC: Short-circuit - group signal  
UB: UB < 18 VDC  
UL: UL < 18 VDC

		Bit 7	Bit 6	Bit 5	Bit 4	Bit 3	Bit 2	Bit 1	Bit 0
<b>Output</b>	<b>Byte 0</b>	C7P4	C6P4	C5P4	C4P4	C3P4	C2P4	C1P4	C0P4
<b>Diagnostics</b>	<b>Byte 0</b>	-	-	-	-	-	UB	UL	-

# Fieldbus I/O module PROFIBUS-DP

## 16 digital outputs 0.5 A

### FLDP-OM16-0001

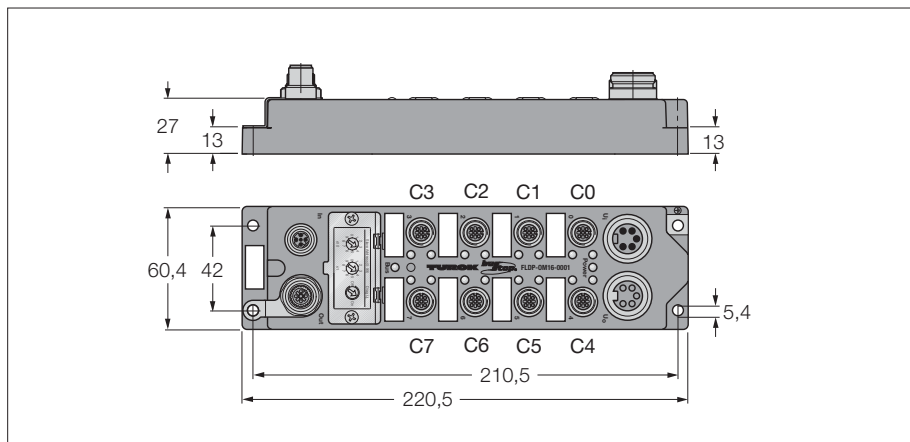

- 16 digital outputs, 0.5 A
- Module-related diagnostics
- Two channels per connector
- Fibre-glass reinforced PA6 housing
- Vibration and shock-resistant
- Encapsulated module electronics
- Metal connector
- Degree of protection IP67

<b>Type</b>	FLDP-OM16-0001
Ident-No.	6825327
<b>Operating / load voltage</b>	18...30 VDC
Operating current	< 150 mA
<b>Fieldbus transmission rate</b>	9.6 kbps up to 12 Mbps
Fieldbus addressing	1...126 (decimal) via three coded rotary switches
Electrical isolation	to operating and load voltage
<b>Outputs</b>	
Number of channels	(16) DC actuators
Output voltage	18...30 VDC from load voltage
Output current per channel	0.5 A, short-circuit proof
Load type	resistive, inductive, lamp load
Switching frequency	≤ 250 Hz
Simultaneity factor	1
Electrical isolation	galvanic isolation against the bus
<b>Operating temperature</b>	0 to 55 °C

#### Fieldbus M12 x 1

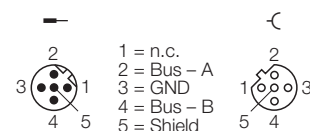

#### Output M12 x 1

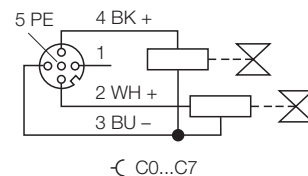

#### Power supply 7/8"

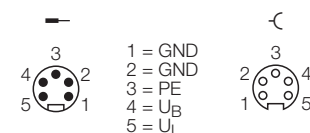

#### Data in process image

C1P4: Male Connector 1, 4-pole

SC: Short-circuit - group signal

UB: UB < 18 VDC

UL: UL < 18 VDC

		Bit 7	Bit 6	Bit 5	Bit 4	Bit 3	Bit 2	Bit 1	Bit 0
Output	Byte 0	C3P2	C3P4	C2P2	C2P4	C1P2	C1P4	C0P2	C0P4
	Byte 1	C7P2	C7P4	C6P2	C6P4	C5P2	C5P4	C4P2	C4P4
Diagnostics	Byte 0	-	-	-	-	-	UB	UL	-



**Fieldbus I/O module PROFIBUS-DP**  
**8 digital pnp inputs**  
**4 digital outputs 2 A**  
**FLDP-IOM84-0001**

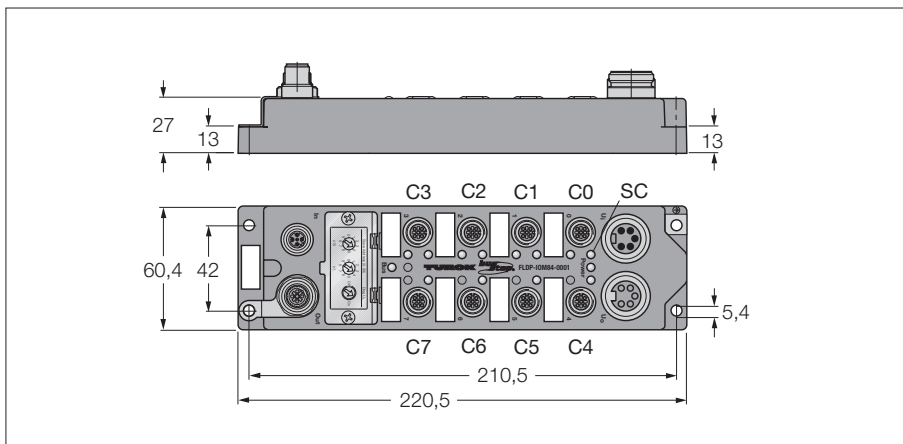

- 8 digital pnp inputs
- 4 digital outputs 2 A
- Module-related diagnostics
- Fibre-glass reinforced PA6 housing
- Vibration and shock-resistant
- Encapsulated module electronics
- Metal connector
- Degree of protection IP67

<b>Type</b>	FLDP-IOM84-0001
<b>Ident-No.</b>	6825330
<b>Operating / load voltage</b>	18...30 VDC
<b>Operating current</b>	< 150 mA
<b>Fieldbus transmission rate</b>	9.6 kbps up to 12 Mbps
<b>Fieldbus addressing</b>	1...126 (decimal) via three coded rotary switches
<b>Electrical isolation</b>	to operating and load voltage
<b>Inputs</b>	
Number of channels	(8) 2/3-wire pnp sensors
Input voltage	18...30 VDC via operating voltage
Supply current	< 500 mA 8 channel each, short-circuit proof
Switching threshold	2 mA / 4 mA
Input delay	2.5 ms
Switching frequency	≤ 250 Hz
Max. input current	6 mA
Electrical isolation	galvanic isolation against the bus
<b>Outputs</b>	
Number of channels	(4) DC actuators
Output voltage	18...30 VDC from load voltage
Output current per channel	2.0 A, short-circuit proof
Load type	resistive, inductive, lamp load
Switching frequency	≤ 250 Hz
Simultaneity factor	1
Electrical isolation	galvanic isolation against the bus
<b>Operating temperature</b>	0 to 55 °C

**Fieldbus M12 x 1**

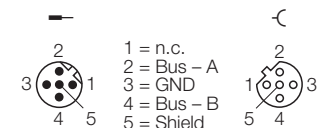

**Input M12 x 1**

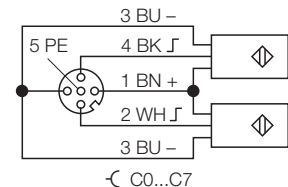

**Output M12 x 1**

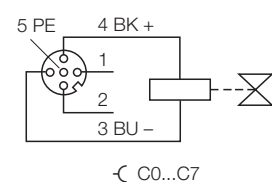

**Power supply 7/8"**

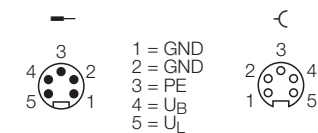

**Data in process image**

C1P4: Male Connector 1, 4-pole  
 SC: Short-circuit - group signal  
 UB: UB < 18 VDC  
 UL: UL < 18 VDC

		Bit 7	Bit 6	Bit 5	Bit 4	Bit 3	Bit 2	Bit 1	Bit 0
<b>Input</b>	<b>Byte 0</b>	C3P2	C3P4	C2P2	C2P4	C1P2	C1P4	C0P2	C0P4
<b>Output</b>	<b>Byte 0</b>	-	C7P4	-	C6P4	-	C5P4	-	C4P4
<b>Diagnostics</b>	<b>Byte 0</b>	-	-	-	-	-	UB	UL	SC

# Fieldbus I/O module PROFIBUS-DP

**8 digital pnp inputs**  
**8 digital outputs 0.5 A**  
**FLDP-IOM88-0001**

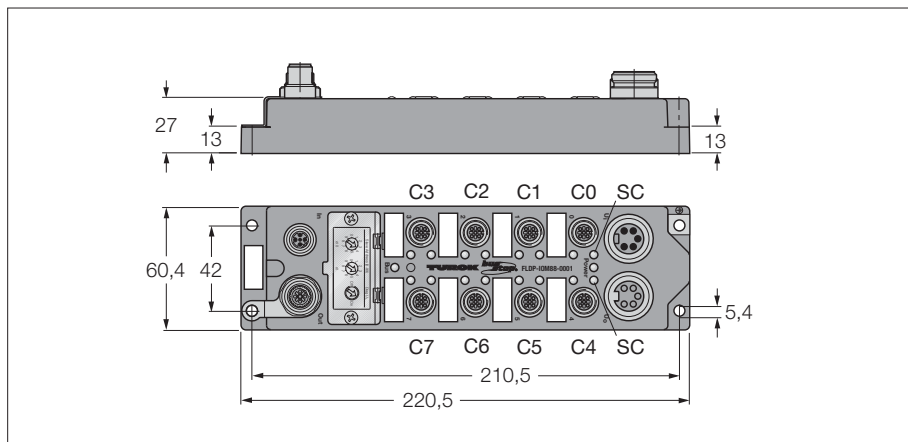

- 8 digital pnp inputs
- 8 digital outputs 0.5 A
- Module-related diagnostics
- Two channels per connector
- Fibre-glass reinforced PA6 housing
- Vibration and shock-resistant
- Encapsulated module electronics
- Metal connector
- Degree of protection IP67

<b>Type</b>	FLDP-IOM88-0001
Ident-No.	6825322
<b>Operating / load voltage</b>	18...30 VDC
Operating current	< 150 mA
<b>Fieldbus transmission rate</b>	9.6 kbps up to 12 Mbps
Fieldbus addressing	1...126 (decimal) via three coded rotary switches
Electrical isolation	to operating and load voltage
<b>Inputs</b>	
Number of channels	(8) 2/3-wire pnp sensors
Input voltage	18...30 VDC via operating voltage
Supply current	< 500 mA 4 channel each, short-circuit proof
Switching threshold	2 mA / 4 mA
Input delay	2.5 ms
Switching frequency	≤ 250 Hz
Max. input current	6 mA
Electrical isolation	galvanic isolation against the bus
<b>Outputs</b>	
Number of channels	(8) DC actuators
Output voltage	18...30 VDC from load voltage
Output current per channel	0.5 A, short-circuit proof
Load type	resistive, inductive, lamp load
Switching frequency	≤ 250 Hz
Simultaneity factor	1
Electrical isolation	galvanic isolation against the bus
<b>Operating temperature</b>	0 to 55 °C

### Fieldbus M12 x 1

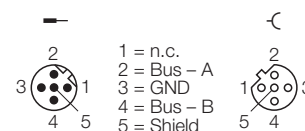

### Input M12 x 1

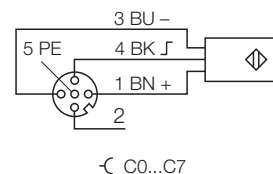

### Output M12 x 1

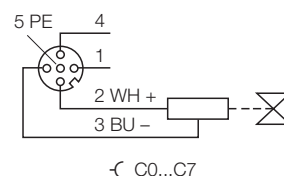

### Power supply 7/8"

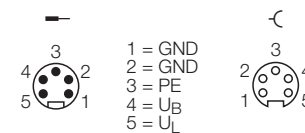

### Data in process image

C1P4: Male Connector 1, 4-pole  
 SC: Short-circuit - group signal  
 UB: UB < 18 VDC  
 UL: UL < 18 VDC

		Bit 7	Bit 6	Bit 5	Bit 4	Bit 3	Bit 2	Bit 1	Bit 0
<b>Input</b>	<b>Byte 0</b>	C7P4	C6P4	C5P4	C4P4	C3P4	C2P4	C1P4	C0P4
<b>Output</b>	<b>Byte 0</b>	C7P2	C6P2	C5P2	C4P2	C3P2	C2P2	C1P2	C0P2
<b>Diagnostics</b>	<b>Byte 0</b>	-	-	-	-	-	UB	UL	SC

**Fieldbus I/O module PROFIBUS-DP**  
**8 digital pnp inputs**  
**8 digital outputs 0.5 A**  
**FLDP-IOM88-0002**

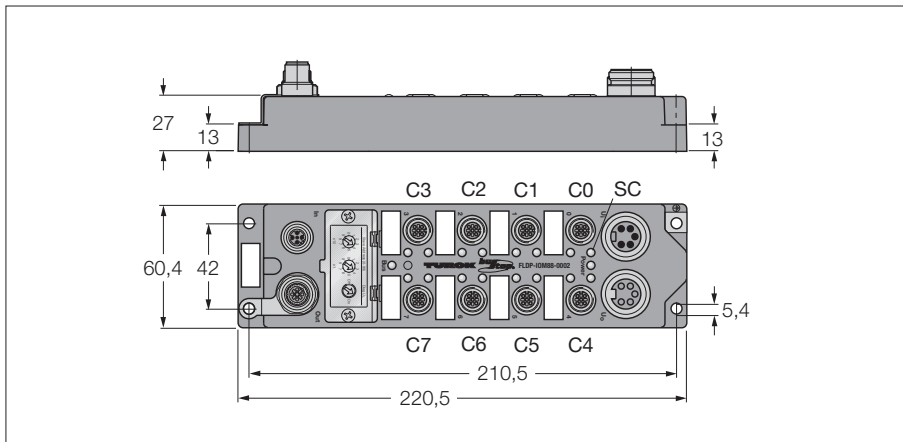

- 8 digital pnp inputs
- 8 digital outputs 0.5 A
- Module-related diagnostics
- Two channels per connector
- Fibre-glass reinforced PA6 housing
- Vibration and shock-resistant
- Encapsulated module electronics
- Metal connector
- Degree of protection IP67

<b>Type</b>	FLDP-IOM88-0002
<b>Ident-No.</b>	6825323
<b>Operating / load voltage</b>	18...30 VDC
<b>Operating current</b>	< 150 mA
<b>Fieldbus transmission rate</b>	9.6 kbps up to 12 Mbps
<b>Fieldbus addressing</b>	1...126 (decimal) via three coded rotary switches
<b>Electrical isolation</b>	to operating and load voltage
<b>Inputs</b>	
Number of channels	(8) 2/3-wire pnp sensors
Input voltage	18...30 VDC via operating voltage
Supply current	< 500 mA 8 channel each, short-circuit proof
Switching threshold	2 mA / 4 mA
Input delay	2.5 ms
Switching frequency	≤ 250 Hz
Max. input current	6 mA
Electrical isolation	galvanic isolation against the bus
<b>Outputs</b>	
Number of channels	(8) DC actuators
Output voltage	18...30 VDC from load voltage
Output current per channel	0.5 A, short-circuit proof
Load type	resistive, inductive, lamp load
Switching frequency	≤ 250 Hz
Simultaneity factor	1
Electrical isolation	galvanic isolation against the bus
<b>Operating temperature</b>	0 to 55 °C

**Fieldbus M12 x 1**

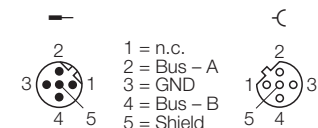

**Input M12 x 1**

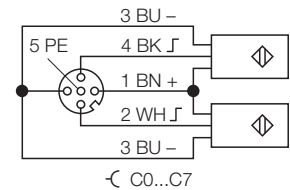

**Output M12 x 1**

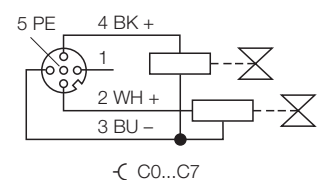

**Power supply 7/8"**

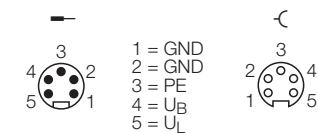

**Data in process image**

C1P4: Male Connector 1, 4-pole  
 SC: Short-circuit - group signal  
 UB: UB < 18 VDC  
 UL: UL < 18 VDC

		Bit 7	Bit 6	Bit 5	Bit 4	Bit 3	Bit 2	Bit 1	Bit 0
<b>Input</b>	<b>Byte 0</b>	C3P2	C3P4	C2P2	C2P4	C1P2	C1P4	C0P2	C0P4
<b>Output</b>	<b>Byte 0</b>	C7P2	C7P4	C6P2	C6P4	C5P2	C5P4	C4P2	C4P4
<b>Diagnostics</b>	<b>Byte 0</b>	-	-	-	-	-	UB	UL	SC

# Fieldbus I/O module PROFIBUS-DP

**16 digital pnp inputs**  
**16 digital outputs 0.5 A**  
**FLDP-IOM1616-0001**

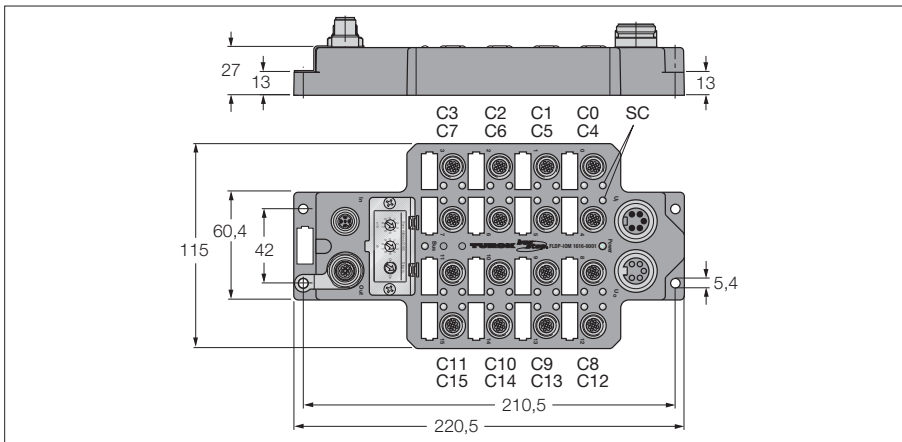

- 16 digital pnp inputs
- 16 digital outputs 0.5 A
- Module-related diagnostics
- Two channels per connector
- Fibre-glass reinforced PA6 housing
- Vibration and shock-resistant
- Encapsulated module electronics
- Metal connector
- Degree of protection IP67

<b>Type</b>	FLDP-IOM1616-0001
Ident-No.	6825338
<b>Operating / load voltage</b>	18...30 VDC
Operating current	< 150 mA
<b>Fieldbus transmission rate</b>	9.6 kbps up to 12 Mbps
Fieldbus addressing	1...126 (decimal) via three coded rotary switches
Electrical isolation	to operating and load voltage
<b>Inputs</b>	
Number of channels	(16) 3-wire pnp sensors
Input voltage	18...30 VDC via operating voltage
Supply current	< 500 mA 8 channel each, short-circuit proof
Switching threshold	2 mA / 4 mA
Input delay	2.5 ms
Switching frequency	≤ 250 Hz
Max. input current	6 mA
Electrical isolation	galvanic isolation against the bus
<b>Outputs</b>	
Number of channels	(16) DC actuators
Output voltage	18...30 VDC from load voltage
Output current per channel	0.5 A, short-circuit proof
Load type	resistive, inductive, lamp load
Switching frequency	≤ 250 Hz
Simultaneity factor	1
Electrical isolation	galvanic isolation against the bus
<b>Operating temperature</b>	0 to 55 °C

### Fieldbus M12 x 1

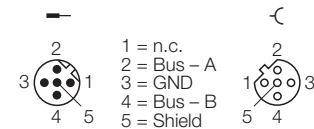

### Input M12 x 1

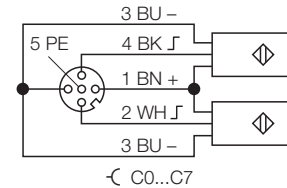

### Output M12 x 1

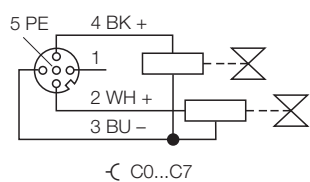

### Power supply 7/8"

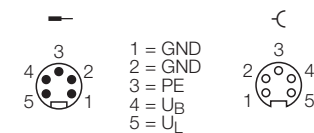

### Data in process image

C1P4: Male Connector 1, 4-pole  
 SC: Short-circuit - group signal  
 UB: UB < 18 VDC  
 UL: UL < 18 VDC

		Bit 7	Bit 6	Bit 5	Bit 4	Bit 3	Bit 2	Bit 1	Bit 0
Input	Byte 0	C3P2	C3P4	C2P2	C2P4	C1P2	C1P4	C0P2	C0P4
	Byte 1	C7P2	C7P4	C6P2	C6P4	C5P2	C5P4	C4P2	C4P4
Output	Byte 0	C11P2	C11P4	C10P2	C10P4	C9P2	C9P4	C8P2	C8P4
	Byte 1	C15P2	C15P4	C14P2	C14P4	C13P2	C13P4	C12P2	C12P4
Diagnostics	Byte 0	-	-	-	-	-	UB	UL	SC

**Fieldbus I/O module PROFIBUS-DP**  
**20 digital pnp inputs**  
**12 digital outputs 0.5 A**  
**FLDP-IOM2012-0001**

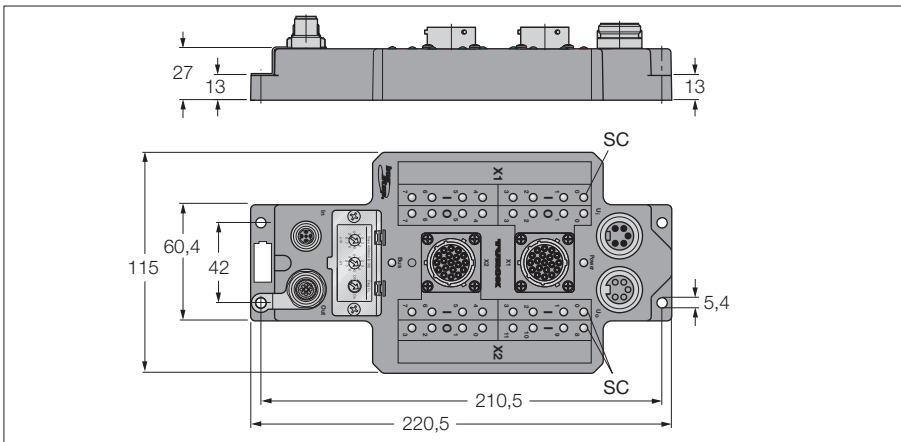

- 20 digital pnp inputs
- and 12 digital outputs, 24 VDC 0.5 A
- Module-related diagnostics
- Fibre-glass reinforced PA6 housing
- Vibration and shock-resistant
- Encapsulated module electronics
- Metal connector
- Degree of protection IP67

<b>Type</b>	FLDP-IOM2012-0001
Ident-No.	6825339
<b>Operating / load voltage</b>	18...30 VDC
Operating current	< 150 mA
<b>Fieldbus transmission rate</b>	9.6 kbps up to 12 Mbps
Fieldbus addressing	1...126 (decimal) via three coded rotary switches
Electrical isolation	to operating and load voltage
<b>Inputs</b>	
Number of channels	(20) 3-wire pnp sensors
Input voltage	18...30 VDC via operating voltage
Supply current	< 500 mA 8/12 channel each, short-circuit proof
Switching threshold	2 mA / 4 mA
Input delay	2.5 ms
Switching frequency	≤ 250 Hz
Max. input current	6 mA
Electrical isolation	galvanic isolation against the bus
<b>Outputs</b>	
Number of channels	(12) DC actuators
Output voltage	18...30 VDC from load voltage
Output current per channel	0.5 A, short-circuit proof
Load type	resistive, inductive, lamp load
Switching frequency	≤ 250 Hz
Simultaneity factor	1
Electrical isolation	galvanic isolation against the bus
<b>Operating temperature</b>	0 to 55 °C

**Fieldbus M12 x 1**

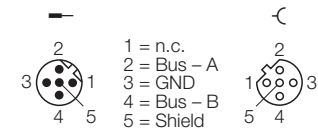

**Connection - Inputs**

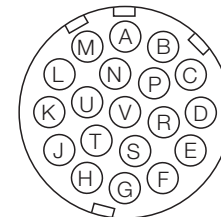

**Connection - Outputs**

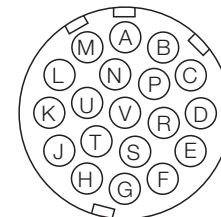

**Power supply 7/8"**

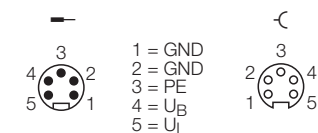

**Data in process image**

X114: Connector 1, input 4  
 X203: Connector, 2/3", output 3  
 SC: Short-circuit - group signal  
 UB: UB < 18 VDC  
 UL: UL < 18 VDC

		Bit 7	Bit 6	Bit 5	Bit 4	Bit 3	Bit 2	Bit 1	Bit 0
<b>Input</b>	<b>Byte 0</b>	X117	X116	X115	X114	X113	X112	X111	X110
	<b>Byte 1</b>	X217	X216	X215	X214	X213	X212	X211	X210
	<b>Byte 2</b>	-	-	-	-	X2111	X2110	X219	X218
<b>Output</b>	<b>Byte 0</b>	X107	X106	X105	X104	X103	X102	X101	X100
	<b>Byte 1</b>	-	-	-	-	X203	X202	X201	X200
<b>Diagnostics</b>	<b>Byte 0</b>	-	-	-	-	-	UB	UL	SC

**Fieldbus I/O module PROFIBUS-DP**  
**20 digital pnp inputs**  
**12 digital outputs 0.5 A**  
**FLDP-IOM2012-0001**

**Connection of input/output module FLDP-IOM2012 – junction 8FKS5P3**

Passive junction 8FKS5P3 ( X1 )  
 Ident-Nr. 8008720

Input/output module FLDP-IOM2012

Passive junction 8FKS5P3 ( X2 )  
 Ident-Nr. 8008720

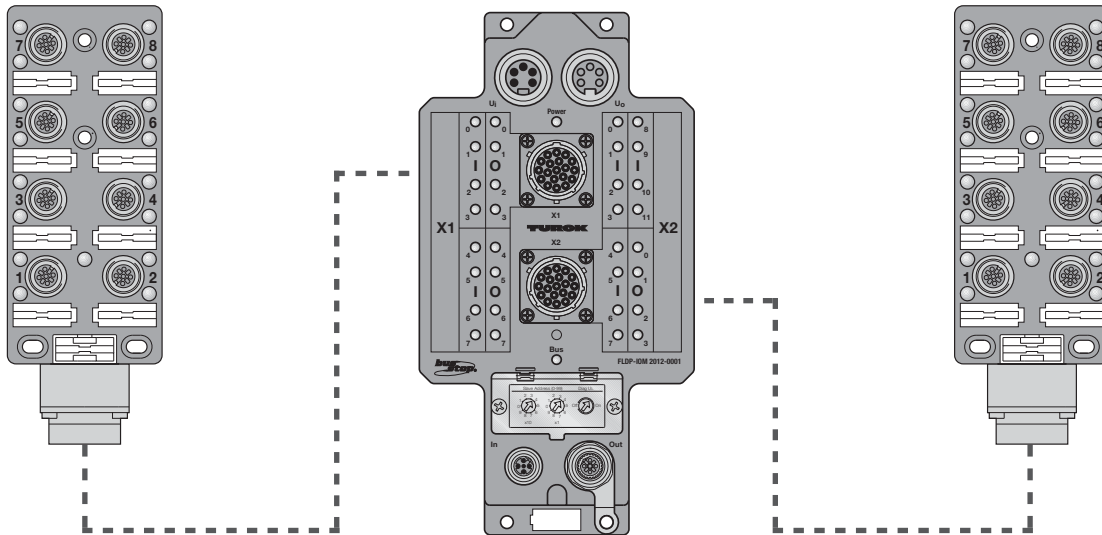

Prefabricated cable FLDP-IOM2012-0001 - 8FKS5P3: RKM23-RSM23-2M (Ident-no.: 6914321)  
 Field wireable burndy connector (female): VZ5 (Ident-no.: 8000063)  
 Field wireable burndy connector (male): VZ7 (Ident-no.: 8018763)

**Connection: input/output module FLDP-IOM2012 – junction 8FKS5P3**

Burndy	FLDP- IOM2012		8FKS5P3		Input/output bytes	
	X1	X2	X1	X2	X1	X2
A	+	+	+	+		
B	-	-	-	-		
S	I0	I0	S7/4	S7/4	I0.0	I1.0
R	I1	I1	S7/2	S7/2	I0.1	I1.1
M	I2	I2	S5/4	S5/4	I0.2	I1.2
L	I3	I3	S5/2	S5/2	I0.3	I1.3
H	I4	I4	S3/4	S3/4	I0.4	I1.4
G	I5	I5	S3/2	S3/2	I0.5	I1.5
D	I6	I6	S1/4	S1/4	I0.6	I1.6
C	I7	I7	S1/2	S1/2	I0.7	I1.7
U	O0	I8	S8/4	S8/4	O0.0	I2.0
T	O1	I9	S8/2	S8/2	O0.1	I2.1
P	O2	I10	S6/4	S6/4	O0.2	I2.2
N	O3	I11	S6/2	S6/2	O0.3	I2.3
K	O4	O0	S4/4	S4/4	O0.4	O1.0
J	O5	O1	S4/2	S4/2	O0.5	O1.1
F	O6	O2	S2/4	S2/4	O0.6	O1.2
E	O7	O3	S2/2	S2/2	O0.7	O1.3
V	PE	PE	PE	PE		

**Block diagram/Pin configuraton**  
**Passive junction module 8FKS5P3**

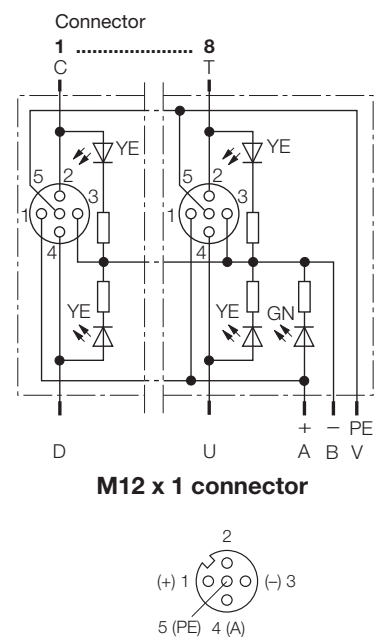

**Fieldbus I/O module PROFIBUS-DP**  
**24 digital pnp inputs**  
**8 digital outputs 0.5 A**  
**FLDP-IOM248-0001**

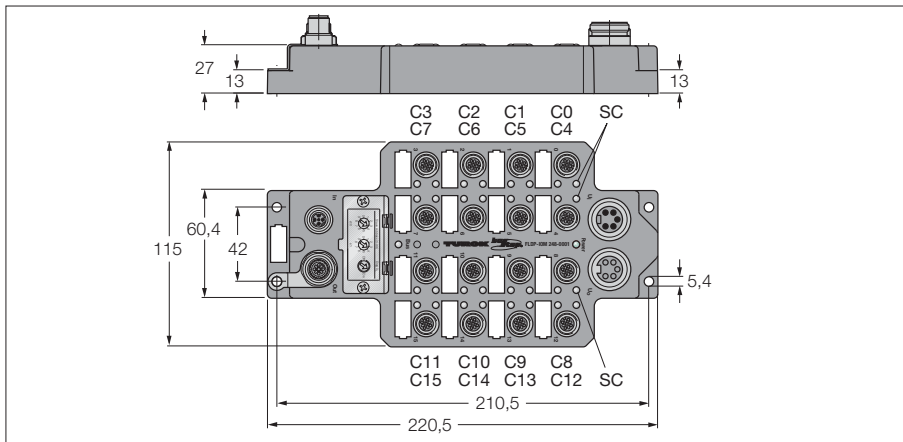

- 24 digital pnp inputs
- 8 digital outputs 0.5 A
- Module-related diagnostics
- Two channels per connector
- Fibre-glass reinforced PA6 housing
- Vibration and shock-resistant
- Encapsulated module electronics
- Metal connector
- Degree of protection IP67

<b>Type</b>	FLDP-IOM248-0001
<b>Ident-No.</b>	6825333
<b>Operating / load voltage</b>	18...30 VDC
<b>Operating current</b>	< 150 mA
<b>Fieldbus transmission rate</b>	9.6 kbps up to 12 Mbps
<b>Fieldbus addressing</b>	1...126 (decimal) via three coded rotary switches
<b>Electrical isolation</b>	to operating and load voltage
<b>Inputs</b>	
Number of channels	(24) 3-wire pnp sensors
Input voltage	18...30 VDC via operating voltage
Supply current	< 500 mA 8 channel each, short-circuit proof
Switching threshold	2 mA / 4 mA
Input delay	2.5 ms
Switching frequency	≤ 250 Hz
Max. input current	6 mA
Electrical isolation	galvanic isolation against the bus
<b>Outputs</b>	
Number of channels	(8) DC actuators
Output voltage	18...30 VDC from load voltage
Output current per channel	0.5 A, short-circuit proof
Load type	resistive, inductive, lamp load
Switching frequency	≤ 250 Hz
Simultaneity factor	1
Electrical isolation	galvanic isolation against the bus
<b>Operating temperature</b>	0 to 55 °C

**Fieldbus M12 x 1**

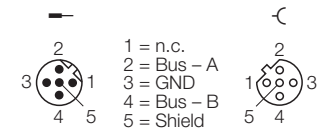

**Input M12 x 1**

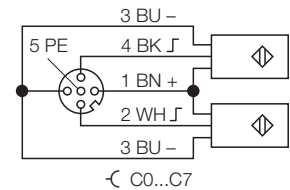

**Output M12 x 1**

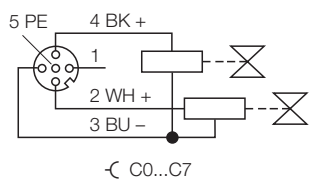

**Power supply 7/8"**

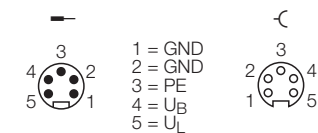

**Data in process image**

C1P4: Male Connector 1, 4-pole  
 SC: Short-circuit - group signal  
 UB: UB < 18 VDC  
 UL: UL < 18 VDC

		Bit 7	Bit 6	Bit 5	Bit 4	Bit 3	Bit 2	Bit 1	Bit 0
<b>Input</b>	<b>Byte 0</b>	C3P2	C3P4	C2P2	C2P4	C1P2	C1P4	C0P2	C0P4
	<b>Byte 1</b>	C7P2	C7P4	C6P2	C6P4	C5P2	C5P4	C4P2	C4P4
	<b>Byte 2</b>	C11P2	C11P4	C10P2	C10P4	C9P2	C9P4	C8P2	C8P4
<b>Output</b>	<b>Byte 0</b>	C15P2	C15P4	C14P2	C14P4	C13P2	C13P4	C12P2	C12P4
<b>Diagnostics</b>	<b>Byte 0</b>	-	-	-	-	-	UB	UL	SC



# Compact fieldbus I/O modules in IP67 for DeviceNet™

## Type code

**F D N P - L 0 4 0 4 G - T T**

### Device types

(F) Compact fieldbus I/O-module

### Fieldbus

(DN) DeviceNet™

### Device characteristics

(P) 8 I/O connections/load voltage/  
220 mm

(L) 8 I/O connections/ 197 mm

### I/O-Configuration

#### LX series

(L) npn/pnp, channel-specific wire-break and short-circuit monitoring

(P) npn/pnp, channel-specific wire-break and short-circuit monitoring

#### SE series

(S) pnp, common short-circuit indication of inputs,

(N) npn, common short-circuit indication

(CPG) combined input/output per connector

(XSG) configurable I/O range

### Load voltage connection

(T) 7/8"-male and female

### DeviceNet™ pin configuration:

(T) 7/8"-male and female

### Current load capacity (only outputs)

(G) outputs 0.5 A

(H) outputs 1.4 or 2.0 A

### Number of inputs/outputs

number of inputs (first two figures)

number of outputs (last two figures)



# Compact fieldbus I/O modules in IP67 for DeviceNet™

**TURCK**

Industrial  
Automation

Series FDNL



- Compact flat housing with up to 16 channels
- Module diagnostics (SE series) or channel-specific diagnostics (LX series)
- Power supply of the outputs is implemented via DeviceNet™

Series FDNP



- Compact flat housing with up to 16 channels,
- Module diagnostics (SE series) or channel-specific diagnostics (LX series)
- Separate connection to power supply

# Compact fieldbus I/O modules in IP67 for DeviceNet™

## Selection guide

		Number of inputs	Number of output	Number of inputs/outputs per connector	nprn/pnp sensor connectable	Maximum load current [A]	Supply concept of the outputs	Page
<b>LX-Serie – channel-specific diagnostics</b>	<b>Ident-no.</b>							
FDNL-L0800-T	6603335	8	–	1/–	nprn/pnp	–	–	286
FDNL-L1600-T	6602335	16	–	2/–	nprn/pnp	–	–	289
FDNP-CPG88-TT	6603324	8	8	1/1	pnp	0,5	Aux	297
FDNP-L0404G-TT	6603327	4	4	1/1	nprn/pnp	0,5	Aux	295
FDNP-L0808G-TT	6602389	8	8	2/2	nprn/pnp	0,5	Aux	298
FDNP-P1204G-TT	6602672	12	4	2/2	pnp	0,5	Aux	301
FDNP-P0808H-TT	6603329	8	8	2/2	pnp	2	Aux	299
FDNP-L0808H-TT	6603328	8	8	2/2	nprn/pnp	2	Aux	300
<b>SE-Serie – module-specific diagnostics,</b>								
FDNL-S0800-T	6603336	8	–	1/–	pnp	–	–	284
FDNL-N0800-T	6603671	8	–	1/–	nprn	–	–	285
FDNL-S1600-T	6603316	16	–	2/–	pnp	–	–	287
FDNL-N1600-T	6603672	16	–	2/–	nprn	–	–	288
FDNL-CSG88-T	6603351	8	8	1/1	pnp	0,5	Bus	290
FDNP-S0404G-TT	6603331	4	4	1/1	pnp	0,5	Aux	294
FDNP-S0808G-TT	6603348	8	8	2/2	pnp	0,5	Aux	296
FDNP-XSG16-TT	6603323	16 configurable channels			pnp	0,5	Aux	302
FDNP-S0008G-TT	6603673	–	8	–/1	–	0,5	Aux	292
FDNP-S0008H-TT	6603674	–	8	–/1	–	1,4	Aux	293

# Compact fieldbus I/O modules in IP67 for DeviceNet™

**TURCK**

Industrial  
Automation

## Series FDNL – General information



The compact FDNL series fieldbus I/O modules allow direct connection of up to 16 digital inputs/outputs to a DeviceNet™ network.

Depending on type, the I/O modules offer channel (LX series) and module (SE series) specific wire-break/short-circuit diagnostics.

The I/O modules support transmission rates of 500 Kbit/s as well as all types of DeviceNet™ communication modes, incl. "Poll", "Strobe", "Cyclic", "Change of State (COS)" and "UCMM".

The DeviceNet™ connection is implemented via 5-pole, 7/8" connectors. Both the module electronics and also the inputs and outputs are supplied via DeviceNet™. The I/O level is equipped throughout with M12 metal round connectors.

Glass-fibre reinforced plastic housings and the fully encapsulated module electronics guarantee protection degree IP67. The I/O modules are therefore particularly suited for use in harsh industrial environments.

### General technical data

#### Characteristics

- LX series: Channel-specific short-circuit and wire-break diagnostics of inputs and outputs
- SE series: Module-specific short-circuit diagnostics of inputs and outputs

#### Settings

- DeviceNet™ address: 0...63 (decimal) adjustable via two coded rotary switches
- Transmission rate: automatic

#### LEDs

- Inputs: green: ON
- Outputs: green: ON
- wire-break and short-circuit, Only LX series (dual colour LED): yellow: wire-break, red: short-circuit
- Module status (dual colour LED): green: operational, green flashing: detection of the baud rate, red flashing: I/O short-circuit
- Network status LED (dual colour LED): green: communication, green flashing: ready to establish communication; red: communication failed, red flashing: communication time-out

#### Connections

- DeviceNet™: Nickel-plated brass
- 7/8" connector, 5-pole; IN and OUT
- Inputs/outputs: female M12 x 1 connectors; 5-pole

#### Housing

- Housing: PA6-GF30, glass-fibre reinforced plastic housing with encapsulated electronics and nickel-plated brass connectors
- Mounting: via 4 through-holes, Ø 5.4mm
- Degree of protection: IP67 (NEMA 1, 3, 4, 12, 13)
- Temperature range:
  - LX series: -25 °C to +70 °C (-13 °F to 158 °F)
  - SE series: -40 °C to 70 °C (-40 °F to 158 °F)
- Dimensions: 197 x 60 x 27 mm (H x W x D)

#### Approvals



# Fieldbus I/O module for DeviceNet™

## 8 digital pnp inputs

### FDNL-S0800-T

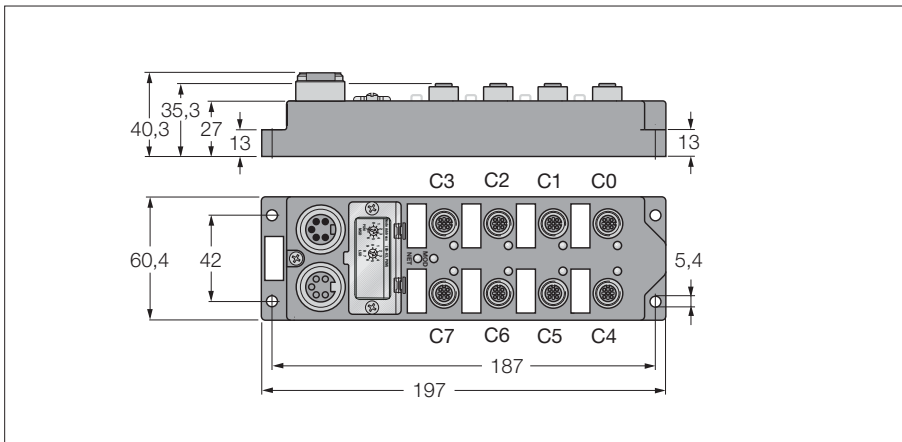

- 8 digital pnp inputs
- Short-circuit monitoring
- Module-related diagnostics
- One channel per connector
- Fibre-glass reinforced PA6 housing
- Vibration and shock-resistant
- Encapsulated module electronics
- Metal connector
- Degree of protection IP67

<b>Type</b>	FDNL-S0800-T
Ident-No.	6603336
<b>Operating / load voltage</b>	11...26 VDC
Operating current	< 50 mA
<b>Fieldbus transmission rate</b>	125 kbps to 500 kbps
Fieldbus addressing	0...63 (decimal) via coded rotary switches to operating and load voltage
Electrical isolation	
<b>Inputs</b>	
Number of channels	(8) 3-wire pnp sensors
Input voltage	13...26 VDC
Input delay	2.5 ms
Switching frequency	≤ 100 Hz
Max. input current	6 mA
Electrical isolation	galvanic isolation against the bus
<b>Sensor supply</b>	bus connection
<b>Operating temperature</b>	- 40... +70 °C

#### Fieldbus 7/8"

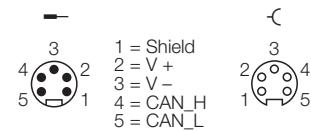

#### Input M12 x 1

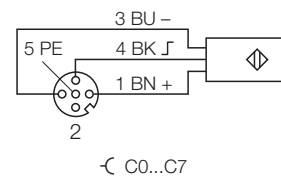

#### Data in process image

C1P4: Male Connector 1, 4-pole  
IGS: Wire-break/ short circuit - group signal

		Bit 7	Bit 6	Bit 5	Bit 4	Bit 3	Bit 2	Bit 1	Bit 0
Input	Byte 0	C7P4	C6P4	C5P4	C4P4	C3P4	C2P4	C1P4	C0P4
	Byte 1	IGS	-	-	-	-	-	-	-

**Fieldbus I/O module for DeviceNet™**  
**8 digital npn inputs**  
**FDNL-N0800-T**

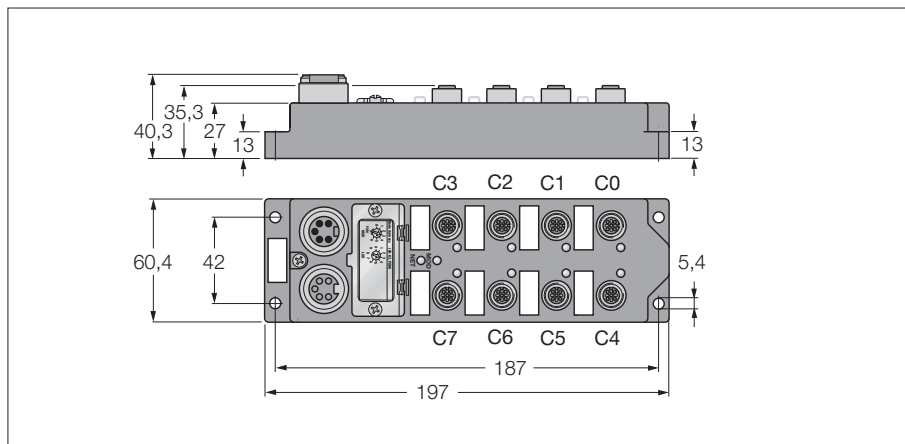

- 8 digital npn inputs
- Short-circuit monitoring
- Module-related diagnostics
- One channel per connector
- Fibre-glass reinforced PA6 housing
- Vibration and shock-resistant
- Encapsulated module electronics
- Metal connector
- Degree of protection IP67

<b>Type</b>	FDNL-N0800-T
Ident-No.	6603671
<b>Operating / load voltage</b>	11...26 VDC
Operating current	< 50 mA
<b>Fieldbus transmission rate</b>	125 kbps to 500 kbps
Fieldbus addressing	0...63 (decimal) via coded rotary switches
Electrical isolation	to operating and load voltage
<b>Inputs</b>	
Number of channels	(8) 3-wire npn sensors
Input voltage	13...26 VDC
Input delay	2.5 ms
Switching frequency	≤ 100 Hz
Max. input current	6 mA
Electrical isolation	galvanic isolation against the bus
<b>Sensor supply</b>	bus connection
<b>Operating temperature</b>	- 40... +70 °C

**Fieldbus 7/8"**

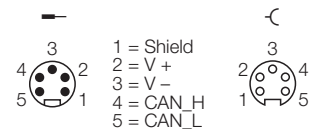

**Input M12 x 1**

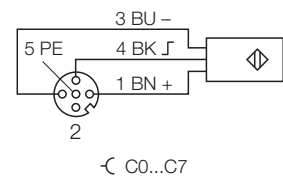

**Data in process image**

C1P4: Male Connector 1, 4-pole  
 IGS: Wire-break/ short circuit - group signal

		Bit 7	Bit 6	Bit 5	Bit 4	Bit 3	Bit 2	Bit 1	Bit 0
Input	Byte 0	C7P4	C6P4	C5P4	C4P4	C3P4	C2P4	C1P4	C0P4
	Byte 1	IGS	-	-	-	-	-	-	-

# Fieldbus I/O module for DeviceNet™

## 8 digital npn/pnp inputs

### FDNL-L0800-T

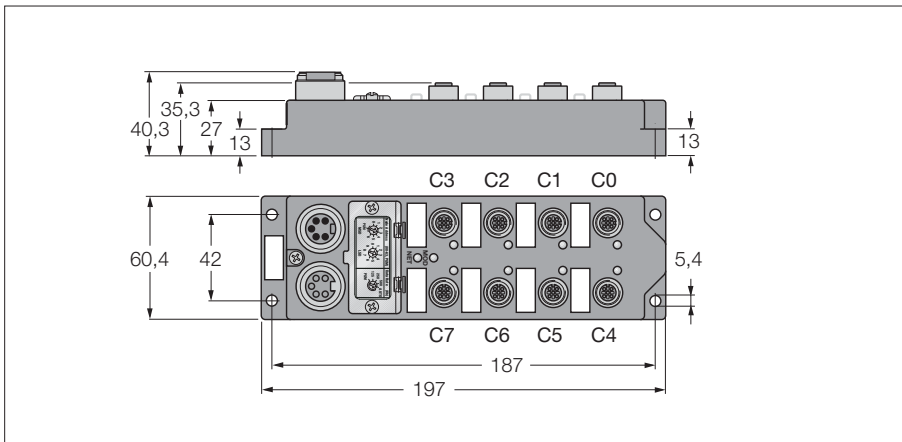

- 8 digital npn/pnp inputs
- Wire-break monitoring
- Channel-related diagnostics
- One channel per connector
- Fibre-glass reinforced PA6 housing
- Vibration and shock-resistant
- Encapsulated module electronics
- Metal connector
- Degree of protection IP67

<b>Type</b>	FDNL-L0800-T
Ident-No.	6603335
<b>Operating / load voltage</b>	11...26 VDC
Operating current	< 100 mA
<b>Fieldbus transmission rate</b>	125 kbps to 500 kbps
Fieldbus addressing	0...63 (decimal) via coded rotary switches to operating and load voltage
Electrical isolation	
<b>Inputs</b>	
Number of channels	(8) 3-wire npn/pnp sensors
Input voltage	13...26 VDC
Input delay	2.5 ms
Switching frequency	≤ 100 Hz
Max. input current	6 mA
Electrical isolation	galvanic isolation against the bus
<b>Sensor supply</b>	bus connection
<b>Operating temperature</b>	-25 to 70 °C

#### Fieldbus 7/8"

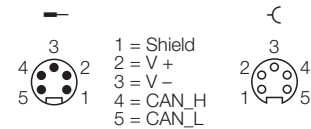

#### Input M12 x 1

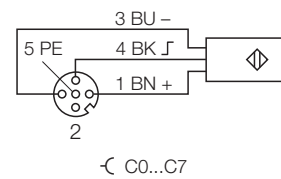

#### Data in process image

C1P4: Male Connector 1, 4-pole

ISS-3: Short-circuit channel 3

IOS-2: Wire-break channel 2

		Bit 7	Bit 6	Bit 5	Bit 4	Bit 3	Bit 2	Bit 1	Bit 0
Input	Byte 0	C7P4	C6P4	C5P4	C4P4	C3P4	C2P4	C1P4	C0P4
	Byte 1	ISS-7	ISS-6	ISS-5	ISS-4	ISS-3	ISS-2	ISS-1	ISS-0
	Byte 2	IOS-7	IOS-6	IOS-5	IOS-4	IOS-3	IOS-2	IOS-1	IOS-0

**Fieldbus I/O module for DeviceNet™**  
**16 digital pnp inputs**  
**FDNL-S1600-T**

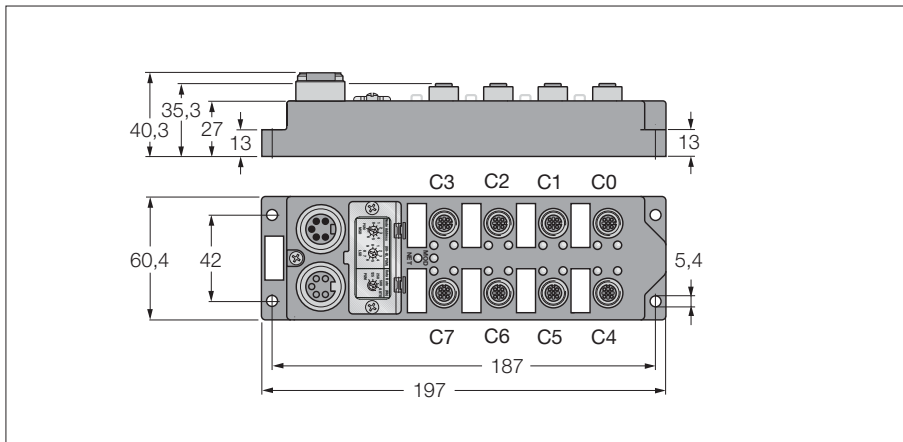

- 16 digital pnp inputs
- Short-circuit monitoring
- Module-related diagnostics
- Two channels per connector
- Fibre-glass reinforced PA6 housing
- Vibration and shock-resistant
- Encapsulated module electronics
- Metal connector
- Degree of protection IP67

<b>Type</b>	FDNL-S1600-T
Ident-No.	6603316
<b>Operating / load voltage</b>	11...26 VDC
Operating current	< 50 mA
<b>Fieldbus transmission rate</b>	125 kbps to 500 kbps
Fieldbus addressing	0...63 (decimal) via coded rotary switches to operating and load voltage
Electrical isolation	
<b>Inputs</b>	
Number of channels	(16) 3-wire pnp sensors
Input voltage	13...26 VDC
Input delay	2.5 ms
Switching frequency	≤ 100 Hz
Max. input current	6 mA
Electrical isolation	galvanic isolation against the bus
<b>Sensor supply</b>	bus connection
<b>Operating temperature</b>	- 40... +70 °C

**Fieldbus 7/8"**

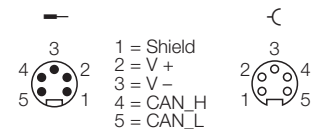

**Input M12 x 1**

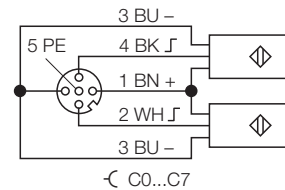

**Data in process image**

C1P4: Male Connector 1, 4-pole  
 IGS: Wire-break/ short circuit - group signal

		Bit 7	Bit 6	Bit 5	Bit 4	Bit 3	Bit 2	Bit 1	Bit 0
Input	Byte 0	C3P2	C3P4	C2P2	C2P4	C1P2	C1P4	C0P2	C0P4
	Byte 1	C7P2	C7P4	C6P2	C6P4	C5P2	C5P4	C4P2	C4P4
	Byte 2	IGS	-	-	-	-	-	-	-

# Fieldbus I/O module for DeviceNet™

## 16 digital npn inputs

### FDNL-N1600-T

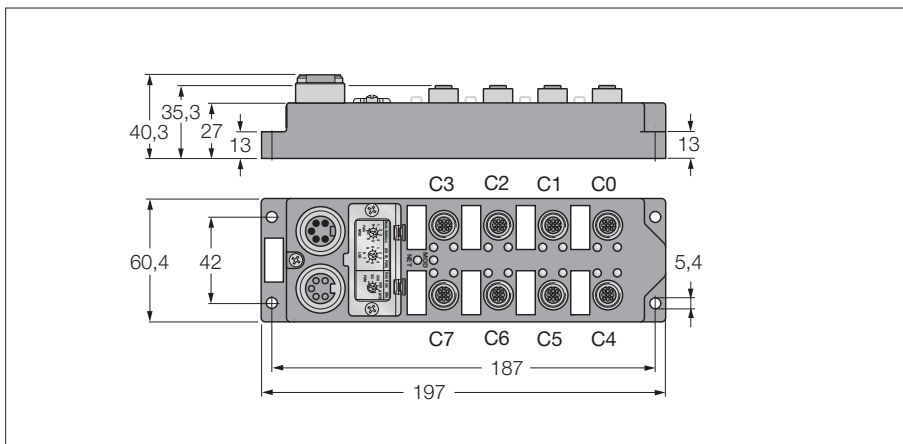

- 16 digital npn inputs
- Short-circuit monitoring
- Module-related diagnostics
- Two channels per connector
- Fibre-glass reinforced PA6 housing
- Vibration and shock-resistant
- Encapsulated module electronics
- Metal connector
- Degree of protection IP67

<b>Type</b>	FDNL-N1600-T
Ident-No.	6603672
<b>Operating / load voltage</b>	11...26 VDC
Operating current	< 50 mA
<b>Fieldbus transmission rate</b>	125 kbps to 500 kbps
Fieldbus addressing	0...63 (decimal) via coded rotary switches to operating and load voltage
Electrical isolation	
<b>Inputs</b>	
Number of channels	(16) 3-wire npn sensors
Input voltage	13...26 VDC
Input delay	2.5 ms
Switching frequency	≤ 100 Hz
Max. input current	6 mA
Electrical isolation	galvanic isolation against the bus
<b>Sensor supply</b>	bus connection
<b>Operating temperature</b>	- 40... +70 °C

#### Fieldbus 7/8"

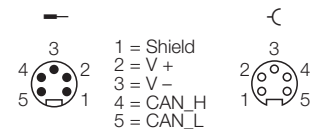

#### Input M12 x 1

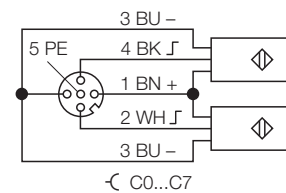

#### Data in process image

C1P4: Male Connector 1, 4-pole  
IGS: Wire-break/ short circuit - group signal

		Bit 7	Bit 6	Bit 5	Bit 4	Bit 3	Bit 2	Bit 1	Bit 0
Input	Byte 0	C3P2	C3P4	C2P2	C2P4	C1P2	C1P4	C0P2	C0P4
	Byte 1	C7P2	C7P4	C6P2	C6P4	C5P2	C5P4	C4P2	C4P4
	Byte 2	IGS	-	-	-	-	-	-	-



**Fieldbus I/O module for DeviceNet™**  
**16 digital pnp/npn inputs**  
**FDNL-L1600-T**

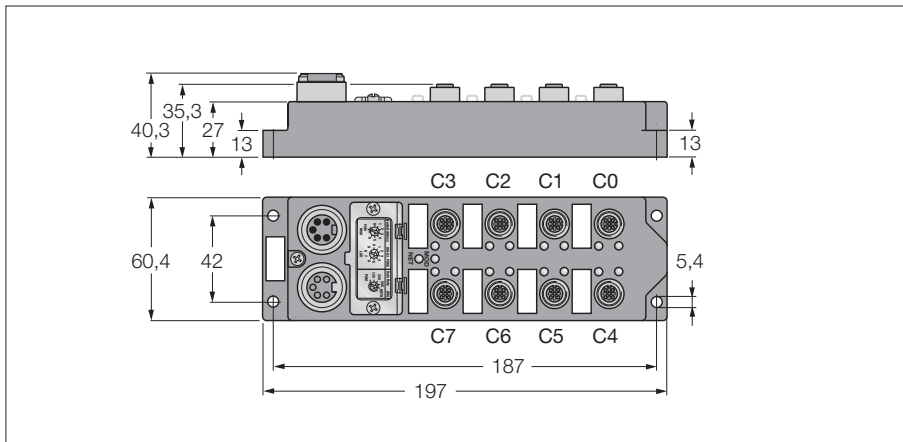

- 16 digital npn/pnp inputs
- Wire-break monitoring
- Channel-related diagnostics
- Two channels per connector
- Fibre-glass reinforced PA6 housing
- Vibration and shock-resistant
- Encapsulated module electronics
- Metal connector
- Degree of protection IP67

<b>Type</b>	FDNL-L1600-T
Ident-No.	6602335
<b>Operating / load voltage</b>	11...26 VDC
Operating current	< 140 mA
<b>Fieldbus transmission rate</b>	125 kbps to 500 kbps
Fieldbus addressing	0...63 (decimal) via coded rotary switches to operating and load voltage
Electrical isolation	
<b>Inputs</b>	
Number of channels	(16) 3-wire npn/pnp sensors
Input voltage	13...26 VDC
Input delay	2.5 ms
Switching frequency	≤ 100 Hz
Max. input current	6 mA
Electrical isolation	galvanic isolation against the bus
<b>Sensor supply</b>	bus connection
<b>Operating temperature</b>	- 25... +70 °C

**Fieldbus 7/8"**

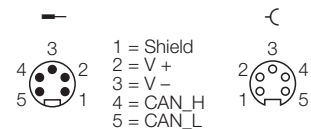

**Input M12 x 1**

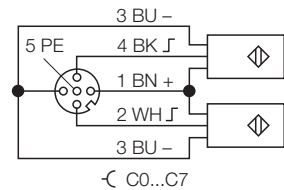

**Data in process image**

C1P4: Male Connector 1, 4-pole  
 ISS-3: Short-circuit channel 3  
 IOS-2: Wire-break channel 2

		Bit 7	Bit 6	Bit 5	Bit 4	Bit 3	Bit 2	Bit 1	Bit 0
Input	<b>Byte 0</b>	C3P2	C3P4	C2P2	C2P4	C1P2	C1P4	C0P2	C0P4
	<b>Byte 1</b>	C7P2	C7P4	C6P2	C6P4	C5P2	C5P4	C4P2	C4P4
	<b>Byte 2</b>	ISS-7	ISS-6	ISS-5	ISS-4	ISS-3	ISS-2	ISS-1	ISS-0
	<b>Byte 3</b>	ISS-15	ISS-14	ISS-13	ISS-12	ISS-11	ISS-10	ISS-9	ISS-8
	<b>Byte 4</b>	IOS-7	IOS-6	IOS-5	IOS-4	IOS-3	IOS-2	IOS-1	IOS-0
	<b>Byte 5</b>	IOS-15	IOS-14	IOS-13	IOS-12	IOS-11	IOS-10	IOS-9	IOS-8

# Fieldbus I/O module for DeviceNet™

## 8 digital pnp inputs

## 8 digital outputs 0.5 A

### FDNL-CSG88-T

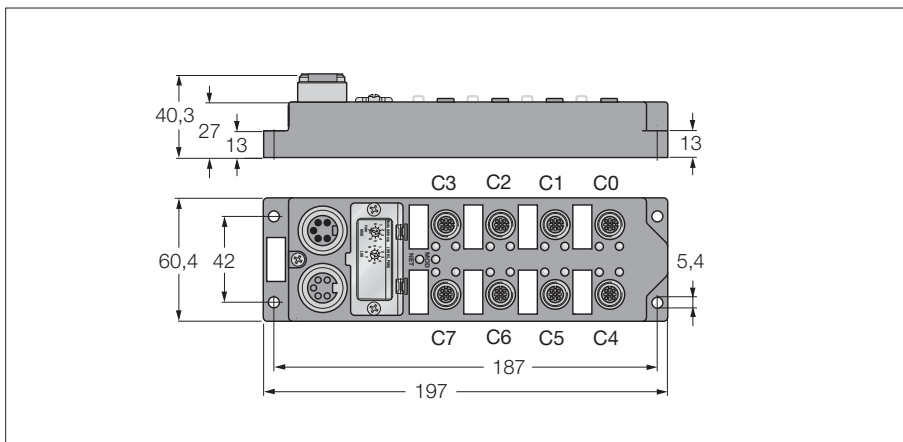

- 8 digital pnp inputs
- 8 digital outputs 0.5 A
- Short-circuit monitoring
- Module-related diagnostics
- Two channels per connector
- Separate auxiliary / load voltage (Aux)
- Fibre-glass reinforced PA6 housing
- Vibration and shock-resistant
- Encapsulated module electronics
- Metal connector
- Degree of protection IP67

<b>Type</b>	FDNL-CSG88-T
Ident-No.	6603351
<b>Operating / load voltage</b>	11...26 VDC
Operating current	< 100 mA
<b>Fieldbus transmission rate</b>	125 kbps to 500 kbps
Fieldbus addressing	0...63 (decimal) via coded rotary switches
Electrical isolation	to operating and load voltage
<b>Inputs</b>	
Number of channels	(8) 3-wire pnp sensors
Input voltage	13...26 VDC
Input delay	2.5 ms
Switching frequency	≤ 100 Hz
Max. input current	6 mA
Electrical isolation	galvanic isolation against the bus
<b>Outputs</b>	
Number of channels	(8) DC actuators
Output voltage	24 VDC
Output current per channel	0.5 A, short-circuit proof
Load type	resistive, inductive, lamp load
Switching frequency	≤ 100 Hz
Simultaneity factor	1
Electrical isolation	galvanic isolation against the bus
<b>Sensor supply</b>	bus connection
Actuator power supply	bus connection
<b>Operating temperature</b>	- 40... +70 °C

#### Fieldbus 7/8"

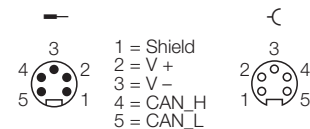

#### Input M12 x 1

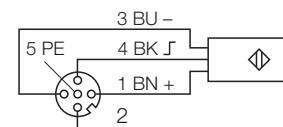

↺ C0...C7

#### Output M12 x 1

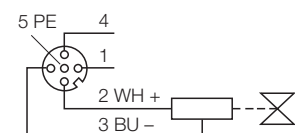

↺ C0...C7

#### Data in process image

C1P4: Male Connector 1, 4-pole  
 IGS: Wire-break/ short circuit - group signal  
 OGS: Short-circuit - group signal

		Bit 7	Bit 6	Bit 5	Bit 4	Bit 3	Bit 2	Bit 1	Bit 0
Input	Byte 0	C7P4	C6P4	C5P4	C4P4	C3P4	C2P4	C1P4	C0P4
	Byte 1	IGS	OGS	-	-	-	-	-	-
Output	Byte 0	C7P2	C6P2	C5P2	C4P2	C3P2	C2P2	C1P2	C0P2

# Compact fieldbus I/O modules in IP67 for DeviceNet™

**TURCK**

Industrial  
Automation

## Series FDNP – general information



The compact FDNP series fieldbus I/O modules allow direct connection of up to 16 digital inputs/outputs to a DeviceNet™ network.

Depending on type, the I/O modules offer channel (LX series) and module (SE series) specific wire-break/short-circuit diagnostics.

The I/O modules support transmission rates of 500 Kbit/s as well as all types of DeviceNet™ communication modes, incl. "Poll", "Strobe", "Cyclic", "Change of State (COS)" and "UCMM".

The DeviceNet™ connection is implemented via 5-pole, 7/8" round connectors. The module electronics and the inputs are supplied via DeviceNet™; the auxiliary voltage for the outputs is also fed via a 7/8" round connector and can be fed through via a second 7/8" round connector. The I/O level is equipped throughout with metal M12 connectors.

Glass-fibre reinforced plastic housings and the fully encapsulated module electronics guarantee protection degree IP67. The I/O modules are therefore particularly suited for use in harsh industrial environments.

### General technical data

#### Characteristics

- LX series: Channel-specific short-circuit and wire-break diagnostics of inputs and outputs
- SE series: Module-specific short-circuit diagnostics of inputs and outputs

#### Settings

- DeviceNet™ address: 0...63 (decimal) adjustable via two coded rotary switches
- Transmission rate: automatic

#### LEDs

- Inputs: green: ON
- Outputs: green: ON
- wire-break and short-circuit, Only LX series (dual colour LED): yellow: wire-break, red: short-circuit
- Module status (dual colour LED): green: operational, green flashing: detection of the baud rate, red flashing: I/O short-circuit
- Network status LED (dual colour LED): green: communication, green flashing: ready to establish communication; red: communication failed, red flashing: communication time-out

#### Connections

- DeviceNet™: nickel-plated brass; 7/8" connector, 5-pole; IN and OUT
- aux power: 7/8" connector, 4-pole; IN and OUT
- Inputs/outputs: female M12 x 1 connectors; 5-pole

#### Housing

- Housing: PA6-GF30, glass-fibre reinforced plastic housing with encapsulated electronics and nickel-plated brass connectors
- Mounting: via 4 through-holes, Ø 5.4mm
- Degree of protection: IP67 (NEMA 1, 3, 4, 12, 13)
- Temperature range:
  - LX series: -25 °C to +70 °C (-13 °F to 158 °F)
  - SE series: -40 °C to 70 °C (-40 °F to 158 °F)
- Dimensions: 220 x 60 x 27 mm (H x W x D)

#### Approvals



**Fieldbus I/O module for DeviceNet™**  
**8 digital outputs 0.5 A**  
**FDNP-S0008G-TT**

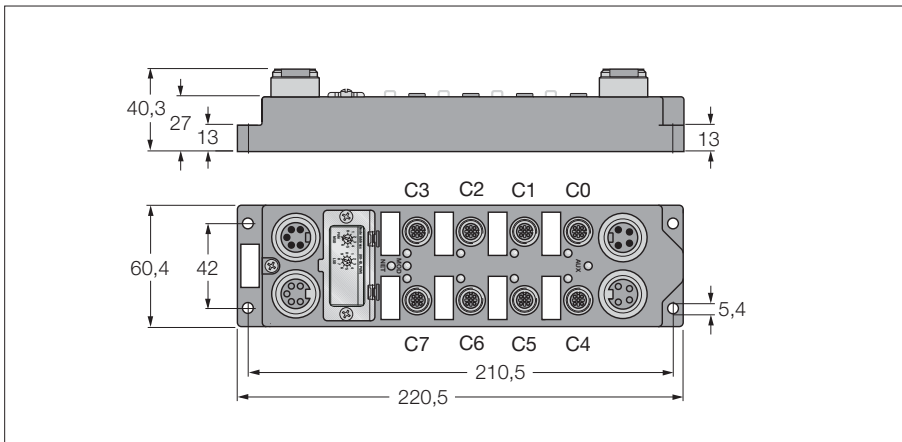

- 8 digital outputs 0.5 A
- Output diagnostics per channel
- One channel per connector
- Separate actuator power supply
- Fibre-glass reinforced PA6 housing
- Vibration and shock-resistant
- Encapsulated module electronics
- Metal connector
- Degree of protection IP67

<b>Type</b>	FDNP-S0008G-TT
Ident-No.	6603673
<b>Operating / load voltage</b>	11...26 VDC
Operating current	< 140 mA
<b>Fieldbus transmission rate</b>	125 kbps to 500 kbps
Fieldbus addressing	0...63 (decimal) via coded rotary switches to operating and load voltage
Electrical isolation	
<b>Outputs</b>	
Number of channels	(8) DC actuators
Output voltage	24 VDC
Output current per channel	0.5 A, short-circuit proof
Load type	resistive, inductive, lamp load
Switching frequency	≤ 100 Hz
Simultaneity factor	1
Electrical isolation	galvanic isolation against the bus
<b>Sensor supply</b>	bus connection
Actuator power supply	separate (Aux)
<b>Operating temperature</b>	- 40... +70 °C

**Fieldbus 7/8"**

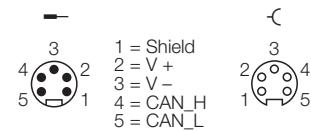

**Output M12 x 1**

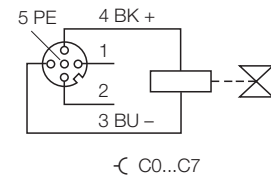

**Power supply 7/8"**

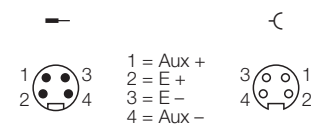

**Data in process image**

C1P4: Male Connector 1, 4-pole

OGS: Short-circuit - group signal

		Bit 7	Bit 6	Bit 5	Bit 4	Bit 3	Bit 2	Bit 1	Bit 0
<b>Output</b>	<b>Byte 0</b>	C7P4	C6P4	C5P4	C4P4	C3P4	C2P4	C1P4	C0P4
<b>Input</b>	<b>Byte 0</b>	OS-7	OS-6	OS-5	OS-4	OS-3	OS-2	OS-1	OS-0

**Fieldbus I/O module for DeviceNet™**  
**8 digital outputs 1.4 A**  
**FDNP-S0008H-TT**

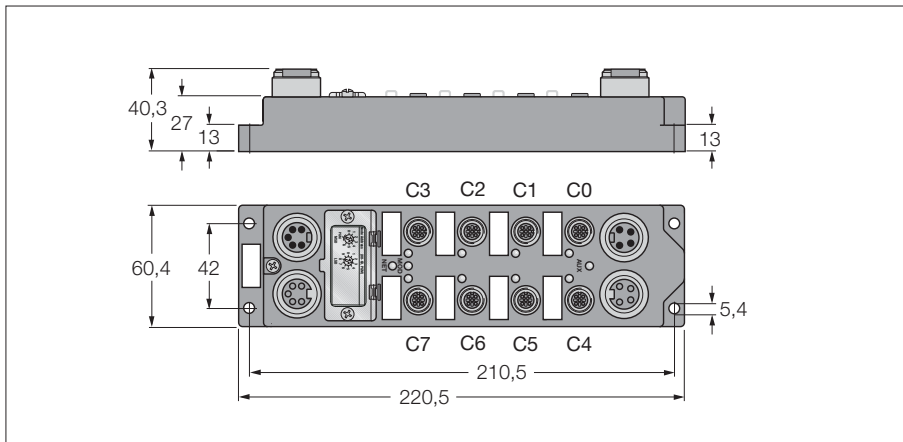

- 8 digital outputs 1.4 A
- Output diagnostics per channel
- One channel per connector
- Separate actuator power supply
- Fibre-glass reinforced PA6 housing
- Vibration and shock-resistant
- Encapsulated module electronics
- Metal connector
- Degree of protection IP67

<b>Type</b>	FDNP-S0008H-TT
Ident-No.	6603674
<b>Operating / load voltage</b>	11...26 VDC
Operating current	< 50 mA
<b>Fieldbus transmission rate</b>	125 kbps to 500 kbps
Fieldbus addressing	0...63 (decimal) via coded rotary switches to operating and load voltage
Electrical isolation	
<b>Outputs</b>	
Number of channels	(8) DC actuators
Output voltage	24 VDC
Output current per channel	1.4 A, short-circuit proof
Load type	resistive, inductive, lamp load
Switching frequency	≤ 100 Hz
Simultaneity factor	0.8
Electrical isolation	galvanic isolation against the bus
<b>Sensor supply</b>	bus connection
Actuator power supply	separate (Aux)
<b>Operating temperature</b>	- 40... +70 °C

**Fieldbus 7/8"**

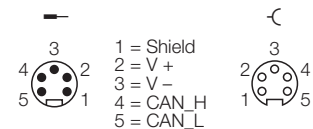

**Output M12 x 1**

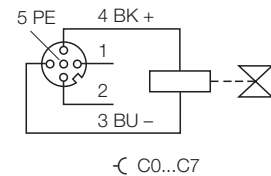

**Power supply 7/8"**

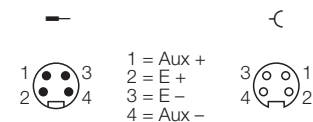

**Data in process image**

C1P4: Male Connector 1, 4-pole  
 OGS: Short-circuit - group signal

		Bit 7	Bit 6	Bit 5	Bit 4	Bit 3	Bit 2	Bit 1	Bit 0
<b>Output</b>	<b>Byte 0</b>	C7P4	C6P4	C5P4	C4P4	C3P4	C2P4	C1P4	C0P4
<b>Input</b>	<b>Byte 0</b>	OS-7	OS-6	OS-5	OS-4	OS-3	OS-2	OS-1	OS-0



**Fieldbus I/O module for DeviceNet™**  
**4 digital pnp inputs**  
**4 digital outputs 0.5 A**  
**FDNP-S0404G-TT**

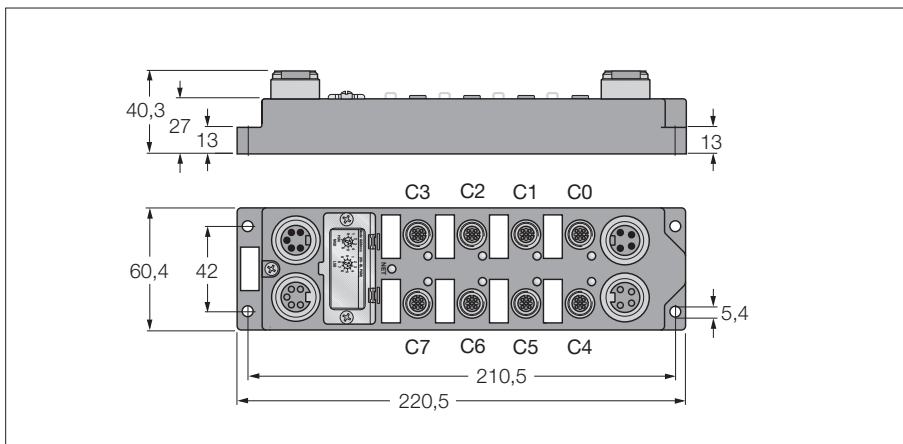

- 4 digital pnp inputs
- 4 digital outputs 0.5 A
- Short-circuit monitoring
- Module-related diagnostics
- One channel per connector
- Separate actuator power supply
- Fibre-glass reinforced PA6 housing
- Vibration and shock-resistant
- Encapsulated module electronics
- Metal connector
- Degree of protection IP67

<b>Type</b>	FDNP-S0404G-TT
Ident-No.	6603331
<b>Operating / load voltage</b>	11...26 VDC
Operating current	< 75 mA
<b>Fieldbus transmission rate</b>	125 kbps to 500 kbps
Fieldbus addressing	0...63 (decimal) via coded rotary switches to operating and load voltage
Electrical isolation	
<b>Inputs</b>	
Number of channels	(4) 3-wire pnp sensors
Input voltage	13...26 VDC
Input delay	2.5 ms
Switching frequency	≤ 100 Hz
Max. input current	6 mA
Electrical isolation	galvanic isolation against the bus
<b>Outputs</b>	
Number of channels	(4) DC actuators
Output voltage	24 VDC
Output current per channel	0.5 A, short-circuit proof
Load type	resistive, inductive, lamp load
Switching frequency	≤ 100 Hz
Simultaneity factor	1
Electrical isolation	galvanic isolation against the bus
<b>Sensor supply</b>	bus connection
Actuator power supply	separate (Aux)
<b>Operating temperature</b>	- 40... +70 °C

**Fieldbus 7/8"**

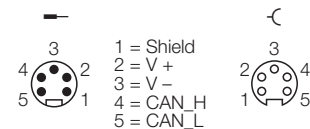

**Input M12 x 1**

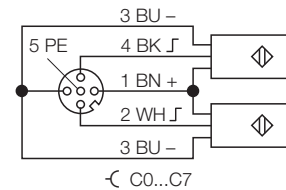

**Output M12 x 1**

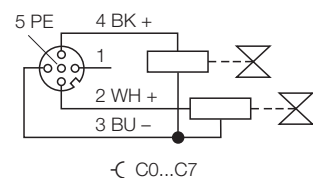

**Power supply 7/8"**

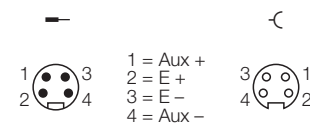

**Data in process image**

C1P4: Male Connector 1, 4-pole  
 IGS: Wire-break/ short circuit - group signal  
 OGS: Short-circuit - group signal

		Bit 7	Bit 6	Bit 5	Bit 4	Bit 3	Bit 2	Bit 1	Bit 0
<b>Input</b>	<b>Byte 0</b>	IGS	OGS	-	-	C3P4	C2P4	C1P4	C0P4
<b>Output</b>	<b>Byte 0</b>	-	-	-	-	C7P4	C6P4	C5P4	C4P4

**Fieldbus I/O module for DeviceNet™**  
**4 digital pnp/npn inputs**  
**4 digital outputs 0.5 A**  
**FDNP-L0404G-TT**

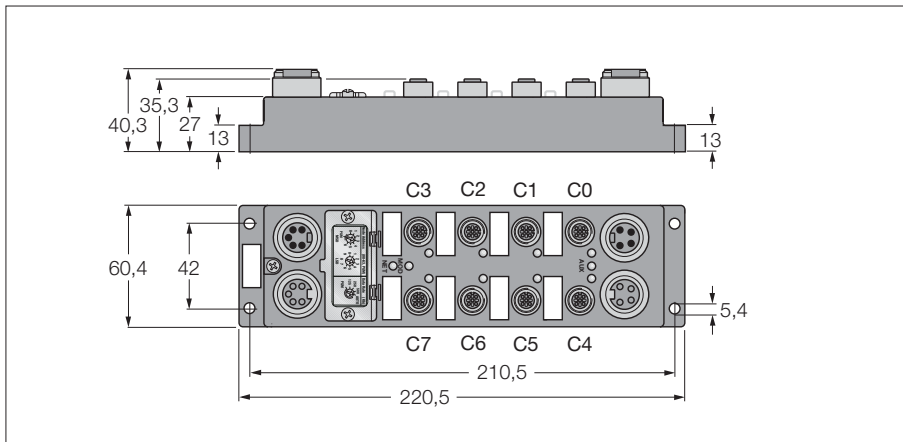

- 4 digital npn/pnp inputs and 4 digital outputs, 24 VDC 0.5 A
- Wire-break monitoring
- Short-circuit monitoring
- Channel-related diagnostics
- One channel per connector
- Separate actuator power supply
- Fibre-glass reinforced PA6 housing
- Vibration and shock-resistant
- Encapsulated module electronics
- Metal connector
- Degree of protection IP67

<b>Type</b>	FDNP-L0404G-TT
Ident-No.	6603327
<b>Operating / load voltage</b>	11...26 VDC
Operating current	< 140 mA
<b>Fieldbus transmission rate</b>	125 kbps to 500 kbps
Fieldbus addressing	0...63 (decimal) via coded rotary switches to operating and load voltage
Electrical isolation	
<b>Inputs</b>	
Number of channels	(4) 3-wire npn/pnp sensors
Input voltage	13...26 VDC
Input delay	2.5 ms
Switching frequency	≤ 100 Hz
Max. input current	6 mA
Electrical isolation	galvanic isolation against the bus
<b>Outputs</b>	
Number of channels	(4) DC actuators
Output voltage	24 VDC
Output current per channel	0.5 A, short-circuit proof
Load type	resistive, inductive, lamp load
Switching frequency	≤ 100 Hz
Simultaneity factor	1
Electrical isolation	galvanic isolation against the bus
<b>Sensor supply</b>	bus connection
Actuator power supply	separate (Aux)
<b>Operating temperature</b>	- 25... +70 °C

**Fieldbus 7/8"**

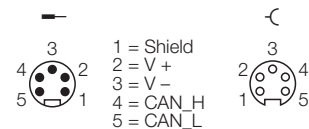

**Input M12 x 1**

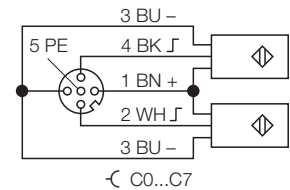

**Output M12 x 1**

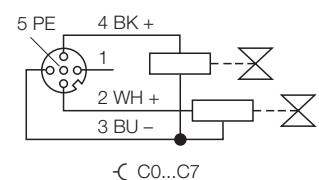

**Power supply 7/8"**

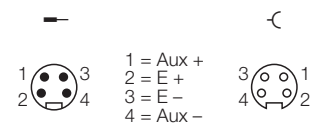

**Data in process image**

C1P4: Male Connector 1, 4-pole  
 APS: Auxiliary Status  
 ISS-3: Short-circuit channel 3  
 IOS-2: Wire-break channel 2  
 OS: Output status

		Bit 7	Bit 6	Bit 5	Bit 4	Bit 3	Bit 2	Bit 1	Bit 0
<b>Input</b>	<b>Byte 0</b>	-	-	-	-	C3P4	C2P4	C1P4	C0P4
	<b>Byte 1</b>	IOS-3	IOS-2	IOS-1	IOS-0	ISS-3	ISS-2	ISS-1	ISS-0
	<b>Byte 2</b>	OOS-3	OOS-2	OOS-1	OOS-0	OSS-3	OSS-2	OSS-1	OSS-0
	<b>Byte 3</b>	-	APS	-	-	-	-	-	-
<b>Output</b>	<b>Byte 0</b>	-	-	-	-	C7P4	C4P4	C5P4	C4P4

**Fieldbus I/O module for DeviceNet™**  
**8 digital pnp inputs**  
**8 digital outputs 0.5 A**  
**FDNP-S0808G-TT**

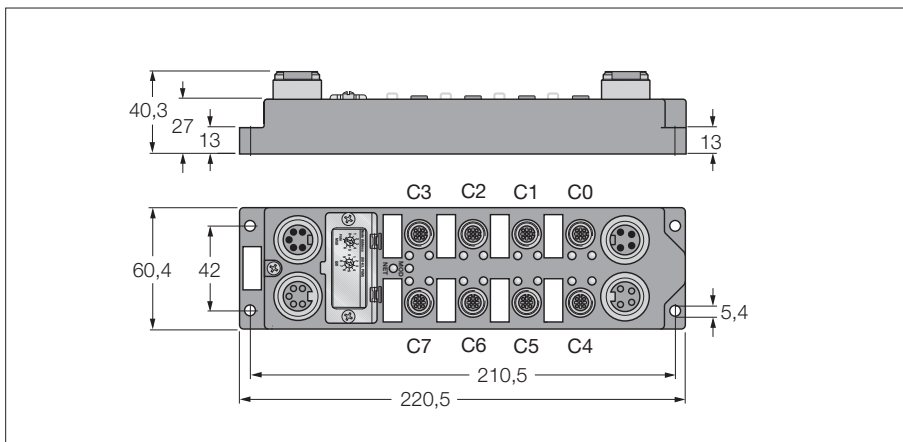

- 8 digital pnp inputs
- 8 digital outputs 0.5 A
- Short-circuit monitoring
- Module-related diagnostics
- Two channel per connector
- Separate actuator power supply
- Fibre-glass reinforced PA6 housing
- Vibration and shock-resistant
- Encapsulated module electronics
- Metal connector
- Degree of protection IP67

<b>Type</b>	FDNP-S0808G-TT
Ident-No.	6603348
<b>Operating / load voltage</b>	11...26 VDC
Operating current	< 75 mA
<b>Fieldbus transmission rate</b>	125 kbps to 500 kbps
Fieldbus addressing	0...63 (decimal) via coded rotary switches to operating and load voltage
Electrical isolation	
<b>Inputs</b>	
Number of channels	(8) 3-wire pnp sensors
Input voltage	13...26 VDC
Input delay	2.5 ms
Switching frequency	≤ 100 Hz
Max. input current	6 mA
Electrical isolation	galvanic isolation against the bus
<b>Outputs</b>	
Number of channels	(8) DC actuators
Output voltage	24 VDC
Output current per channel	0.5 A, short-circuit proof
Load type	resistive, inductive, lamp load
Switching frequency	≤ 100 Hz
Simultaneity factor	1
Electrical isolation	galvanic isolation against the bus
<b>Sensor supply</b>	bus connection
Actuator power supply	separate (Aux)
<b>Operating temperature</b>	- 40... +70 °C

**Fieldbus 7/8"**

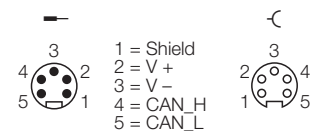

**Input M12 x 1**

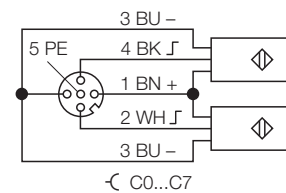

**Output M12 x 1**

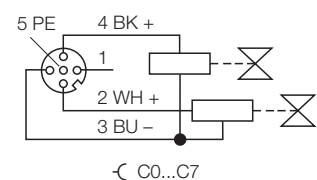

**Power supply 7/8"**

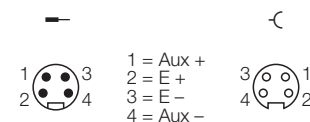

**Data in process image**

C1P4: Male Connector 1, 4-pole  
 IGS: Wire-break/ short circuit - group signal  
 OGS: Short-circuit - group signal

		Bit 7	Bit 6	Bit 5	Bit 4	Bit 3	Bit 2	Bit 1	Bit 0
<b>Input</b>	<b>Byte 0</b>	C3P2	C3P4	C2P2	C2P4	C1P2	C1P4	C0P2	C0P4
	<b>Byte 1</b>	IGS	OGS	-	-	-	-	-	-
<b>Output</b>	<b>Byte 0</b>	C7P2	C7P4	C6P2	C6P4	C5P2	C5P4	C4P2	C4P4



**Fieldbus I/O module for DeviceNet™**  
**8 digital pnp inputs**  
**8 digital outputs 0.5 A**  
**FDNP-CPG88-TT**

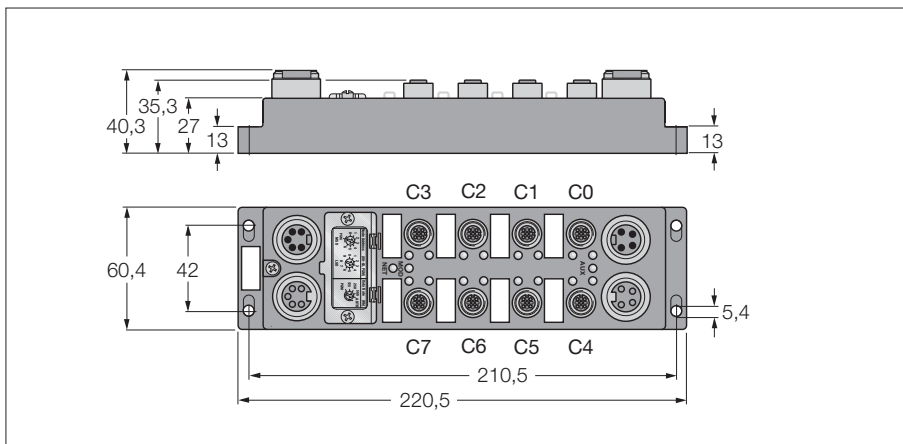

<b>Type</b>	FDNP-CPG88-TT
Ident-No.	6603324
<b>Operating / load voltage</b>	11...26 VDC
Operating current	< 100 mA
<b>Fieldbus transmission rate</b>	125 kbps to 500 kbps
Fieldbus addressing	0...63 (decimal) via coded rotary switches to operating and load voltage
Electrical isolation	
<b>Inputs</b>	
Number of channels	(8) 3-wire pnp sensors
Input voltage	13...26 VDC
Input delay	2.5 ms
Switching frequency	≤ 100 Hz
Max. input current	6 mA
Electrical isolation	galvanic isolation against the bus
<b>Outputs</b>	
Number of channels	(8) DC actuators
Output voltage	24 VDC
Output current per channel	0.5 A, short-circuit proof
Load type	resistive, inductive, lamp load
Switching frequency	≤ 100 Hz
Simultaneity factor	1
Electrical isolation	galvanic isolation against the bus
<b>Sensor supply</b>	bus connection
Actuator power supply	separate (Aux)
<b>Operating temperature</b>	- 25... +70 °C

- 8 digital pnp inputs
- and 8 digital outputs, 24 VDC 0.5 A
- Wire-break monitoring
- Short-circuit monitoring
- Channel-related diagnostics
- Two channels per connector
- Separate actuator power supply
- Fibre-glass reinforced PA6 housing
- Vibration and shock-resistant
- Encapsulated module electronics
- Metal connector
- Degree of protection IP67

**Fieldbus 7/8"**

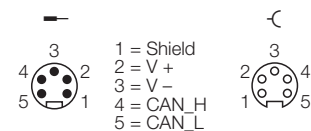

**Input M12 x 1**

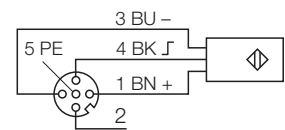

⌋ C0...C7

**Output M12 x 1**

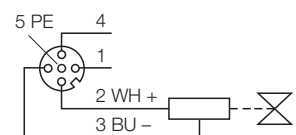

⌋ C0...C7

**Power supply 7/8"**

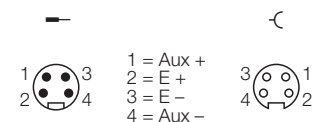

**Data in process image**

C1P4: Male Connector 1, 4-pole  
 APS: Auxiliary Status  
 ISS-3: Short-circuit channel 3  
 IOS-2: Wire-break channel 2  
 OS: Output status

		Bit 7	Bit 6	Bit 5	Bit 4	Bit 3	Bit 2	Bit 1	Bit 0
<b>Input</b>	<b>Byte 0</b>	C7P4	C6P4	C5P4	C4P4	C3P4	C2P4	C1P4	C0P4
	<b>Byte 1</b>	ISS-7	ISS-6	ISS-5	ISS-4	ISS-3	ISS-2	ISS-1	ISS-0
	<b>Byte 2</b>	IOS-7	IOS-6	IOS-5	IOS-4	IOS-3	IOS-2	IOS-1	IOS-0
	<b>Byte 3</b>	OS-7	OS-6	OS-5	OS-4	OS-3	OS-2	OS-1	OS-0
	<b>Byte 4</b>	-	APS	-	-	-	-	-	-
<b>Output</b>	<b>Byte 0</b>	C7P2	C6P2	C5P2	C4P2	C3P2	C2P2	C1P2	C0P2

**Fieldbus I/O module for DeviceNet™**  
**8 digital npn/pnp inputs**  
**8 digital outputs 0.5 A**  
**FDNP-L0808G-TT**

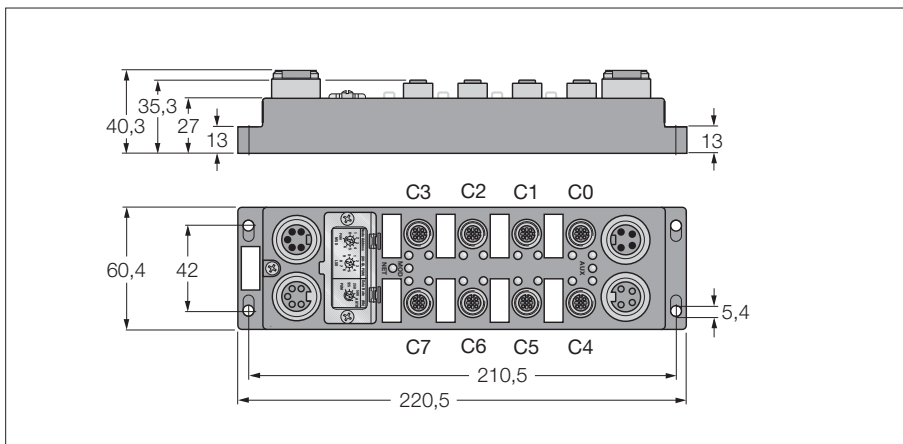

- 8 digital npn/pnp inputs and 8 digital outputs, 24 VDC 0.5 A
- Wire-break monitoring
- Short-circuit monitoring
- Channel-related diagnostics
- One channel per connector
- Separate actuator power supply
- Fibre-glass reinforced PA6 housing
- Vibration and shock-resistant
- Encapsulated module electronics
- Metal connector
- Degree of protection IP67

<b>Type</b>	FDNP-L0808G-TT
Ident-No.	6602389
<b>Operating / load voltage</b>	11...26 VDC
Operating current	< 100 mA
<b>Fieldbus transmission rate</b>	125 kbps to 500 kbps
Fieldbus addressing	0...63 (decimal) via coded rotary switches to operating and load voltage
Electrical isolation	
<b>Inputs</b>	
Number of channels	(8) 3-wire npn/pnp sensors
Input voltage	13...26 VDC
Input delay	2.5 ms
Switching frequency	≤ 100 Hz
Max. input current	6 mA
Electrical isolation	galvanic isolation against the bus
<b>Outputs</b>	
Number of channels	(8) DC actuators
Output voltage	24 VDC
Output current per channel	0.5 A, short-circuit proof
Load type	resistive, inductive, lamp load
Switching frequency	≤ 100 Hz
Simultaneity factor	1
Electrical isolation	galvanic isolation against the bus
<b>Sensor supply</b>	bus connection
Actuator power supply	separate (Aux)
<b>Operating temperature</b>	- 25... +70 °C

**Fieldbus 7/8"**

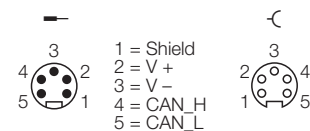

**Input M12 x 1**

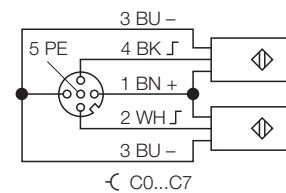

**Output M12 x 1**

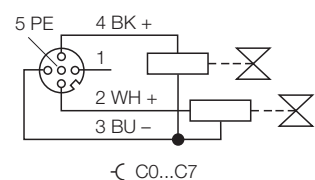

**Power supply 7/8"**

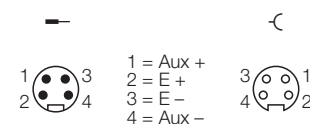

**Data in process image**

C1P4: Male Connector 1, 4-pole  
 APS: Auxiliary Status  
 ISS-3: Short-circuit channel 3  
 IOS-2: Wire-break channel 2  
 OS: Output status

		Bit 7	Bit 6	Bit 5	Bit 4	Bit 3	Bit 2	Bit 1	Bit 0
<b>Input</b>	<b>Byte 0</b>	C3P2	C3P4	C2P2	C2P4	C1P2	C1P4	C0P2	C0P4
	<b>Byte 1</b>	ISS-7	ISS-6	ISS-5	ISS-4	ISS-3	ISS-2	ISS-1	ISS-0
	<b>Byte 2</b>	IOS-7	IOS-6	IOS-5	IOS-4	IOS-3	IOS-2	IOS-1	IOS-0
	<b>Byte 3</b>	OS-7	OS-6	OS-5	OS-4	OS-3	OS-2	OS-1	OS-0
	<b>Byte 4</b>	-	APS	-	-	-	-	-	-
<b>Output</b>	<b>Byte 0</b>	C7P2	C7P4	C6P2	C6P4	C5P2	C5P4	C4P2	C4P4

**Fieldbus I/O module for DeviceNet™**  
**8 digital pnp inputs**  
**8 digital outputs 2 A**  
**FDNP-P0808H-TT**

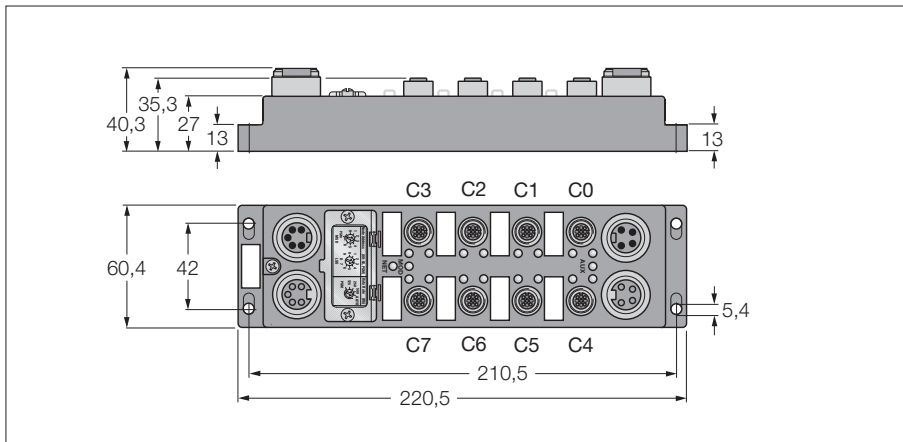

- 8 digital pnp inputs
- and 8 digital outputs, 24 VDC 2 A
- Wire-break monitoring
- Short-circuit monitoring
- Channel-related diagnostics
- One channel per connector
- Separate actuator power supply
- Fibre-glass reinforced PA6 housing
- Vibration and shock-resistant
- Encapsulated module electronics
- Metal connector
- Degree of protection IP67

<b>Type</b>	FDNP-P0808H-TT
Ident-No.	6603329
<b>Operating / load voltage</b>	11...26 VDC
Operating current	< 100 mA
<b>Fieldbus transmission rate</b>	125 kbps to 500 kbps
Fieldbus addressing	0...63 (decimal) via coded rotary switches to operating and load voltage
Electrical isolation	
<b>Inputs</b>	
Number of channels	(8) 3-wire pnp sensors
Input voltage	13...26 VDC
Input delay	2.5 ms
Switching frequency	≤ 100 Hz
Max. input current	6 mA
Electrical isolation	galvanic isolation against the bus
<b>Outputs</b>	
Number of channels	(8) DC actuators
Output voltage	24 VDC
Output current per channel	2.0 A, short-circuit proof
Load type	resistive, inductive, lamp load
Switching frequency	≤ 100 Hz
Simultaneity factor	0.5
Electrical isolation	galvanic isolation against the bus
<b>Sensor supply</b>	bus connection
Actuator power supply	separate (Aux)
<b>Operating temperature</b>	- 25... +70 °C

**Fieldbus 7/8"**

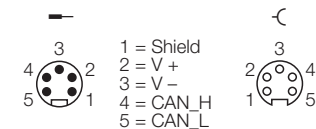

**Input M12 x 1**

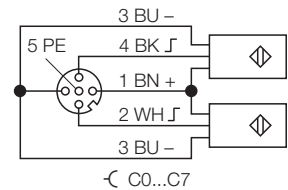

**Output M12 x 1**

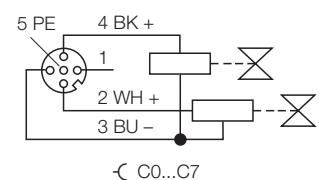

**Power supply 7/8"**

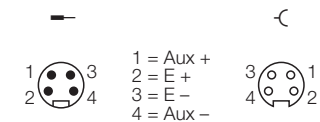

**Data in process image**

C1P4: Male Connector 1, 4-pole  
 APS: Auxiliary Status  
 ISS-3: Short-circuit channel 3  
 IOS-2: Wire-break channel 2  
 OS: Output status

		Bit 7	Bit 6	Bit 5	Bit 4	Bit 3	Bit 2	Bit 1	Bit 0
<b>Input</b>	<b>Byte 0</b>	C3P2	C3P4	C2P2	C2P4	C1P2	C1P4	C0P2	C0P4
	<b>Byte 1</b>	ISS-7	ISS-6	ISS-5	ISS-4	ISS-3	ISS-2	ISS-1	ISS-0
	<b>Byte 2</b>	IOS-7	IOS-6	IOS-5	IOS-4	IOS-3	IOS-2	IOS-1	IOS-0
	<b>Byte 3</b>	OS-7	OS-6	OS-5	OS-4	OS-3	OS-2	OS-1	OS-0
	<b>Byte 4</b>	-	APS	-	-	-	-	-	-
<b>Output</b>	<b>Byte 0</b>	C7P2	C7P4	C6P2	C6P4	C5P2	C5P4	C4P2	C4P4



**Fieldbus I/O module for DeviceNet™**  
**8 digital npn/pnp inputs**  
**8 digital outputs 2 A**  
**FDNP-L0808H-TT**

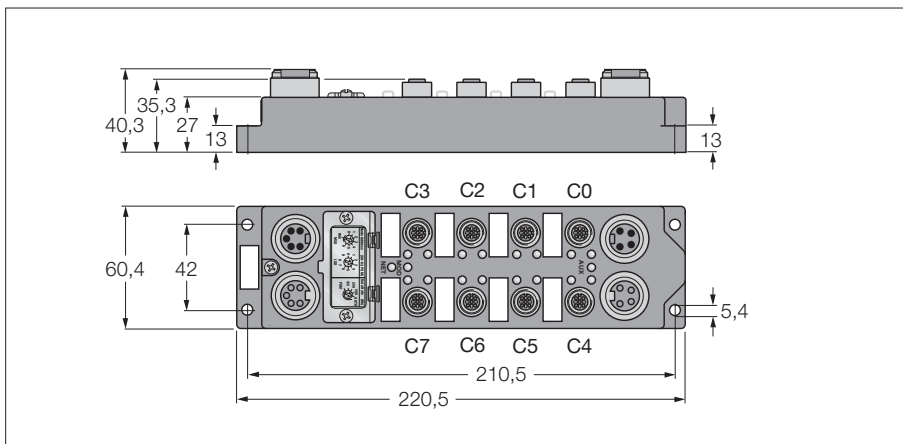

- 8 digital npn/pnp inputs
- and 8 digital outputs, 24 VDC 2 A
- Wire-break monitoring
- Short-circuit monitoring
- Channel-related diagnostics
- One channel per connector
- Separate actuator power supply
- Fibre-glass reinforced PA6 housing
- Vibration and shock-resistant
- Encapsulated module electronics
- Metal connector
- Degree of protection IP67

<b>Type</b>	FDNP-L0808H-TT
Ident-No.	6603328
<b>Operating / load voltage</b>	11...26 VDC
Operating current	< 100 mA
<b>Fieldbus transmission rate</b>	125 kbps to 500 kbps
Fieldbus addressing	0...63 (decimal) via coded rotary switches to operating and load voltage
Electrical isolation	
<b>Inputs</b>	
Number of channels	(8) 3-wire npn/pnp sensors
Input voltage	13...26 VDC
Input delay	2.5 ms
Switching frequency	≤ 100 Hz
Max. input current	6 mA
Electrical isolation	galvanic isolation against the bus
<b>Outputs</b>	
Number of channels	(8) DC actuators
Output voltage	24 VDC
Output current per channel	2.0 A, short-circuit proof
Load type	resistive, inductive, lamp load
Switching frequency	≤ 100 Hz
Simultaneity factor	0.5
Electrical isolation	galvanic isolation against the bus
<b>Sensor supply</b>	bus connection
Actuator power supply	separate (Aux)
<b>Operating temperature</b>	- 25... +70 °C

**Fieldbus 7/8"**

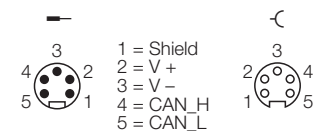

**Input M12 x 1**

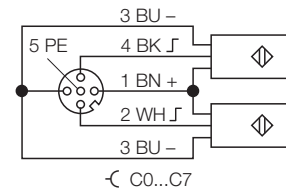

**Output M12 x 1**

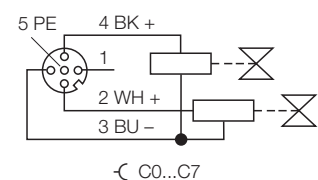

**Power supply 7/8"**

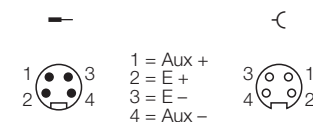

**Data in process image**

C1P4: Male Connector 1, 4-pole  
 APS: Auxiliary Status  
 ISS-3: Short-circuit channel 3  
 IOS-2: Wire-break channel 2  
 OS: Output status

		Bit 7	Bit 6	Bit 5	Bit 4	Bit 3	Bit 2	Bit 1	Bit 0
<b>Input</b>	<b>Byte 0</b>	C3P2	C3P4	C2P2	C2P4	C1P2	C1P4	C0P2	C0P4
	<b>Byte 1</b>	ISS-7	ISS-6	ISS-5	ISS-4	ISS-3	ISS-2	ISS-1	ISS-0
	<b>Byte 2</b>	IOS-7	IOS-6	IOS-5	IOS-4	IOS-3	IOS-2	IOS-1	IOS-0
	<b>Byte 3</b>	OS-7	OS-6	OS-5	OS-4	OS-3	OS-2	OS-1	OS-0
	<b>Byte 4</b>	-	APS	-	-	-	-	-	-
<b>Output</b>	<b>Byte 0</b>	C7P2	C7P4	C6P2	C6P4	C5P2	C5P4	C4P2	C4P4

**Fieldbus I/O module for DeviceNet™**  
**12 digital pnp inputs**  
**4 digital outputs 0.5 A**  
**FDNP-P1204G-TT**

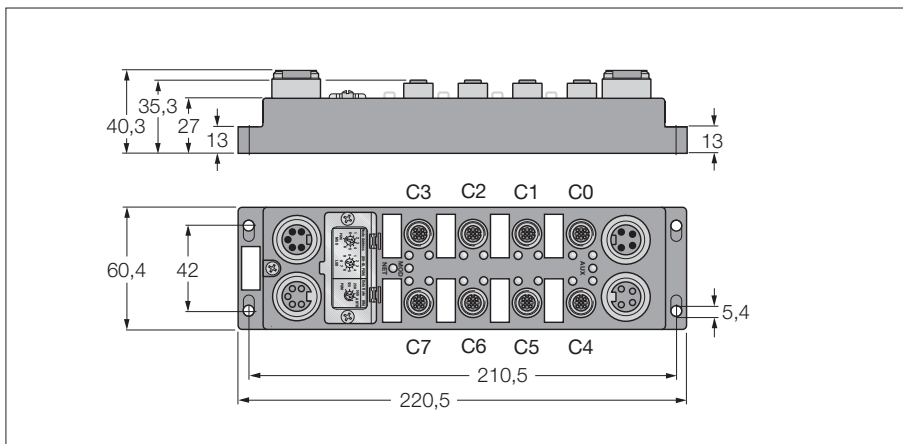

- 12 digital pnp inputs
- and 4 digital outputs, 24 VDC 0.5 A
- Wire-break monitoring
- Short-circuit monitoring
- Channel-related diagnostics
- One channel per connector
- Separate actuator power supply
- Fibre-glass reinforced PA6 housing
- Vibration and shock-resistant
- Encapsulated module electronics
- Metal connector
- Degree of protection IP67

<b>Type</b>	FDNP-P1204G-TT
Ident-No.	6602672
<b>Operating / load voltage</b>	11...26 VDC
Operating current	< 100 mA
<b>Fieldbus transmission rate</b>	125 kbps to 500 kbps
Fieldbus addressing	0...63 (decimal) via coded rotary switches to operating and load voltage
Electrical isolation	
<b>Inputs</b>	
Number of channels	(12) 3-wire pnp sensors
Input voltage	13...26 VDC
Input delay	2.5 ms
Switching frequency	≤ 100 Hz
Max. input current	6 mA
Electrical isolation	galvanic isolation against the bus
<b>Outputs</b>	
Number of channels	(4) DC actuators
Output voltage	24 VDC
Output current per channel	0.5 A, short-circuit proof
Load type	resistive, inductive, lamp load
Switching frequency	≤ 100 Hz
Simultaneity factor	1
Electrical isolation	galvanic isolation against the bus
<b>Sensor supply</b>	bus connection
Actuator power supply	separate (Aux)
<b>Operating temperature</b>	- 25... +70 °C

**Fieldbus 7/8"**

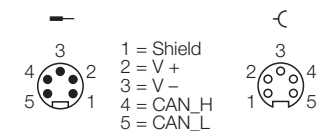

**Input M12 x 1**

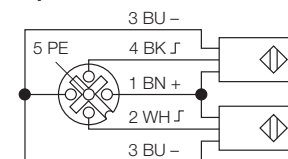

**Output M12 x 1**

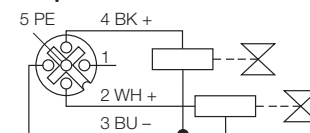

**Power supply 7/8"**

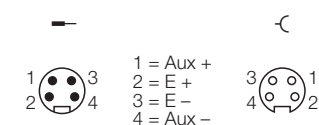

**Data in process image**

C1P4: Male Connector 1, 4-pole  
 APS: Auxiliary Status  
 ISS-3: Short-circuit channel 3  
 IOS-2: Wire-break channel 2  
 OS: Output status

		Bit 7	Bit 6	Bit 5	Bit 4	Bit 3	Bit 2	Bit 1	Bit 0
<b>Input</b>	<b>Byte 0</b>	C5P2	C5P4	C3P2	C3P4	C2P2	C2P4	C1P2	C1P4
	<b>Byte 1</b>	-	APS	-	-	C7P2	C7P4	C6P2	C6P4
	<b>Byte 2</b>	ISS-7	ISS-6	ISS-5	ISS-4	ISS-3	ISS-2	ISS-1	ISS-0
	<b>Byte 3</b>	OSS-3	OSS-2	OSS-1	OSS-0	IOS-11	IOS-10	IOS-9	IOS-8
	<b>Byte 4</b>	IOS-7	IOS-6	IOS-5	IOS-4	IOS-3	IOS-2	IOS-1	IOS-0
	<b>Byte 5</b>	OOS-3	OOS-2	OOS-1	OOS-0	IOS-11	IOS-10	IOS-9	IOS-8
<b>Output</b>	<b>Byte 0</b>	-	-	-	-	C4P2	C4P4	C0P2	C0P4

**Fieldbus I/O module for DeviceNet™**  
**16 configurable digital channels**  
**Pnp inputs / outputs 0.5 A**  
**FDNP-XSG16-TT**

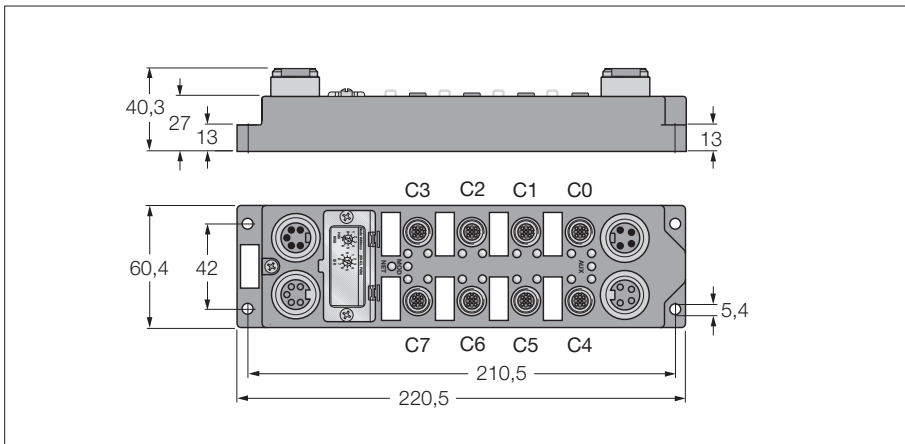

- 16 configurable digital channels
- Short-circuit monitoring
- Module-related diagnostics
- Two channel per connector
- Separate actuator power supply
- Fibre-glass reinforced PA6 housing
- Vibration and shock-resistant
- Encapsulated module electronics
- Metal connector
- Degree of protection IP67

<b>Type</b>	FDNP-XSG16-TT
Ident-No.	6603323
<b>Operating / load voltage</b>	11...26 VDC
Operating current	< 75 mA
<b>Fieldbus transmission rate</b>	125 kbps to 500 kbps
Fieldbus addressing	0...63 (decimal) via coded rotary switches to operating and load voltage
Electrical isolation	
<b>Inputs</b>	
Number of channels	(16) 3-wire pnp sensors
Input voltage	13...26 VDC
Input delay	2.5 ms
Switching frequency	≤ 100 Hz
Max. input current	6 mA
Electrical isolation	galvanic isolation against the bus
<b>Outputs</b>	
Number of channels	(16) DC actuators
Output voltage	24 VDC
Output current per channel	0.5 A, short-circuit proof
Load type	resistive, inductive, lamp load
Switching frequency	≤ 100 Hz
Simultaneity factor	1
Electrical isolation	galvanic isolation against the bus
<b>Sensor supply</b>	bus connection
Actuator power supply	separate (Aux)
<b>Operating temperature</b>	- 40... +70 °C

**Fieldbus 7/8"**

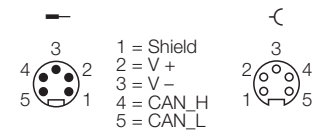

**Input M12 x 1**

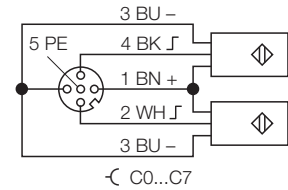

**Output M12 x 1**

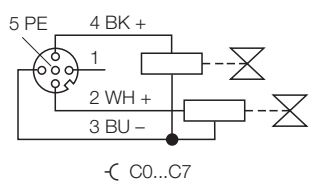

**Power supply 7/8"**

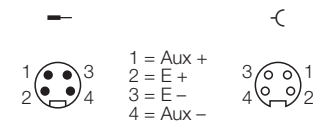

**Data in process image**

C1P4: Male Connector 1, 4-pole  
 IGS: Wire-break/ short circuit - group signal  
 OGS: Short-circuit - group signal

		Bit 7	Bit 6	Bit 5	Bit 4	Bit 3	Bit 2	Bit 1	Bit 0
<b>Input</b>	<b>Byte 0</b>	C3P2	C3P4	C2P2	C2P4	C1P2	C1P4	C0P2	C0P4
	<b>Byte 1</b>	C7P2	C7P4	C6P2	C6P4	C5P2	C5P4	C4P2	C4P4
	<b>Byte 2</b>	IGS	OGS	-	-	-	-	-	-
<b>Output</b>	<b>Byte 0</b>	C3P2	C3P4	C2P2	C2P4	C1P2	C1P4	C0P2	C0P4
	<b>Byte 1</b>	C7P2	C7P4	C6P2	C6P4	C5P2	C5P4	C4P2	C4P4

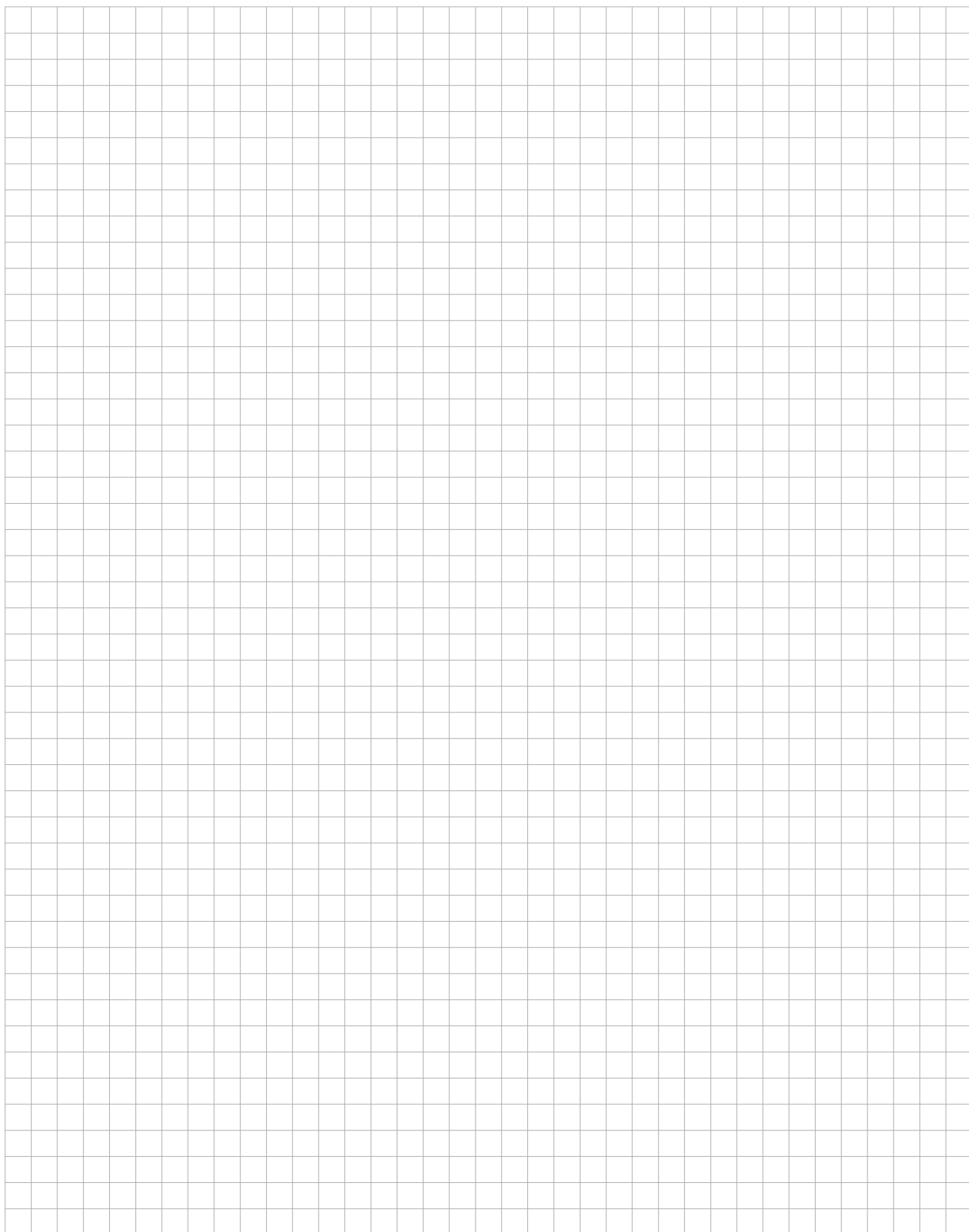

# Compact fieldbus I/O modules in IP67 for Ethernet

## Type code

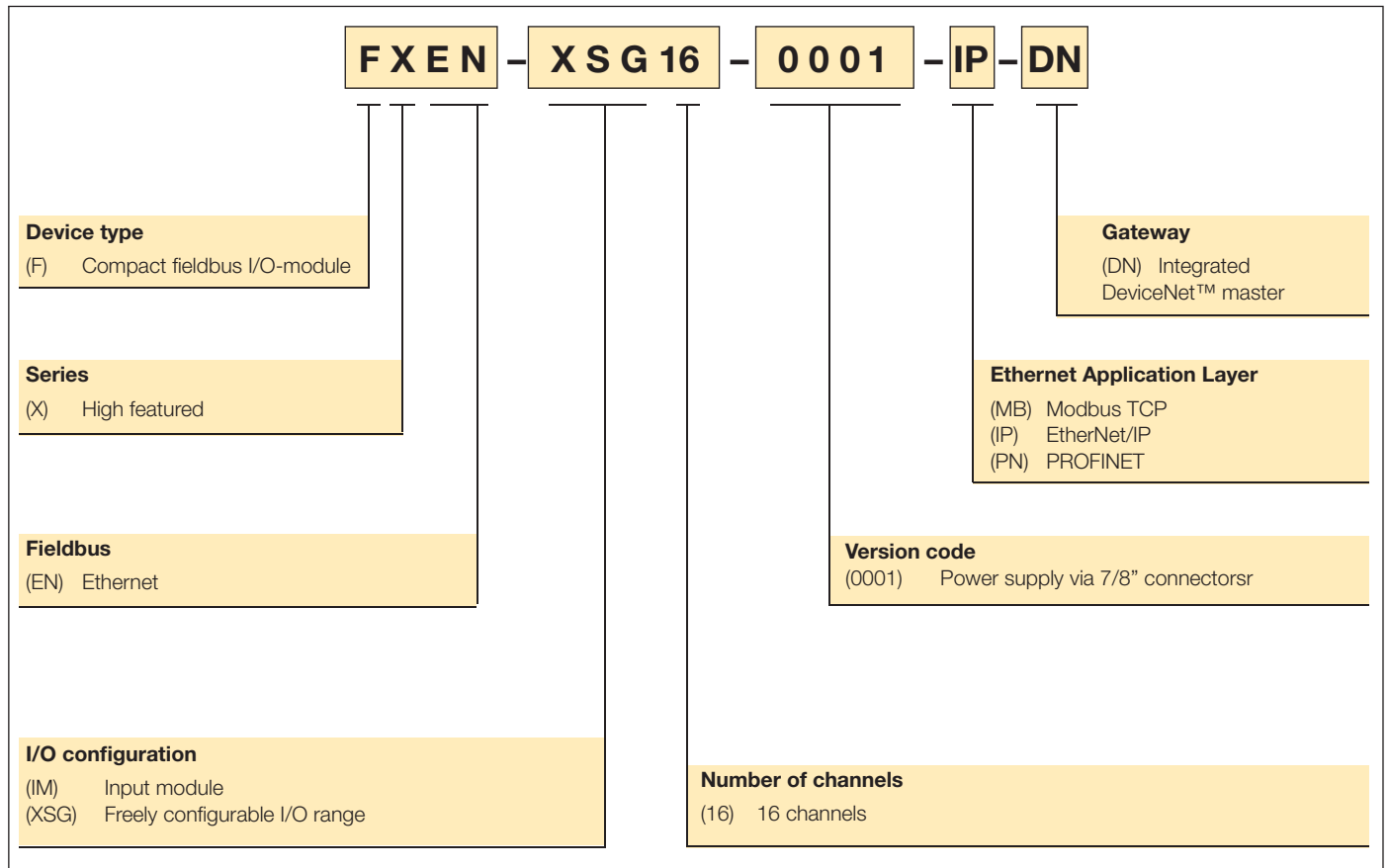



# Compact fieldbus I/O modules in IP67 for Ethernet

**TURCK**

Industrial  
Automation

Series FXEN



- Compact flat housing with up to 16 channels,
- Channel-specific diagnostics
- Integrated Ethernet switch
- Freely configurable I/Os

# Compact fieldbus I/O modules in IP67 for Ethernet

## Selection guide

		Number of inputs	Number of outputs	Number of inputs/outputs per connectot	Maximum load current [A]	DeviceNet™ master	Page
<b>Modbus TCP</b>	<b>Ident-no.</b>						
FXEN-IM16-0001-MB	6825411	16	-	2/-	-	-	308
FXEN-XSG16-0001-MB	6825412	16 configurable channels			1,4	-	309
<b>EtherNet/IP</b>							
FXEN-IM16-0001-IP	6825413	16	-	2/-	-	-	310
FXEN-XSG16-0001-IP	6825414	16 configurable channels			1,4	-	312
FXEN-IM16-0001-IP-DN	6825415	16	-	2/-	-	•	311
<b>PROFINET</b>							
FXEN-IM16-0001-PN	6825416	16	-	2/-	-	-	313
FXEN-XSG16-0001-PN	6825417	16 configurable channels			1,4	-	314

# Compact fieldbus I/O modules in IP67 for Ethernet

**TURCK**

Industrial  
Automation

## Series FXEN – general information



The compact FXEN fieldbus I/O modules allow direct connection of up to 16 inputs/outputs to an Ethernet network. The Ethernet application layer Modbus TCP, EtherNet/IP and PROFINET can be processed by a wide range of product variants. The I/O modules offer channel-specific diagnostics of the outputs and a module slot specific short-circuit diagnostics of the inputs, as well as supporting transmission rates of 10/100 Mbps. The Ethernet connection is implemented with a 4-pole, D-coded M12 x 1-round connector.

The integrated Ethernet switch allows the creation of a linear topology with the I/O modules. The module is powered via a 7/8" round connector and can be fed through via a second 7/8" round connector. The I/O level is equipped throughout with M12 metal round connectors. Glass-fibre reinforced plastic housings and the fully encapsulated module electronics guarantee protection degree IP67. The I/O modules are therefore particularly suited for use in harsh industrial environments.

### General technical data

#### Application layer

BOOTP, DHCP, SNMP  
MODBUS TCP  
EtherNet/IP  
PROFINET

Standard IT protocols and services  
I/O data exchange Modbus TCP (FXEN-...-MB)  
I/O data exchange EtherNet/IP (FXEN-...-IP)  
I/O data exchange PROFINet (FXEN-...-PN)

#### Settings

BOOTP  
DHCP  
PGM  
PGM-DHCP  
PROFINet  
Static Rotary

Dynamic IP address assignment via BOOTP server  
Dynamic IP address assignment via DHCP server  
Manual address assignment via addressing tool (e.g. I/O-ASSISTANT)  
Specific addressing mode for EtherNet/IP  
Specific addressing mode for PROFINET  
The last three figures of the IP address are set with the three coded rotary switches. The other values of the IP address are default settings.  
The three rotary coding switches are each set to 0 (default IP address 192.168.1.254)

192.168.1.000  
Transmission rate

10 / 100 Mbps

#### LEDs

Inputs (dual colour LED)  
Outputs (dual colour LED)  
Power supply (dual colour LED)  
LINK ACT (dual colour LED)

green: Input, actuated, red: Overload sensor supply  
green: output switched  
red: overload output  
green: Operating and load voltage in the operating range, red: load voltage < 18 VDC  
OFF: operational voltage < 18 VDC  
red: 10 Mbps, (flashes during data transfer) green: 100 Mbps

#### Connections

Ethernet (integrated Ethernet switch)  
Power supply  
Inputs/outputs

Nickel-plated brass  
2 x M12, 4-pole, D-coded  
2 x 7/8", 5-pole  
8 x M12 (5-pole)

#### Housing

Mounting  
Degree of protection (IEC 60529/EN 60529)  
Vibration and shock tested  
EMC  
Temperature range  
– Operating temperature  
– Storage and transport temperature  
Dimensions

PA6-GF30, glass-fibre reinforced plastic housing with encapsulated electronics and nickel-plated brass connectors  
via 4 through-holes, Ø 5.4 mm  
IP67  
according to EN 60068-2-6, 2-27  
acc. to EN 61000-6-2, IEC 61000-6-4  
0 °C to +55 °C (+32 °F to +131 °F)  
-25 °C to +70 °C (-13 °F to +158 °F)  
220.5 x 62.4 x 27 mm (H x W x D)

#### Approvals

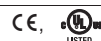

# Fieldbus I/O module for Ethernet Modbus TCP

## 16 digital pnp inputs

### FXEN-IM16-0001-MB

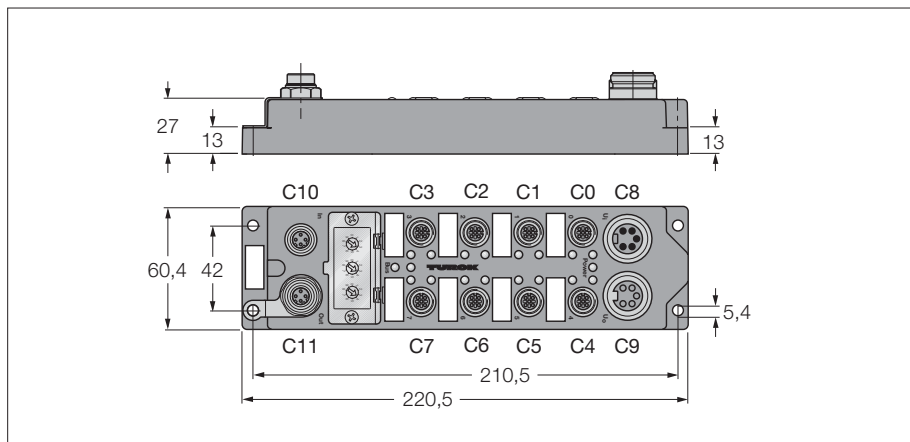

- 16 digital pnp inputs
- For Modbus TCP applications
- Integrated Ethernet switch
- Supported via FDT/DTM
- Input diagnostics per slot
- Two channels per connector
- Fibre-glass reinforced PA6 housing
- Vibration and shock-resistant
- Encapsulated module electronics
- Metal connector
- Degree of protection IP67

<b>Type</b>	FXEN-IM16-0001-MB
Ident-No.	6825411
<b>Operating / load voltage</b>	18...30 VDC
Operating current	< 75 mA
<b>Transmission rate Ethernet</b>	10 Mbps / 100 Mbps
Addressing modes Ethernet:	Static IP, BOOTP, DHCP, PGM, PGM-DHCP
Electrical isolation	to operating and load voltage
<b>Inputs</b>	
Number of channels	(16) 3-wire pnp sensors
Input voltage	18...30 VDC via operating voltage
Supply current	< 120 mA per channel, short-circuit proof
Switching threshold	2 mA / 4 mA
Input delay	2.5 ms
Max. input current	6 mA
Electrical isolation	galvanic isolation against Ethernet
<b>Operating temperature</b>	0 to 55 °C

#### Ethernet M12 x 1

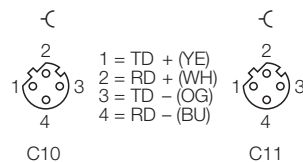

#### Input M12 x 1

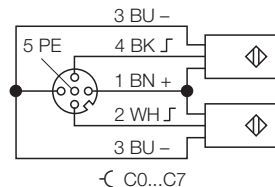

#### Power supply 7/8"

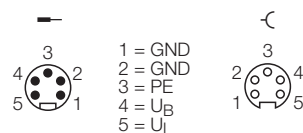

#### Data in process image

C1P4: Male Connector 1, 4-pole

		Bit 7	Bit 6	Bit 5	Bit 4	Bit 3	Bit 2	Bit 1	Bit 0
Input	Byte 0	C3P2	C3P4	C2P2	C2P4	C1P2	C1P4	C0P2	C0P4
	Byte 1	C7P2	C7P4	C6P2	C6P4	C5P2	C5P4	C4P2	C4P4

**Fieldbus I/O module for Ethernet Modbus TCP**  
**16 configurable digital channels**  
**Pnp inputs / outputs 1.4 A**  
**FXEN-XSG16-0001-MB**

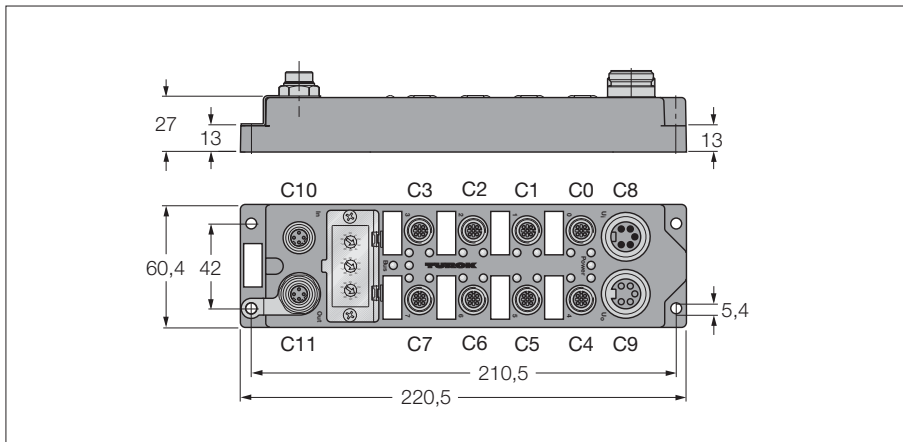

- 16 configurable digital channels
- For Modbus TCP applications
- Integrated Ethernet switch
- Supported via FDT/DTM
- Input diagnostics per slot
- Two channels per connector
- Two channels per connector
- Fibre-glass reinforced PA6 housing
- Vibration and shock-resistant
- Encapsulated module electronics
- Metal connector
- Degree of protection IP67

<b>Type</b>	FXEN-XSG16-0001-MB
Ident-No.	6825412
<b>Operating / load voltage</b>	18...30 VDC
Operating current	< 75 mA
<b>Transmission rate Ethernet</b>	10 Mbps / 100 Mbps
Addressing modes Ethernet:	Static IP, BOOTP, DHCP, PGM, PGM-DHCP
Electrical isolation	to operating and load voltage
<b>Inputs</b>	
Number of channels	(16) 3-wire pnp sensors
Input voltage	18...30 VDC via operating voltage
Supply current	< 120 mA per channel, short-circuit proof
Switching threshold	2 mA / 4 mA
Input delay	2.5 ms
Max. input current	6 mA
Electrical isolation	galvanic isolation against Ethernet
<b>Outputs</b>	
Number of channels	(16) DC actuators
Output voltage	18...30 VDC from load voltage
Output current per channel	1.4 A, short-circuit proof
Load type	resistive, inductive, lamp load
Simultaneity factor	0.4
Electrical isolation	galvanic isolation against Ethernet
<b>Operating temperature</b>	0 to 55 °C

**Ethernet M12 x 1**

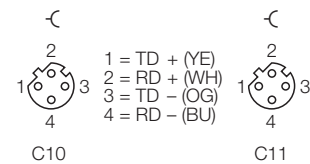

**Input M12 x 1**

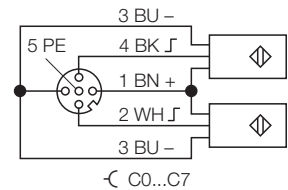

**Output M12 x 1**

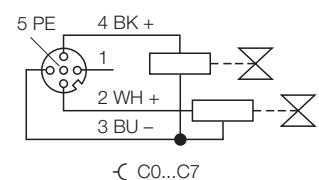

**Power supply 7/8"**

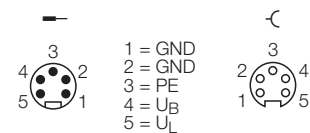

**Data in process image**

C1P4: Male Connector 1, 4-pole

		Bit 7	Bit 6	Bit 5	Bit 4	Bit 3	Bit 2	Bit 1	Bit 0
Input	Byte 0	C3P2	C3P4	C2P2	C2P4	C1P2	C1P4	C0P2	C0P4
	Byte 1	C7P2	C7P4	C6P2	C6P4	C5P2	C5P4	C4P2	C4P4
Output	Byte 0	C3P2	C3P4	C2P2	C2P4	C1P2	C1P4	C0P2	C0P4
	Byte 1	C7P2	C7P4	C6P2	C6P4	C5P2	C5P4	C4P2	C4P4

# Fieldbus I/O module for EtherNet/IP

## 16 digital pnp inputs

### FXEN-IM16-0001-IP

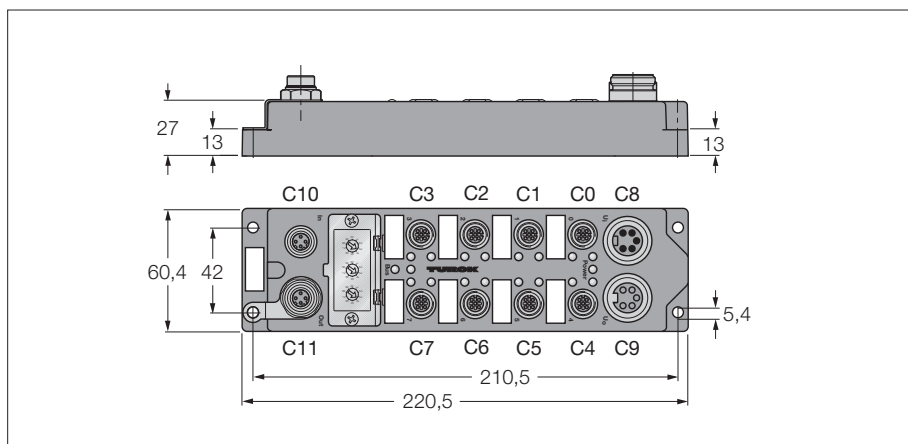

- 16 digital pnp inputs
- For EtherNet/IP applications
- Integrated Ethernet switch
- Supported via FDT/DTM
- Input diagnostics per slot
- Two channels per connector
- Fibre-glass reinforced PA6 housing
- Vibration and shock-resistant
- Encapsulated module electronics
- Metal connector
- Degree of protection IP67

<b>Type</b>	FXEN-IM16-0001-IP
Ident-No.	6825413
<b>Operating / load voltage</b>	18...30 VDC
Operating current	< 75 mA
<b>Transmission rate Ethernet</b>	10 MBit/s / 100 MBit/s
Addressing modes Ethernet:	Static IP, BOOTP, DHCP, PGM, PGM-DHCP
Electrical isolation	to operating and load voltage
<b>Inputs</b>	
Number of channels	(16) 3-wire pnp sensors
Input voltage	18...30 VDC via operating voltage
Supply current	< 120 mA per channel, short-circuit proof
Switching threshold	2 mA / 4 mA
Input delay	2.5 ms
Max. input current	6 mA
Electrical isolation	galvanic isolation against Ethernet
<b>Operating temperature</b>	0...55 °C

#### Ethernet M12 x 1

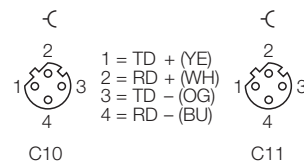

#### Input M12 x 1

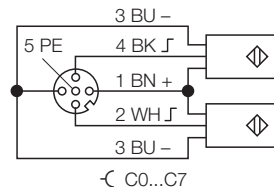

#### Power supply 7/8"

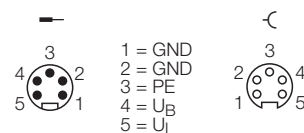

#### Data in process image

C1P4: Male Connector 1, 4-pole

		Bit 7	Bit 6	Bit 5	Bit 4	Bit 3	Bit 2	Bit 1	Bit 0
Input	Byte 0	C3P2	C3P4	C2P2	C2P4	C1P2	C1P4	C0P2	C0P4
	Byte 1	C7P2	C7P4	C6P2	C6P4	C5P2	C5P4	C4P2	C4P4

**Fieldbus I/O module for EtherNet/IP**  
**EtherNet/IP - DeviceNet Gateway**  
**16 digital pnp inputs**  
**FXEN-IM16-0001-IP-DN**

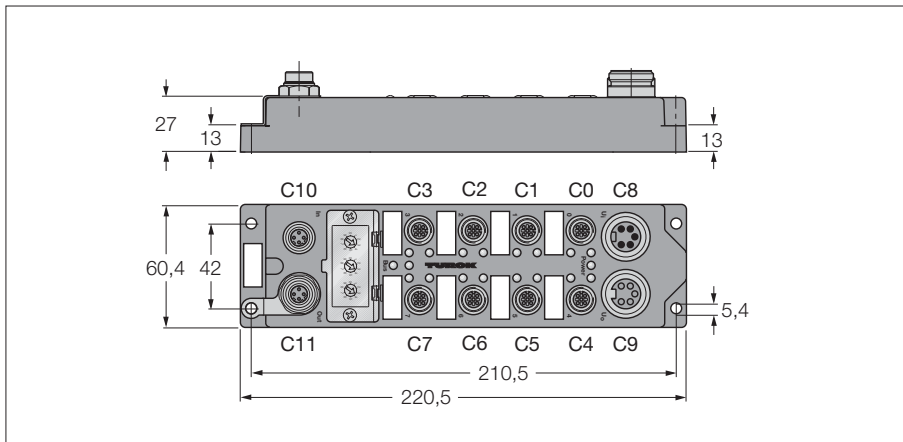

- EtherNet/IP - DeviceNet Gateway
- EtherNet/IP Slave
- DeviceNet Master
- 16 digital pnp inputs
- For EtherNet/IP applications
- Integrated Ethernet switch
- Supported via FDT/DTM
- Input diagnostics per slot
- Two channels per connector
- Fibre-glass reinforced PA6 housing
- Vibration and shock-resistant
- Encapsulated module electronics
- Metal connector
- Degree of protection IP67

<b>Type</b>	FXEN-IM16-0001-IP-DN
Ident-No.	6825415
<b>Operating / load voltage</b>	18...30 VDC
Operating current	< 75 mA
<b>Transmission rate Ethernet</b>	10 MBit/s / 100 MBit/s
Addressing modes Ethernet:	Static IP, BOOTP, DHCP, PGM, PGM-DHCP
Electrical isolation	to operating and load voltage
<b>Inputs</b>	
Number of channels	(16) 3-wire pnp sensors
Input voltage	18...30 VDC via operating voltage
Supply current	< 120 mA per channel, short-circuit proof
Switching threshold	2 mA / 4 mA
Input delay	2.5 ms
Max. input current	6 mA
Electrical isolation	galvanic isolation against Ethernet
<b>Operating temperature</b>	0...55 °C

**Ethernet M12 x 1**

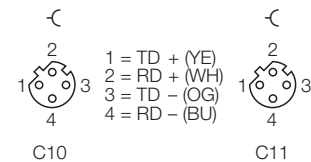

**Input M12 x 1**

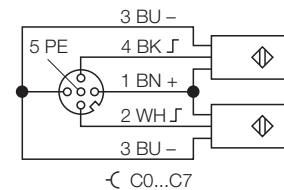

**DeviceNet 7/8"**

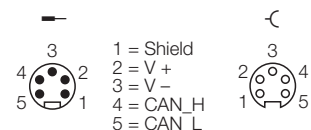

**Data in process image**

C1P4: Male Connector 1, 4-pole

		Bit 7	Bit 6	Bit 5	Bit 4	Bit 3	Bit 2	Bit 1	Bit 0
Input	Byte 0	C3P2	C3P4	C2P2	C2P4	C1P2	C1P4	C0P2	C0P4
	Byte 1	C7P2	C7P4	C6P2	C6P4	C5P2	C5P4	C4P2	C4P4



**Fieldbus I/O module for EtherNet/IP**  
**16 configurable digital channels**  
**Pnp inputs / outputs 1.4 A**  
**FXEN-XSG16-0001-IP**

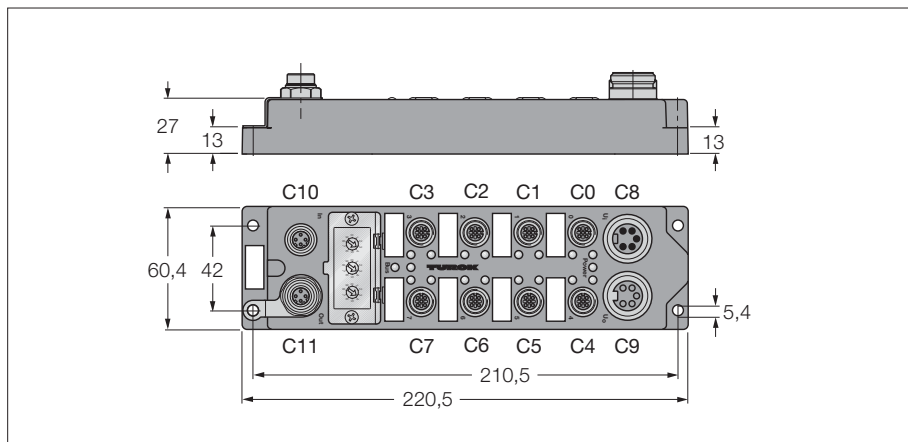

- 16 configurable digital channels
- For EtherNet/IP applications
- Integrated Ethernet switch
- Supported via FDT/DTM
- Input diagnostics per slot
- Output diagnostics per channel
- Two channels per connector
- Fibre-glass reinforced PA6 housing
- Vibration and shock-resistant
- Encapsulated module electronics
- Metal connector
- Degree of protection IP67

<b>Type</b>	FXEN-XSG16-0001-IP
Ident-No.	6825414
<b>Operating / load voltage</b>	18...30 VDC
Operating current	< 75 mA
<b>Transmission rate Ethernet</b>	10 MBit/s / 100 MBit/s
Addressing modes Ethernet:	Static IP, BOOTP, DHCP, PGM, PGM-DHCP
Electrical isolation	to operating and load voltage
<b>Inputs</b>	
Number of channels	(16) 3-wire pnp sensors
Input voltage	18...30 VDC via operating voltage
Supply current	< 120 mA per channel, short-circuit proof
Switching threshold	2 mA / 4 mA
Input delay	2.5 ms
Max. input current	6 mA
Electrical isolation	galvanic isolation against Ethernet
<b>Outputs</b>	
Number of channels	(16) DC actuators
Output voltage	18...30 VDC from load voltage
Output current per channel	1.4 A, short-circuit proof
Load type	resistive, inductive, lamp load
Simultaneity factor	0.4
Electrical isolation	galvanic isolation against Ethernet
<b>Operating temperature</b>	0...55 °C

**Ethernet M12 x 1**

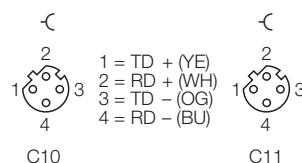

**Input M12 x 1**

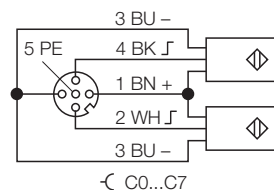

**Output M12 x 1**

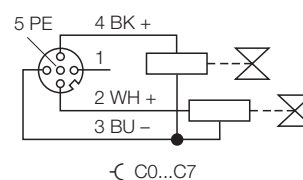

**Power supply 7/8"**

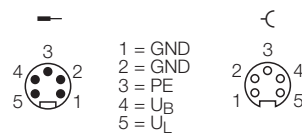

**Data in process image**

C1P4: Male Connector 1, 4-pole

		Bit 7	Bit 6	Bit 5	Bit 4	Bit 3	Bit 2	Bit 1	Bit 0
Input	Byte 0	C3P2	C3P4	C2P2	C2P4	C1P2	C1P4	C0P2	C0P4
	Byte 1	C7P2	C7P4	C6P2	C6P4	C5P2	C5P4	C4P2	C4P4
Output	Byte 0	C3P2	C3P4	C2P2	C2P4	C1P2	C1P4	C0P2	C0P4
	Byte 1	C7P2	C7P4	C6P2	C6P4	C5P2	C5P4	C4P2	C4P4



**Fieldbus I/O module for PROFINET**  
**16 digital pnp inputs**  
**FXEN-IM16-0001-PN**

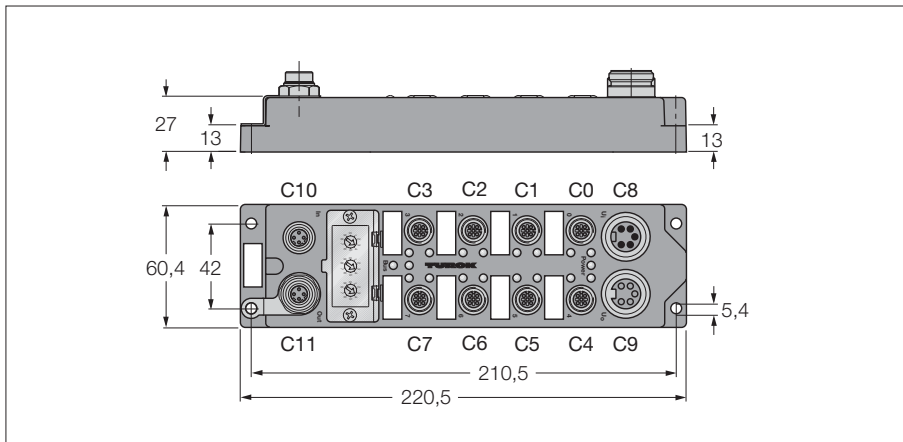

- 16 digital pnp inputs
- For PROFINET applications
- Integrated Ethernet switch
- Supported via FDT/DTM
- Input diagnostics per slot
- Two channels per connector
- Fibre-glass reinforced PA6 housing
- Vibration and shock-resistant
- Encapsulated module electronics
- Metal connector
- Degree of protection IP67

<b>Type</b>	FXEN-IM16-0001-PN
Ident-No.	6825416
<b>Operating / load voltage</b>	18...30 VDC
Operating current	< 75 mA
<b>Transmission rate Ethernet</b>	10 Mbps / 100 Mbps
Addressing modes Ethernet:	BOOTP, DHCP, PGM, PROFINET, BOOTP-safe
Electrical isolation	to operating and load voltage
<b>Inputs</b>	
Number of channels	(16) 3-wire pnp sensors
Input voltage	18...30 VDC via operating voltage
Supply current	< 120 mA per channel, short-circuit proof
Switching threshold	2 mA / 4 mA
Input delay	2.5 ms
Max. input current	6 mA
Electrical isolation	galvanic isolation against Ethernet
<b>Operating temperature</b>	0...55 °C

**Ethernet M12 x 1**

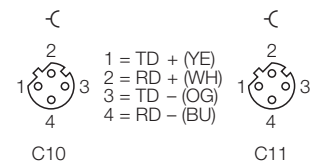

**Input M12 x 1**

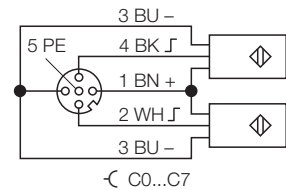

**Power supply 7/8"**

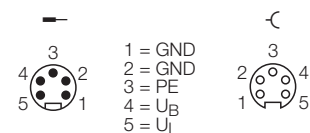

**Data in process image**

C1P4: Male Connector 1, 4-pole

		Bit 7	Bit 6	Bit 5	Bit 4	Bit 3	Bit 2	Bit 1	Bit 0
Input	Byte 0	C3P2	C3P4	C2P2	C2P4	C1P2	C1P4	C0P2	C0P4
	Byte 1	C7P2	C7P4	C6P2	C6P4	C5P2	C5P4	C4P2	C4P4

**Fieldbus I/O module for PROFINET**  
**16 configurable digital channels**  
**Pnp inputs / outputs 1.4 A**  
**FXEN-XSG16-0001-PN**

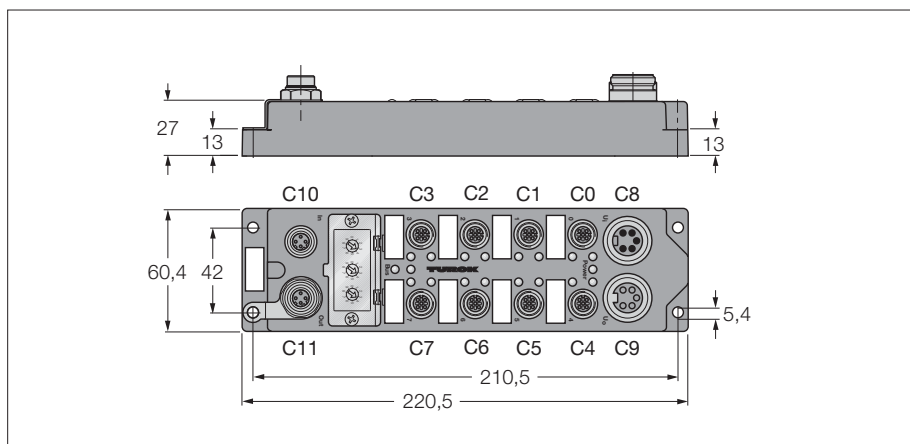

- 16 configurable digital channels
- For PROFINET applications
- Integrated Ethernet switch
- Supported via FDT/DTM
- Input diagnostics per slot
- Output diagnostics per channel
- Two channels per connector
- Fibre-glass reinforced PA6 housing
- Vibration and shock-resistant
- Encapsulated module electronics
- Metal connector
- Degree of protection IP67

<b>Type</b>	FXEN-XSG16-0001-PN
Ident-No.	6825417
<b>Operating / load voltage</b>	18...30 VDC
Operating current	< 75 mA
<b>Transmission rate Ethernet</b>	10 Mbps / 100 Mbps
Addressing modes Ethernet:	BOOTP, DHCP, PGM, PROFINet, BOOTP-safe
Electrical isolation	to operating and load voltage
<b>Inputs</b>	
Number of channels	(16) 3-wire pnp sensors
Input voltage	18...30 VDC via operating voltage
Supply current	< 120 mA per channel, short-circuit proof
Switching threshold	2 mA / 4 mA
Input delay	2.5 ms
Max. input current	6 mA
Electrical isolation	galvanic isolation against Ethernet
<b>Outputs</b>	
Number of channels	(16) DC actuators
Output voltage	18...30 VDC from load voltage
Output current per channel	1.4 A, short-circuit proof
Load type	resistive, inductive, lamp load
Simultaneity factor	0.4
Electrical isolation	galvanic isolation against Ethernet
<b>Operating temperature</b>	0...55 °C

**Ethernet M12 x 1**

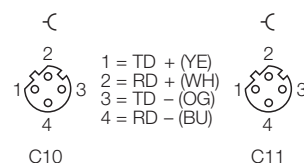

**Input M12 x 1**

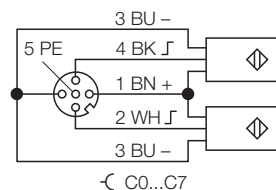

**Output M12 x 1**

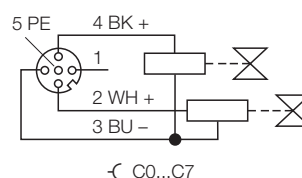

**Power supply 7/8"**

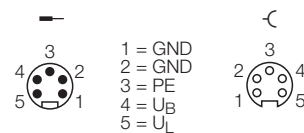

**Data in process image**

C1P4: Male Connector 1, 4-pole

		Bit 7	Bit 6	Bit 5	Bit 4	Bit 3	Bit 2	Bit 1	Bit 0
Input	Byte 0	C3P2	C3P4	C2P2	C2P4	C1P2	C1P4	C0P2	C0P4
	Byte 1	C7P2	C7P4	C6P2	C6P4	C5P2	C5P4	C4P2	C4P4
Output	Byte 0	C3P2	C3P4	C2P2	C2P4	C1P2	C1P4	C0P2	C0P4
	Byte 1	C7P2	C7P4	C6P2	C6P4	C5P2	C5P4	C4P2	C4P4



# Compact fieldbus I/O-modules in IP20

## Type code

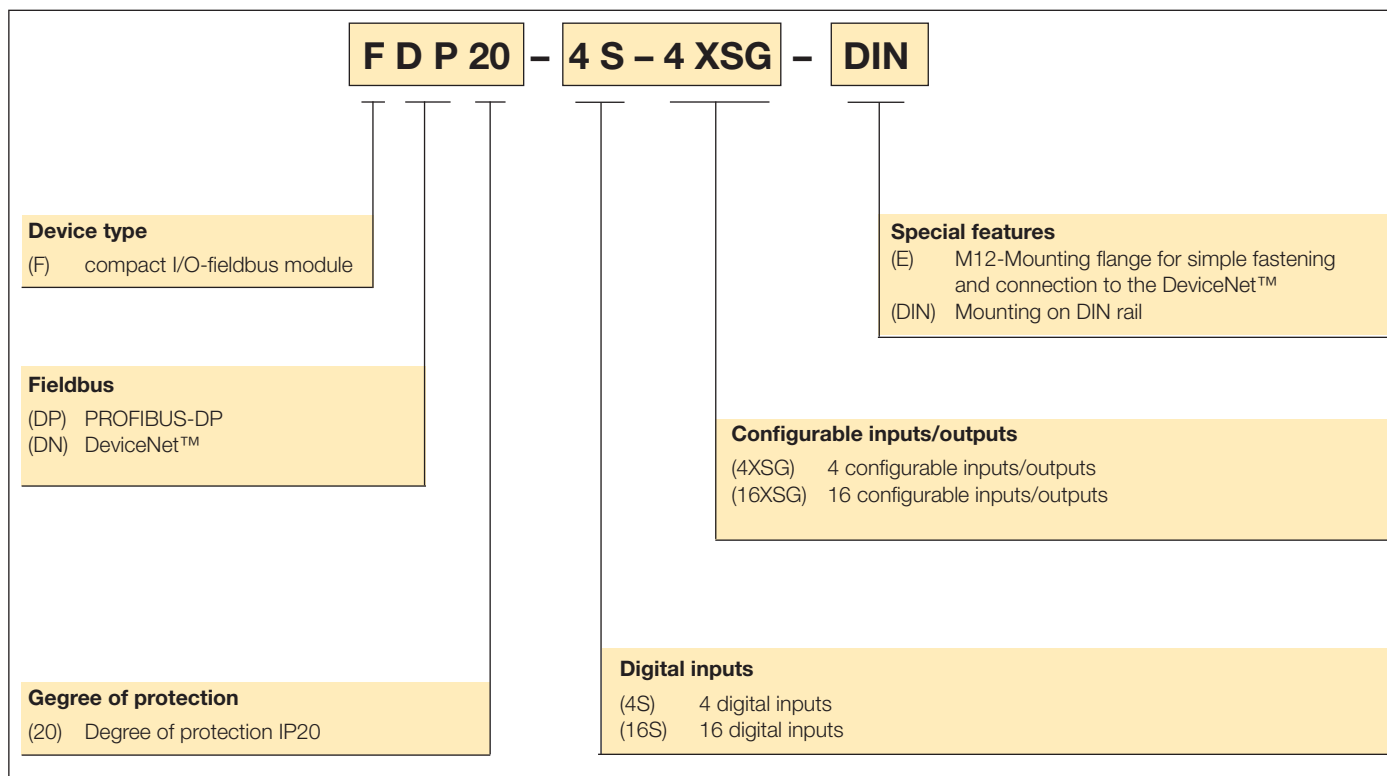

Series FDN/FDP with 16 channels



Series FDN with 8 channels



- Extremely compact for restricted space conditions
- High flexibility through freely configurable I/Os
- Different potential groups for the I/O range
- Inputs: PNP, short-circuit protected
- Outputs: 0.5 A and 1.8 A (FDN20-16XSG), short-circuit protected
- Extended temperature range  
DeviceNet™: -40...+70 °C  
PROFIBUS-DP 0...+55 °C

## Small housing style, flexible and inexpensive

The new compact IP20 modules are designed for use where conventional I/O bus terminal systems are unsuitable due to their large dimensions. In applications with a small number of signals, they have the edge on modular systems.

Low space requirements as well as simple handling make work easy for the design engineer and ensures fast setup.

Depending on type, the modules offer 8 or 16 digital channels. If necessary these can be configured as inputs or outputs, with the I/O supply circuits arranged in three galvanically isolated levels. In this way the modules offer optimum flexibility in an extremely compact design.

**Fieldbus I/O module for PROFIBUS-DP**  
**16 configurable channels**  
**FDP20-16XSG**

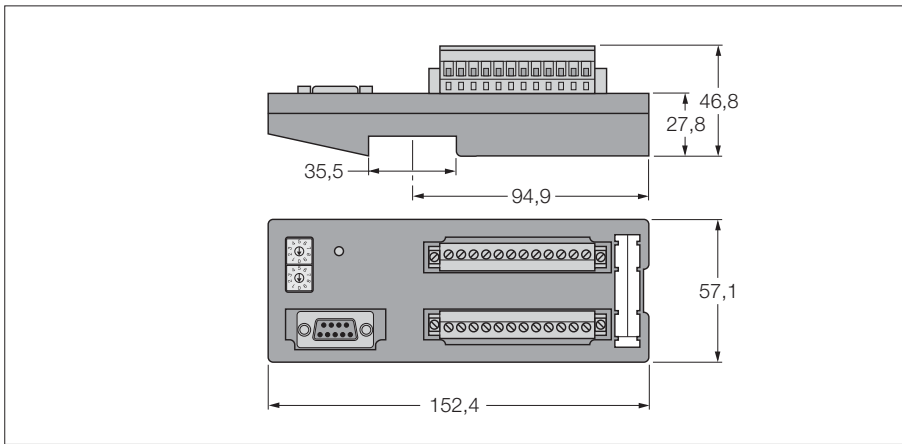

- Rotary coding switch for adjustment of the node address
- Degree of protection IP20
- 3 I/O power supply groups each galvanically isolated
- 16 configurable channels, DI or DO
- 24 VDC, pnp
- Output current: 0.5 A

<b>Type</b>	FDP20-16XSG
Ident-No.	6611466
<b>Number of channels</b>	16
Electrical isolation	I/Os to PROFIBUS
Internal power consumption	< 75 mA plus I/O supply
Admissible range field supply	18...30VDC
Electrical isolation	I/Os to PROFIBUS
<b>Fieldbus transmission rate</b>	9.6 kbps up to 12 Mbps
Fieldbus addressing range	1...99
Fieldbus addressing	2 decimally coded rotary switches
<b>Inputs</b>	
Input voltage	18...30VDC
Low level signal voltage	< 4 V
High level signal voltage	8...24 V
Low level signal current	< 0.5 mA
High level signal current	1...3.4 mA
Input delay	2,5 ms
Max. input current	700 mA
<b>Outputs</b>	
Output voltage	18...30 VDC, short-circuit proof
Output current per channel	0.5A (from Aux)
Switching frequency	≤ 100 Hz
<b>Operating temperature</b>	0°C...55°C

**Fieldbus**

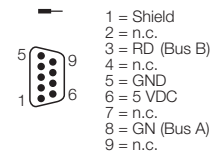

**Wiring diagram**

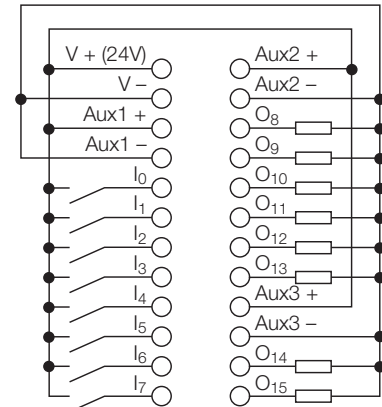

**Wiring diagram**

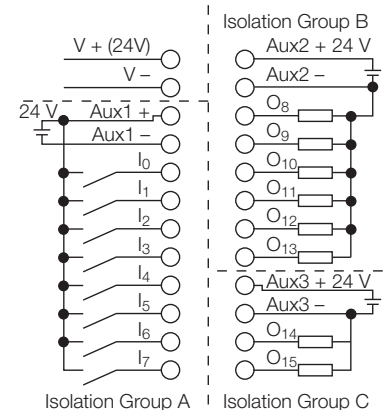

**Fieldbus I/O module for PROFIBUS-DP**  
**16 digital inputs**  
**FDP20-16S**

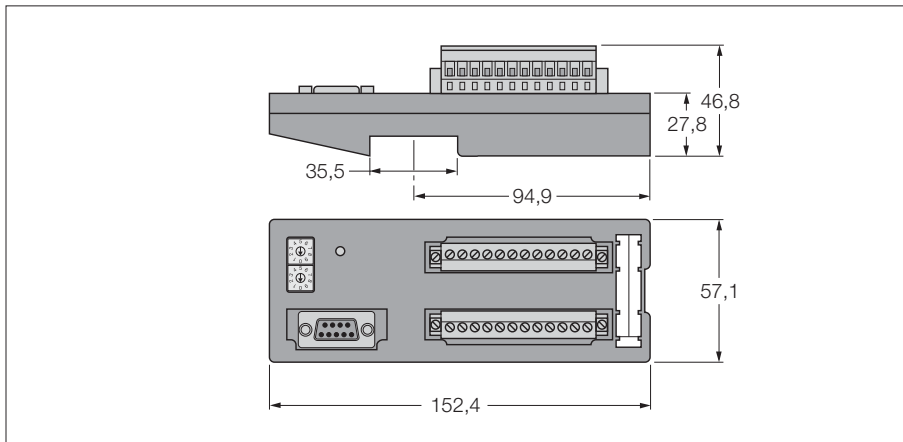

- Rotary coding switch for adjustment of the node address
- Degree of protection IP20
- 3 I/O power supply groups each galvanically isolated
- 16 digital inputs, 24 VDC
- pnp

<b>Type</b>	FDP20-16S
Ident-No.	6611465
<b>Number of channels</b>	16
Electrical isolation	I/Os to PROFIBUS
Internal power consumption	< 75 mA plus I/O supply
Admissible range field supply	18...30VDC
Electrical isolation	I/Os to PROFIBUS
<b>Fieldbus transmission rate</b>	9.6 kbps up to 12 Mbps
Fieldbus addressing range	1...99
Fieldbus addressing	2 decimally coded rotary switches
<b>Inputs</b>	
Input voltage	18...30VDC
Low level signal voltage	< 4 V
High level signal voltage	8...24 V
Low level signal current	< 0.5 mA
High level signal current	1...3.4 mA
Input delay	2,5 ms
Max. input current	700 mA
<b>Operating temperature</b>	0°C...55°C

**Fieldbus**

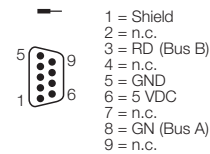

**Wiring diagram**

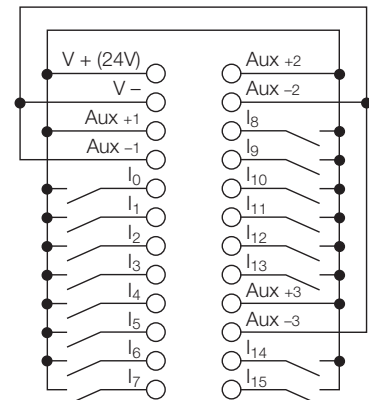

**Wiring diagram**

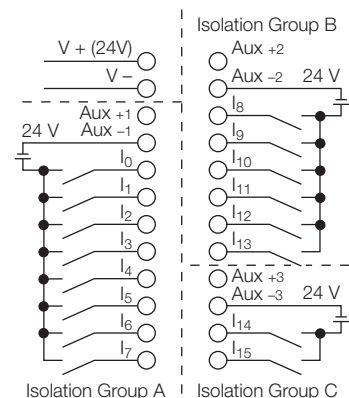

# Fieldbus I/O module for DeviceNet

## 4 digital inputs, 4 configurable channels

### FDN20-4S-4XSG-E

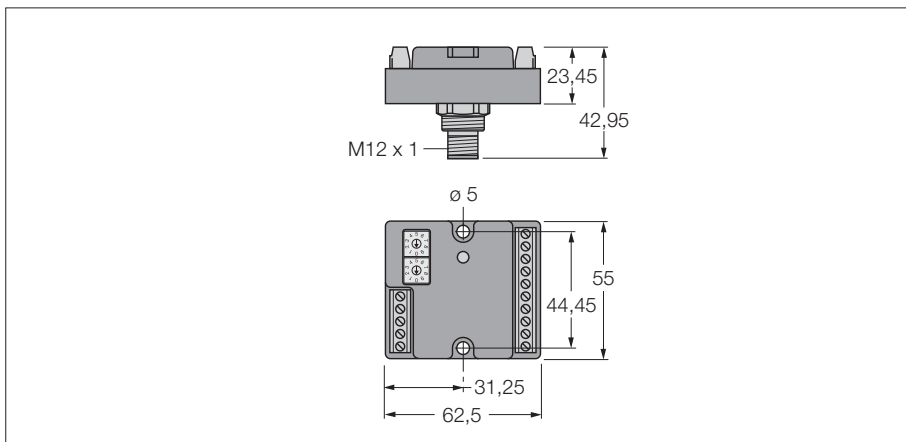

- Rotary coding switch for adjustment of the node address
- Degree of protection IP20
- M12 flange connector for convenient mounting and connection to DeviceNet
- 4 digital inputs
- 4 configurable channels, DI or DO
- 24 VDC
- pnp
- Output current: 0.5 A

<b>Type</b>	FDN20-4S-4XSG-E
Ident-No.	6611343
<b>Number of channels</b>	8
Internal power consumption	< 50 mA plus I/O supply
Voltage supply via DeviceNet	24 VDC
Admissible range field supply	11...26 VDC
<b>Fieldbus transmission rate</b>	125 kbps to 500 kbps
Fieldbus addressing range	0...63
Fieldbus addressing	2 decimally coded rotary switches
<b>Inputs</b>	
Input voltage	11...26 VDC
Low level signal voltage	< 4 V
High level signal voltage	8...24 V
Low level signal current	< 0.5 mA
High level signal current	1...3.4 mA
Input delay	2.5 ms
Max. input current	total: 700 mA
<b>Outputs</b>	
Output voltage	18...26 VDC, short-circuit proof
Output current per channel	0.5 A (from DeviceNet)
Switching frequency	≤ 100 Hz
<b>Operating temperature</b>	-40°C...70°C

#### Fieldbus

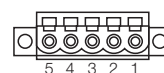

- 1 = BK (V -)
- 2 = BU (CAN L)
- 3 = Shield
- 4 = WH (CAN H)
- 5 = RD (V +)

#### Wiring diagram

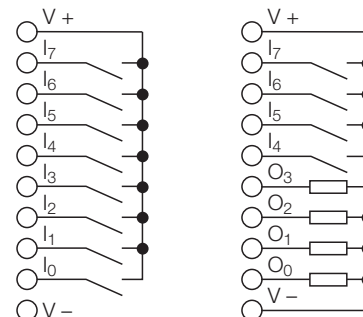

#### Fieldbus

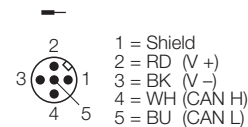

- 1 = Shield
- 2 = RD (V +)
- 3 = BK (V -)
- 4 = WH (CAN H)
- 5 = BU (CAN L)



**Fieldbus I/O module for DeviceNet**  
**4 digital inputs, 4 configurable channels**  
**FDN20-4S-4XSG**

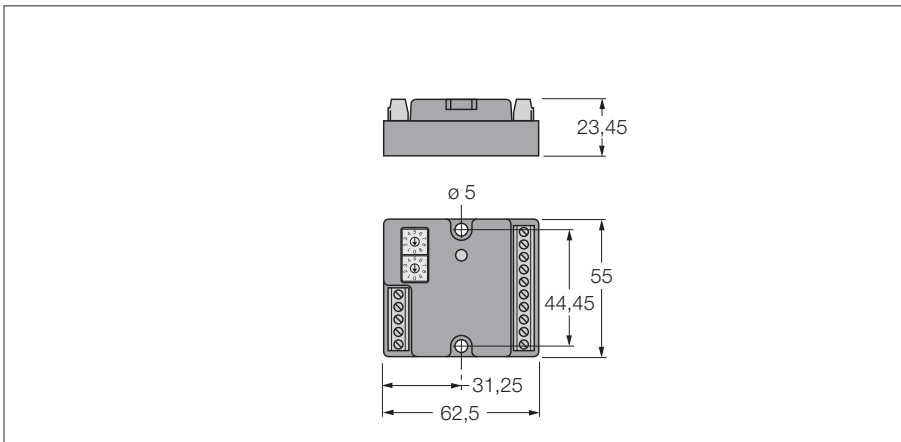

- Rotary coding switch for adjustment of the node address
- Degree of protection IP20
- 4 digital inputs
- 4 configurable channels, DI or DO
- 24 VDC
- pnp
- Output current: 0.5 A

<b>Type</b>	FDN20-4S-4XSG
Ident-No.	6611359
<b>Number of channels</b>	8
Internal power consumption	< 50 mA plus I/O supply
Voltage supply via DeviceNet	24 VDC
Admissible range field supply	11...26 VDC
<b>Fieldbus transmission rate</b>	125 kbps to 500 kbps
Fieldbus addressing range	0...63
Fieldbus addressing	2 decimally coded rotary switches
<b>Inputs</b>	
Input voltage	11...26 VDC
Low level signal voltage	< 4 V
High level signal voltage	8...24 V
Low level signal current	< 0.5 mA
High level signal current	1...3.4 mA
Input delay	2.5 ms
Max. input current	total:: 700 mA
<b>Outputs</b>	
Output voltage	18...26 VDC, short-circuit proof
Output current per channel	0.5 A (from DeviceNet)
Switching frequency	≤ 100 Hz
<b>Operating temperature</b>	-40°C...70°C

**Fieldbus**

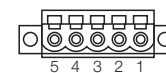

- 1 = BK (V -)
- 2 = BU (CAN L)
- 3 = Shield
- 4 = WH (CAN H)
- 5 = RD (V +)

**Wiring diagram**

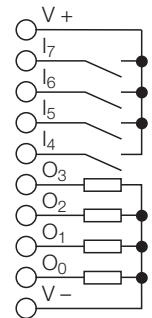
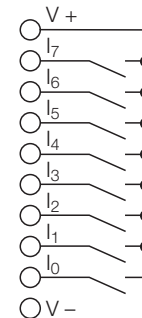

# Fieldbus I/O module for DeviceNet

## 4 digital inputs, 4 configurable channels

### FDN20-4S-4XSG-DIN

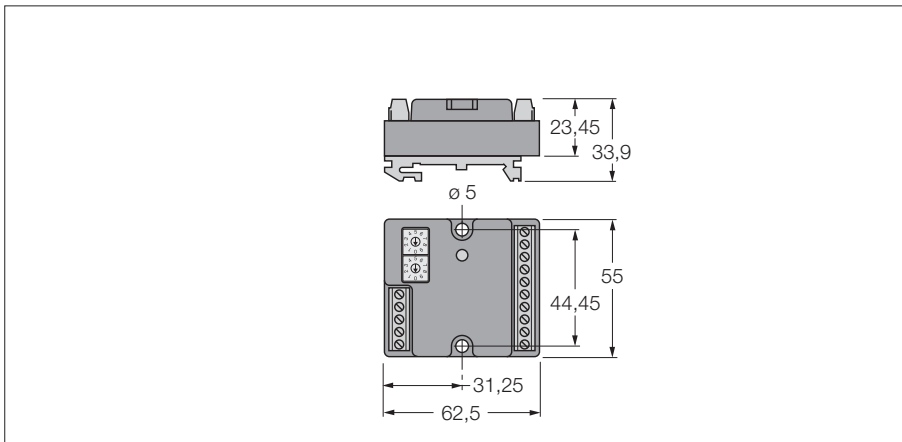

- Rotary coding switch for adjustment of the node address
- Degree of protection IP20
- Can be mounted on DIN rail
- 4 digital inputs
- 4 configurable channels, DI or DO
- 24 VDC
- pnp
- Output current: 0.5 A

<b>Type</b>	FDN20-4S-4XSG-DIN
Ident-No.	6611377
<b>Number of channels</b>	8
Internal power consumption	< 50 mA plus I/O supply
Voltage supply via DeviceNet	24 VDC
Admissible range field supply	11...26 VDC
<b>Fieldbus transmission rate</b>	125 kbps to 500 kbps
Fieldbus addressing range	0...63
Fieldbus addressing	2 decimally coded rotary switches
<b>Inputs</b>	
Input voltage	11...26 VDC
Low level signal voltage	< 4 V
High level signal voltage	8...24 V
Low level signal current	< 0.5 mA
High level signal current	1...3.4 mA
Input delay	2.5 ms
Max. input current	total: 700 mA
<b>Outputs</b>	
Output voltage	18...26 VDC, short-circuit proof
Output current per channel	0.5 A (from DeviceNet)
Switching frequency	≤ 100 Hz
<b>Operating temperature</b>	-40°C...70°C

#### Fieldbus

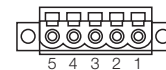

- 1 = BK (V -)
- 2 = BU (CAN L)
- 3 = Shield
- 4 = WH (CAN H)
- 5 = RD (V +)

#### Wiring diagram

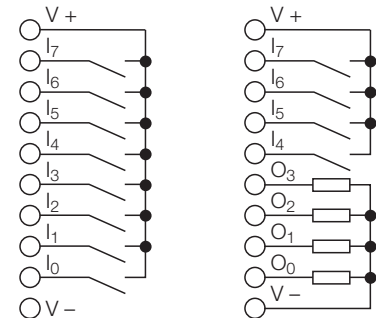

**Fieldbus I/O module for DeviceNet**  
**16 configurable channels**  
**FDN20-16XSG**

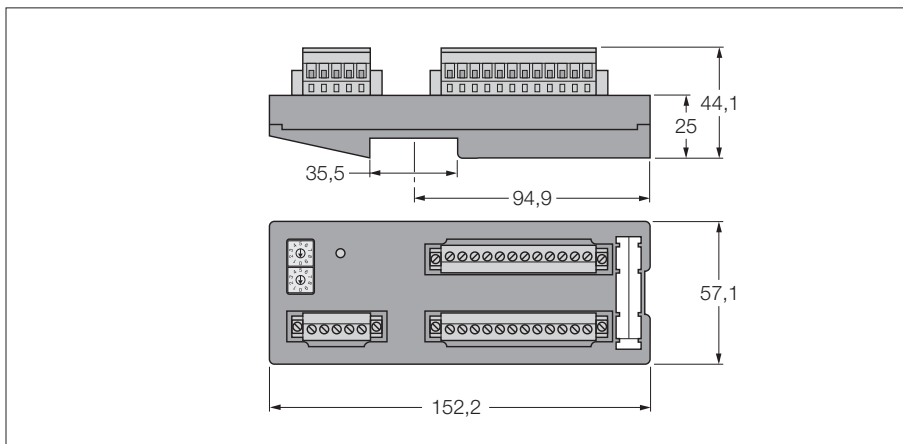

- Rotary coding switch for adjustment of the node address
- Degree of protection IP20
- 3 I/O power supply groups each galvanically isolated
- 16 configurable channels, DI or DO
- 24 VDC
- pnp
- Output current: 0.5 A

<b>Type</b>	FDN20-16XSG
<b>Ident-No.</b>	6611373
<b>Number of channels</b>	16
Electrical isolation	I/Os to DeviceNet
Internal power consumption	< 75 mA plus I/O supply
Voltage supply via DeviceNet	24 VDC
Admissible range field supply	11...26 VDC
Electrical isolation	I/Os to DeviceNet
<b>Fieldbus transmission rate</b>	125 kbps to 500 kbps
Fieldbus addressing range	0...63
Fieldbus addressing	2 decimally coded rotary switches
<b>Inputs</b>	
Input voltage	11...26 VDC
Low level signal voltage	< 4 V
High level signal voltage	8...24 V
Low level signal current	< 0.5 mA
High level signal current	1...3.4 mA
Input delay	1 ms
Max. input current	total: 700 mA
<b>Outputs</b>	
Output voltage	18...26 VDC, short-circuit proof
Output current per channel	0.5A (from Aux)
Switching frequency	≤ 100 Hz
<b>Operating temperature</b>	-40°C...70°C

**Fieldbus**

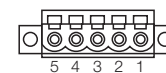

- 1 = BK (V -)
- 2 = BU (CAN L)
- 3 = Shield
- 4 = WH (CAN H)
- 5 = RD (V +)

**Wiring diagram**

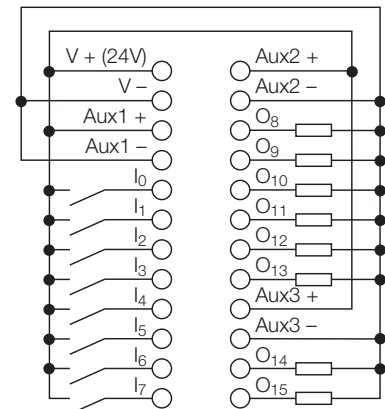

**Wiring diagram**

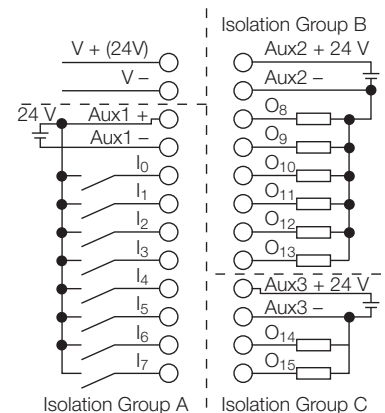

# Fieldbus I/O module for DeviceNet

## 16 digital inputs

### FDN20-16S

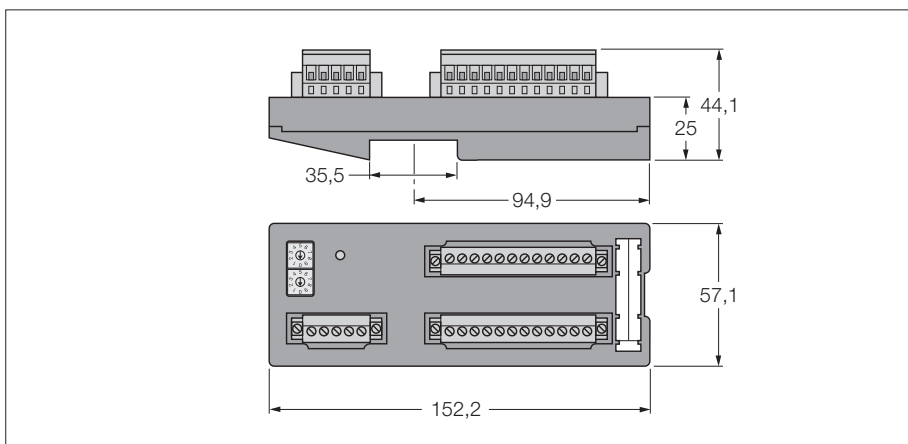

- Rotary coding switch for adjustment of the node address
- Degree of protection IP20
- 3 I/O power supply groups each galvanically isolated
- 16 digital inputs, 24 VDC
- pnp

<b>Type</b>	FDN20-16S
Ident-No.	6611312
<b>Number of channels</b>	16
Electrical isolation	I/Os to DeviceNet
Internal power consumption	< 75 mA plus I/O supply
Voltage supply via DeviceNet	24 VDC
Admissible range field supply	11...26 VDC
Electrical isolation	I/Os to DeviceNet
<b>Fieldbus transmission rate</b>	125 kbps to 500 kbps
Fieldbus addressing range	0...63
Fieldbus addressing	2 decimally coded rotary switches
<b>Inputs</b>	
Input voltage	11...26 VDC
Low level signal voltage	< 4 V
High level signal voltage	8...24 V
Low level signal current	< 0.5 mA
High level signal current	1...3.4 mA
Input delay	1 ms
Max. input current	total: 700 mA
<b>Operating temperature</b>	-40°C...70°C

#### Fieldbus

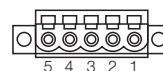

- 1 = BK (V -)
- 2 = BU (CAN L)
- 3 = Shield
- 4 = WH (CAN H)
- 5 = RD (V +)

#### Wiring diagram

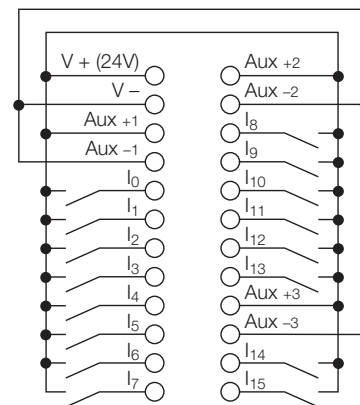

#### Wiring diagram

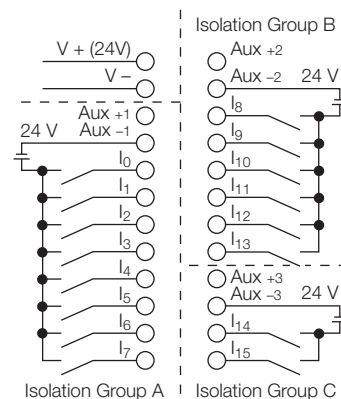



**DIGITAL**  
**ANALOGUE**  
**TECHNOLOGY**  
**RFID**

  
**EtherNet/IP™**

**PROFI**  
INDUSTRIAL ETHERNET  
**NET**

**CANopen**

**PROFI**  
PROCESS FIELD BUS  
**BUS**

  
**DeviceNet™**

**Modbus TCP**

# BL20 – Modular fieldbus I/O System in IP20

**TURCK**

Industrial  
Automation



<b>BL20 – General</b>	<b>Page</b>
BL20 – System concept	328
BL20 – CoDeSys and I/O-ASSISTANT	330
BL20 – Electronic modules – module code and colour code	332
BL20 – Base modules – type code	333
BL20 – Combination options	334
BL20 – System supply and power supply concept	336
BL20 – Maximum system expansion and power supply	338
BL20 – General technical data	340
BL20 – Special accessories	342

<b>BL20 – Gateways</b>	
Gateways for PROFIBUS-DP	346
Gateway for DeviceNet™	348
Gateways for CANopen	349
Gateway for MODBUS TCP	351
Gateway for EtherNet/IP	352

<b>BL20 – Programmable Gateways</b>	
Programmable gateway for MODBUS TCP	353
Programmable gateway for EtherNet/IP	354

<b>BL20 – Electronic modules and related base modules</b>	
Bus refreshing modules	356
Power feeding modules	358
Digital input modules	362
Analogue input modules	382
Digital output modules	396
Analogue output modules	420
Counter module	426
RS232 interface	428
RS485/422 interface	430
SSI interface	432
BL ident® RFID modules	434
SWIRE communication modules	438

<b>BL20 – Motor starter</b>	
BL20 motor starter – System concept	440
BL20 motor starter – Selection guide direct starter	442
BL20 motor starter – Selection guide reversing starter	444
BL20 motor starter – Technical specification motor protection switches	446
BL20 motor starter – Technical specification power contactors	447
BL20 motor starter – Accessories	448

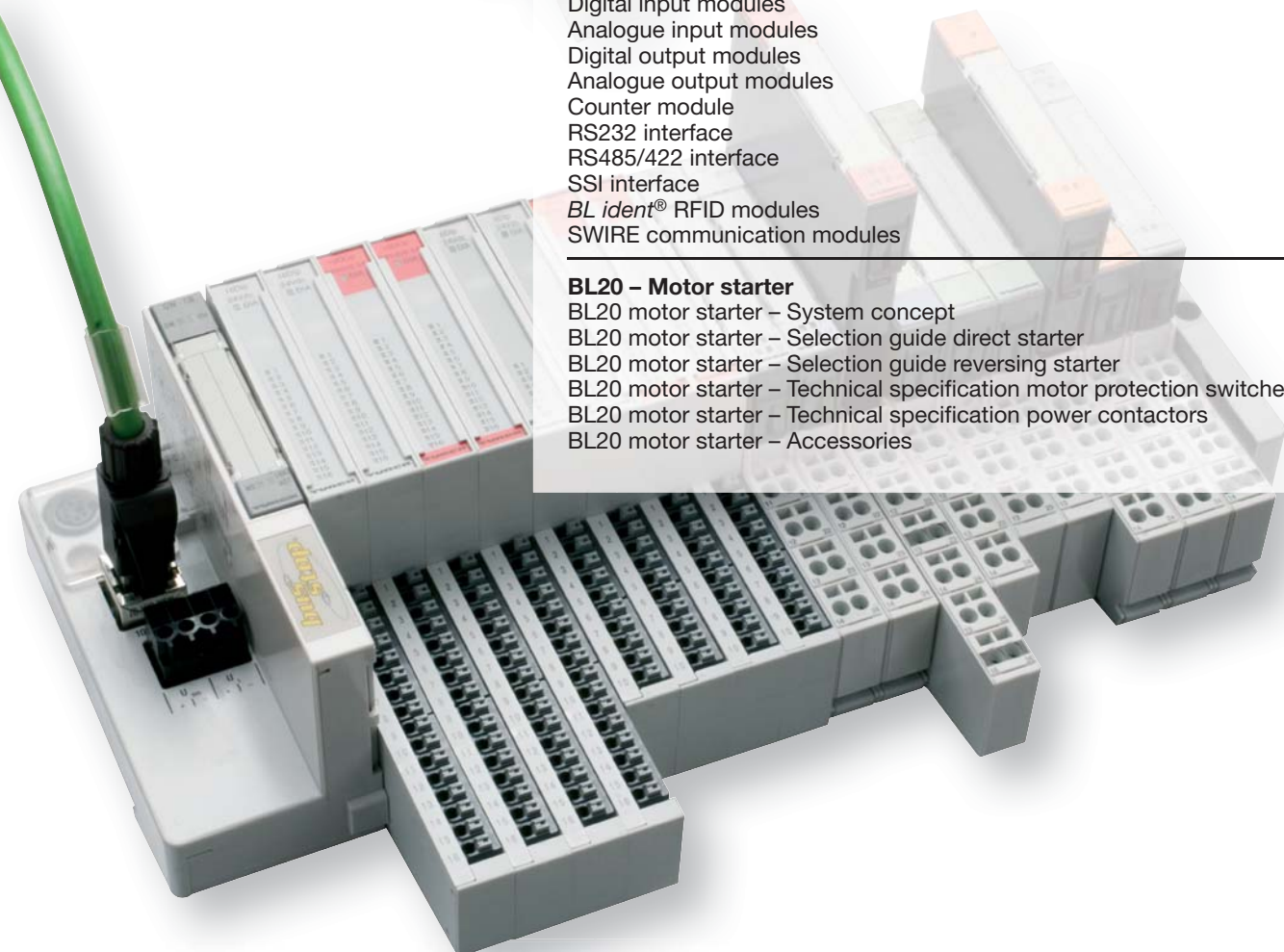

# The BL20 I/O system – The integrator for fieldbus, ident system, motor starter

## Gateway – The system control

- The interface to the higher level control system
- Gateways e.g. for PROFIBUS-DP, CANopen, DeviceNet™, Ethernet/IP and Modbus TCP – also available as economy version



## Optional – CoDeSys programmable according to IEC 61131

- Relieves higher-level controller and bus system
- I/O modules independent of the fieldbus
- Prefabricated function blocks e.g. for the RFID system *BL ident*®

## Economy I/O – extremely compact and competitively priced

- 8 or 16 I/Os in only 12,5 mm
- Integrated connection level with „Push-in“ tension spring technology, no tools necessary
- Economy I/Os combinable with standard I/O slices

## *BL ident*®, the RFID system

- Up to 8 RFID channels
- Pre-processing in programmable gateway relieves the higher-level controller.

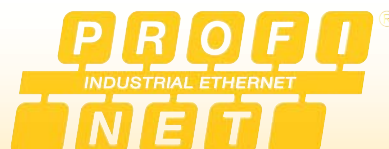
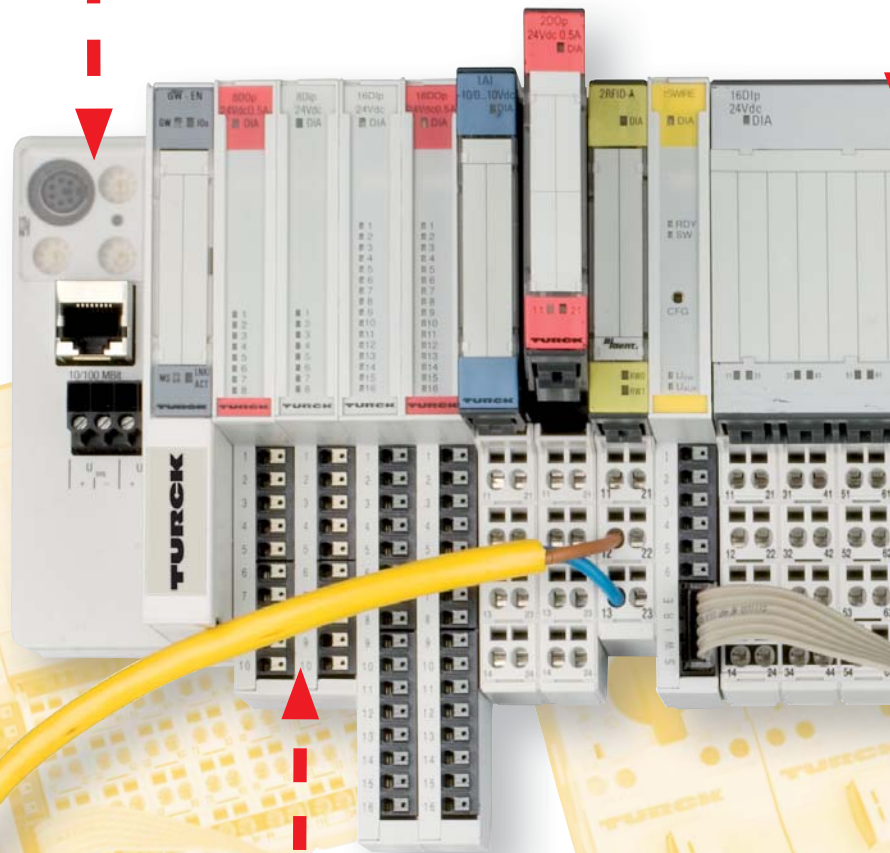

Modbus TCP



**Standard I/O – multifunctional and system friendly**

- Exchangeable electronic modules – disconnection of field wiring is not necessary.
- Up to two neighbouring modules are exchangeable during normal system operation without disrupting system functions
- Single or block modules with screw or cage clamp terminals



**I/O-ASSISTANT**

- Planning, configuration, commissioning and diagnostic software
- Based on FDT/DTM technology
- Available as freeware on [www.turck.com](http://www.turck.com)

**Motor starter**

- 3 connection-slices per gateway
- Up to 16 devices per slice
- Simple wiring

**CANopen**

**PROFI**  
PROCESS FIELD BUS  
**BUS**

**DeviceNet™**

## Easy programming with CoDeSys according to IEC 61131-3

The programmable gateways become decentral control units with the CoDeSys programming software. The graphical programming interface supports all IEC-61131-3 programming languages

- Statement list ( STL)
- Ladder Diagram (LD)
- Continuous Function Chart (CFC)
- Structured Text (ST)
- Sequential Function Chart (AS)



## Simple connection

- Fast and simple networking of heterogeneous systems
- Standard transmission protocols such as TCP/IP and UDP/IP
- Global network variables
- Bidirectional data exchange between CoDeSys systems
- No additional programming required

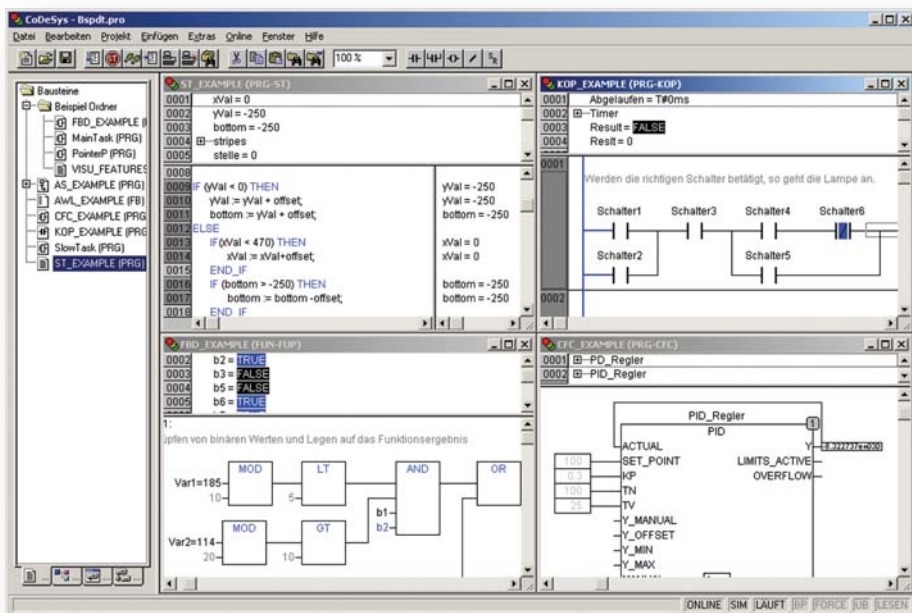

**Data-exchange via Ethernet**

## Project planning and configuration

- Target Support Package as a driver for the target system
- Drag and Drop function for hardware configuration
- Standard editor for I/O configuration and parameterisation
- Symbolic display of variables for I/O addresses
- Numerous diagnostics and commissioning functions
- Function blocks e. g. for the RFID system *BL ident<sup>®</sup>*

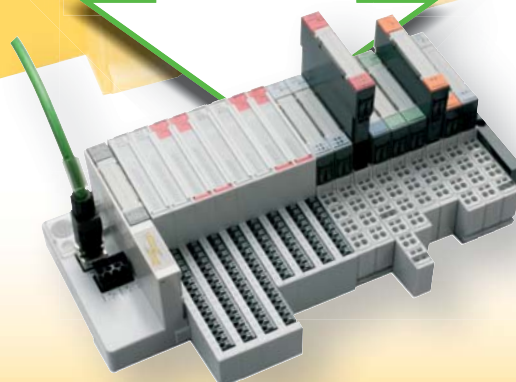

## Easy parameterisation with the I/O-ASSISTANT on the basis of FDT/DTM technology

- System configuration, parameterisation and diagnostics with a graphical interface based on FDT/DTM technology
- DTMs can be integrated in any FDT frame application for configuration, commissioning and maintenance
- I/O-ASSISTANT and DTMs are available as freeware on [www.turck.com](http://www.turck.com)

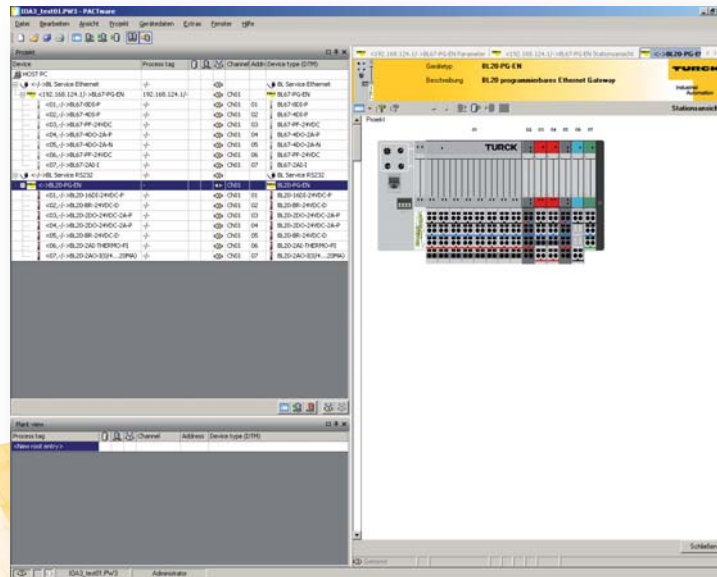

### Description

The configuration software I/O-ASSISTANT supports you in planning and implementation of your I/O system. No matter if you are online or offline, the I/O-ASSISTANT simplifies configuration and parameterisation of the modules.

This software is also extremely helpful in system set-up and testing.

### Functions

- Supporting software tool
- Selection of the required modules
- Offline planning and configuration of BL20 modules
- Configuration, parameterisation and commissioning of individual modules
- Reading and setting of process data
- Commissioning help for testing the wiring and sensors without PLC
- Realistic display of configured BL20 components
- Automatic documentation of configured BL20 systems













# BL20 Electronic modules – Type code and colour code

## Electronic module – Type code

Marking	Designation	Examples
<b>GWBR</b>	Gateway with integrated supply	BL20- <b>GWBR</b> -PBDP
<b>PBDP</b>	PROFIBUS-DP	BL20-GWBR- <b>PBDP</b>
<b>E</b>	ECONOMY modules	BL20- <b>E</b> -8DI-24VDC-P
<b>BL20-8/-E-8</b>	Number of channels	BL20-E- <b>8</b> DI-24VDC-P
<b>BR</b>	Bus refreshing modules	BL20- <b>BR</b> -24VDC-D
<b>PF, D</b>	Power feeding modules, with diagnostics	BL20- <b>PF</b> -24VDC-D
<b>DI</b>	Digital input module	BL20-2 <b>DI</b> -24VDC-P
<b>N</b>	npn	BL20-2DI-24VDC- <b>N</b>
<b>P</b>	pnp	BL20-2DI-24VDC- <b>P</b>
<b>DO</b>	Digital output module	BL20-2 <b>DO</b> -24VDC-2A-P
<b>R</b>	Relay module	BL20-2DO- <b>R</b> -NC
<b>CO</b>	Change over	BL20-2DO-R- <b>CO</b>
<b>NC</b>	Normally closed	BL20-2DO-R- <b>NC</b>
<b>NO</b>	Normally open	BL20-2DO-R- <b>NO</b>
<b>AI</b>	Analogue input module	BL20-1 <b>AI</b> -U(-10/0...+10VDC)
<b>PT/NI</b>	Analogue input module for the connection of resistance thermometers Ni100 and Ni1000 as well as Pt100, Pt500 and Pt1000 in 2-wire and 3-wire technology	BL20-2AI- <b>PT/NI</b> -2/3
<b>PI</b>	Analogue input module for the connection of thermocouples with cold junction compensation	BL20-2AI-THERMO- <b>PI</b>
<b>AO</b>	Analogue output module	BL20-1 <b>AO</b> -I(0/4...20MA)
<b>CNT</b>	Counter module	BL20-1 <b>CNT</b> -24VDC

## Electronic modules – Colour code

Electronic module	Colour code
Gateway	 dusty grey
Bus refreshing modules 24 VDC	 dusty grey
Power feeding modules 24 VDC	 dusty grey
Power feeding modules 120/230 VAC	 orange brown
Digital input modules	 light grey
Analogue input modules	 pigeon blue
Digital output modules	 strawberry red
Analogue output modules	 pale green
Relay modules	 pastel orange
Technology modules (counter module)	 zinc yellow

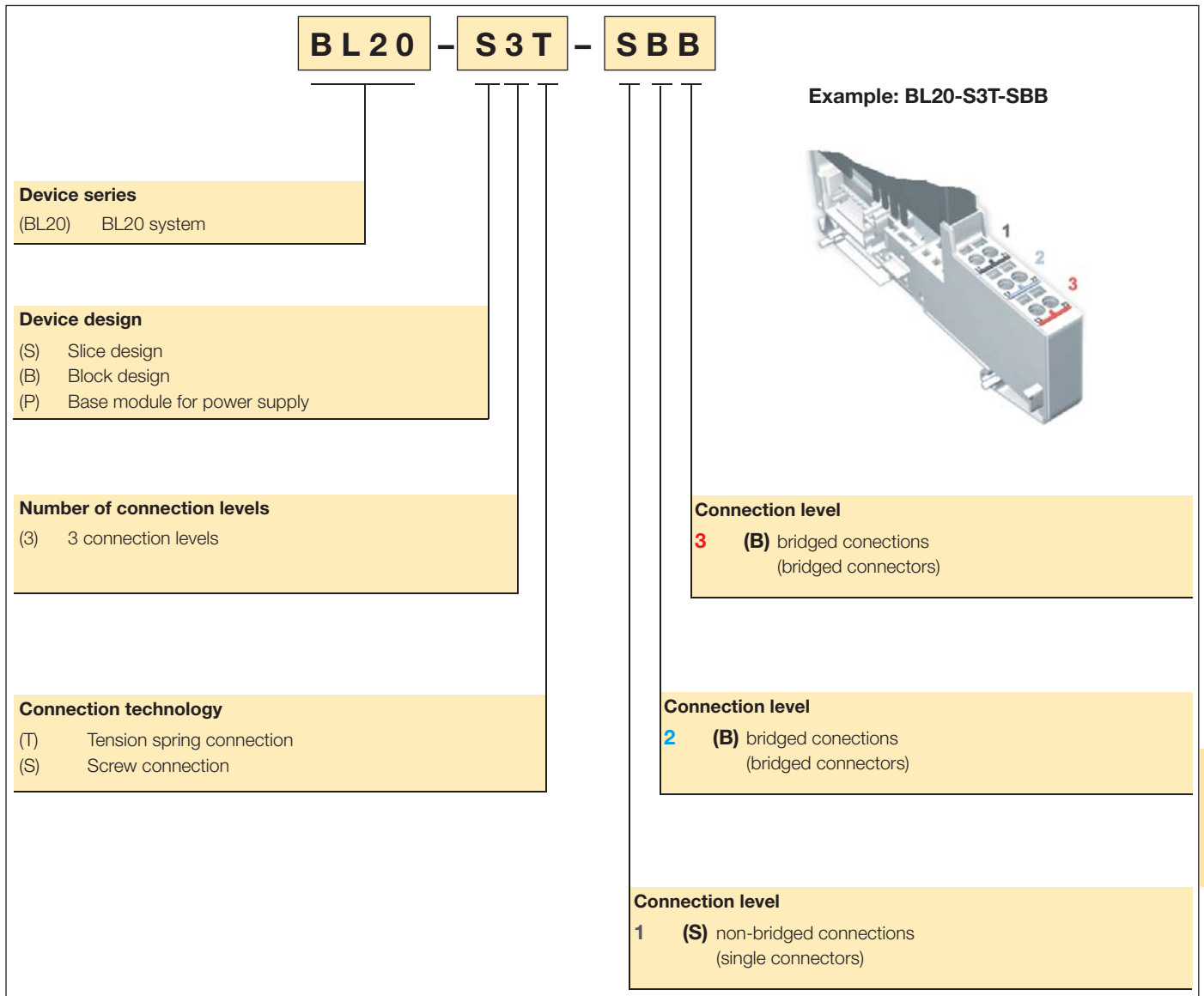

# BL20 - Combination options

## Electronic modules and base modules

		Base modules with tension spring connection																	
		BL20-S3T-SBB	BL20-S3T-SBC	BL20-S4T-SBBC	BL20-S4T-SBBS	BL20-S4T-SBCS	BL20-S4T-SBBS-CJ	BL20-S6T-SBBSBB	BL20-S6T-SBCSBC	BL20-B3T-SBB	BL20-B3T-SBC	BL20-B4T-SBBC	BL20-B6T-SBBSBB	BL20-B6T-SBCSBC	BL20-P3T-SBB	BL20-P3T-SBB-B	BL20-P4T-SBBC	BL20-P4T-SBBC-B	Page
<b>Digital input modules</b>																			
BL20-2DI-24VDC-P	6827009	✓	✓																362
BL20-2DI-24VDC-N	6827010	✓	✓																364
BL20-2DI-120/230VAC-P	6827011	✓	✓																366
BL20-4DI-24VDC-P	6827012			✓	✓														368
BL20-4DI-24VDC-N	6827013			✓	✓			✓											370
BL20-4DI-NAMUR	6827212			✓	✓														372
BL20-16DI-24VDC-P	6827014								✓			✓							376
BL20-32DI-24VDC-P	6827015												✓						380
<b>Analogue input modules</b>																			
BL20-1AI-I(0/4...20MA)	6827018	✓	✓																382
BL20-2AI-I(0/4...20MA)	6827021	✓	✓	✓	✓														386
BL20-1AI-U(-10/0...+10VDC)	6827019	✓	✓	✓	✓														384
BL20-2AI-U(-10/0...+10VDC)	6827022	✓	✓	✓	✓														388
BL20-2AI-PT/NI-2/3	6827017	✓		✓															390
BL20-2AI-THERMO-PI	6827020					✓													392
BL20-4AI-U/I	6827217								✓										394
<b>Digital output modules</b>																			
BL20-2DO-24VDC-0,5A-P	6827024		✓	✓															396
BL20-2DO-24VDC-0,5A-N	6827025		✓	✓															398
BL20-2DO-24VDC-2A-P	6827026		✓	✓	✓	✓													400
BL20-2DO-120/230VAC-0.5A	6827137		✓	✓	✓	✓													402
BL20-4DO-24VDC-0,5A-P	6827023				✓	✓		✓											410
BL20-16DO-24VDC-0,5A-P	6827027										✓								414
BL20-32DO-24VDC-0,5A-P	6827220												✓						418
<b>Analogue output modules</b>																			
BL20-1AO-I(0/4...20MA)	6827032	✓	✓																420
BL20-2AO-I(0/4...20MA)	6827034	✓	✓																422
BL20-2AO-U(-10/0...+10VDC)	6827033	✓																	424
<b>Relay modules</b>																			
BL20-2DO-R-NC	6827028				✓	✓													406
BL20-2DO-R-NO	6827029				✓	✓													404
BL20-2DO-R-CO	6827030				✓	✓													408
<b>Technology modules</b>																			
BL20-1CNT-24VDC	6827031																		426
BL20-1RS232	6827169				✓														428
BL20-1RS485/422	6827165				✓														430
BL20-1SSI	6827166				✓														432
<b>Power supply modules</b>																			
BL20-BR-24VDC-D	6827006														1	2	1	2	356
BL20-PF-24VDC-D	6827007														✓	✓	✓	✓	358
BL20-PF-120/230VAC-D	6827008														✓		✓		360
<b>BL ident<sup>®</sup> RFID modules</b>																			
BL20-2RFID-A	6827233																		434
BL20-2RFID-C	6827239				✓														436

<sup>1</sup> Base module with gateway power supply

<sup>2</sup> Base module for module refresh within the station

Base modules with screw connections	Ident.-no.	Page
	BL20-S3S-SBB	6827045
	BL20-S3S-SBC	6827059
	BL20-S4S-SBBC	6827051
	BL20-S4S-SBBS	6827047
	BL20-S4S-SBCS	6827060
	BL20-S6S-SBBS-CJ	6827049
	BL20-S6S-SBBSBB	6827053
	BL20-B3S-SBCSBC	6827066
	BL20-B3S-SBB	6827055
	BL20-B4S-SBBC	6827062
	BL20-B6S-SBBSBB	6827057
	BL20-B6S-SBCSBC	6827067
	BL20-P3S-SBB	6827219
	BL20-P3S-SBB-B	6827037
	BL20-P4S-SBBC	6827041
	BL20-P4S-SBBC-B	6827039
		6827043
		362
		364
		366
		368
		370
		372
		376
		380
		382
		386
		384
		388
		390
		392
		394
		396
		398
		400
		402
		410
		414
		418
		420
		422
		424
		406
		404
		408
		426
		428
		430
		432
		356
		358
		360
		434
		436

### ECONOMY modules

Digital input modules – series ECO (base module integrated)		Page
BL20-E-8DI-24VDC-P	6827227	374
BL20-E-16DI-24VDC-P <sup>3</sup>	6827231	378
Digital output modules – series ECO (base module integrated)		Page
BL20-E-8DO-24VDC-0,5A-P	6827226	412
BL20-E-16DO-24VDC-0,5A-P	6827230	416
SWIRE communication module – series ECO (base module integrated)		Page
BL20-E-1SWIRE	6827251	438

# BL20 – System supply

## General system power supply

The BL20 system features two power circuits:

- The internal module bus feeds the module electronics and the gateway.
- The field supply feeds all connected fieldbus devices.

## Forming potential groups

Bus-Refreshing modules as well as Power-Feeding modules can be used for the creation of potential groups.

Modules with 24 VDC and 120/230 VAC field supply should not be used in the same potential group.

The use of digital input modules for 120/230 VAC requires the creation of a separate potential group with the Power-Feeding module BL20-PF-120/230VAC-D.

## Module bus supply

The voltage supply for the module bus is integrated in current BL20 gateways. If the module bus is not sufficiently supplied (max. 1.5 A), a second Refreshing-Module has to be applied – see chapter **Supply concept** on the next page .

**NOTE:** Bus-Refreshing modules can not be used in combination with the Economy gateway for PROFIBUS-DP.

## Rated current consumption

The following table shows the rated current consumption of the different BL20 modules on the module bus.

## Field supply

The field supply is provided by the gateway.

A Power-Feeding module has to be used if the field supply of fieldbus nodes reaches 10 A or a new potential group is required (see section to the left).

## System planning

For the planning of many complex BL20 stations, different factors have to be considered. For example rated current consumption of the modules, number of modules, parameters and data volume and possible restrictions imposed by the higher level fieldbus.

The I/O-ASSISTANT (p.331), which can be downloaded from our website checks all relevant parameters and simplifies project planning considerably.

The I/O-ASSISTANT is also able to generate dimension drawings and documentation of the stations. Reading and setting of I/Os is also possible which proves very helpful for commissioning. Furthermore, module parameters can be set.

Module	Supply $I_{MB}^1$	Rated current consumption $I_{MB}^1$
Gateway PROFIBUS-DP		430 mA
Gateway DeviceNet™		250 mA
Gateway CANOPEN		350 mA
BL20-BR-24VDC-D	1500 mA	
BL20-PF-24VDC-D		28 mA
BL20-PF-120/230VAC-D		25 mA
BL20-2DI-24VDC-P		28 mA
BL20-2DI-24VDC-N		28 mA
BL20-2DI-120/230VAC-P		28 mA
BL20-4DI-24VDC-P		28 mA
BL20-4DI-24VDC-N		28 mA
BL20-4DI-NAMUR		40 mA
BL20-E-8DI-24VDC-P		30 mA
BL20-16DI-24VDC-P		45 mA
BL20-32DI-24VDC-P		45 mA
BL20-1AI-I(0/4..20mA)		41 mA
BL20-2AI-I(0/4..20mA)		35 mA
BL20-1AI-U (-10/0..+10VDC)		41 mA
BL20-2AI-U (-10/0..+10VDC)		35 mA
BL20-2AI-PT/Ni-2/3		45 mA
BL20-2AI-THERMO-PI		45 mA
BL20-4AI-U/I		50 mA
BL20-2DO-24VDC-0,5A-P		32 mA
BL20-2DO-24VDC-0,5A-N		32 mA
BL20-2DO-24VDC-2A-P		33 mA
BL20-2DO-120/230VAC-0,5A		35 mA
BL20-4DO-24VDC-0,5A-P		30 mA
BL20-E-8DO-24VDC-0,5-P		30 mA
BL20-16DO-24VDC-0,5-P		120 mA
BL20-32DO-24VDC-0,5-P		120 mA
BL20-1AO-I(0/4..20mA)		39 mA
BL20-2AO-I(0/4..20mA)		40 mA
BL20-2AO-U (-10/0..+10VDC)		43 mA
BL20-2DO-R-NC		28 mA
BL20-2DO-R-NO		28 mA
BL20-2DO-R-CO		28 mA
BL20-1CNT-24VDC		40 mA
BL20-1RS232		140 mA
BL20-1RS485/422		140 mA
BL20-1SSI		50 mA

<sup>1</sup>  $I_{MB}$  : current via the module bus

<sup>2</sup>  $I_{EI}$  : electrical operating current (field supply)

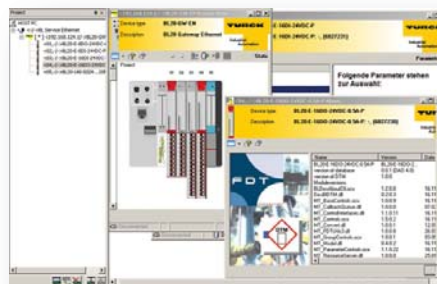



## Standard gateways (with integrated power supply)

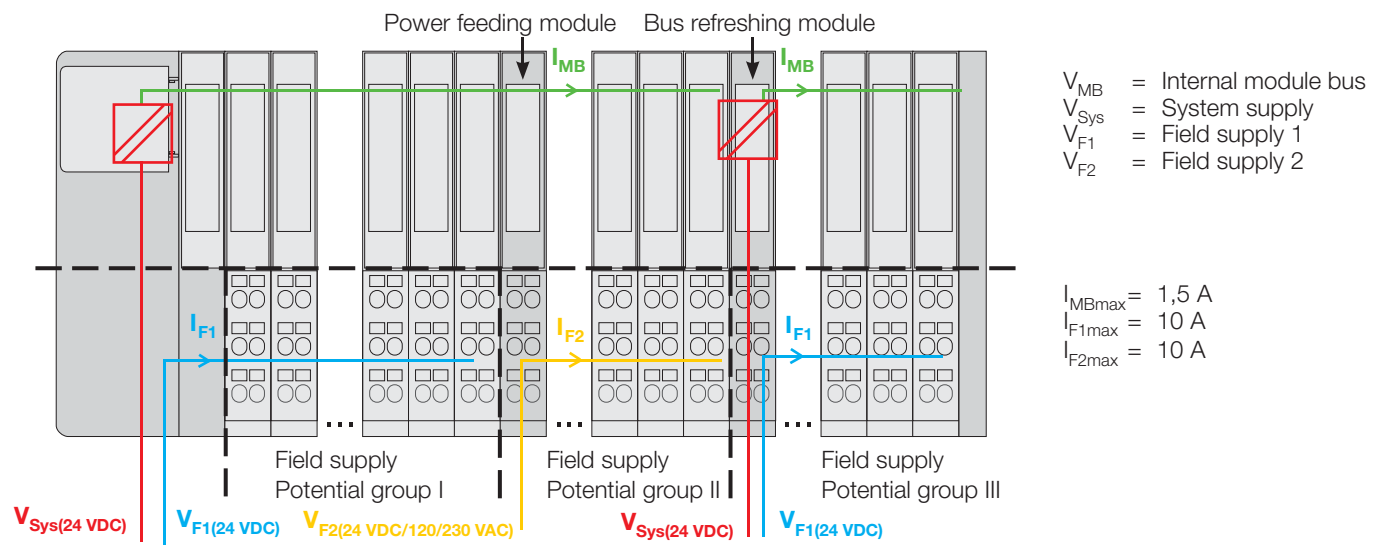

## Economy gateway for PROFIBUS-DP (with integrated power supply)

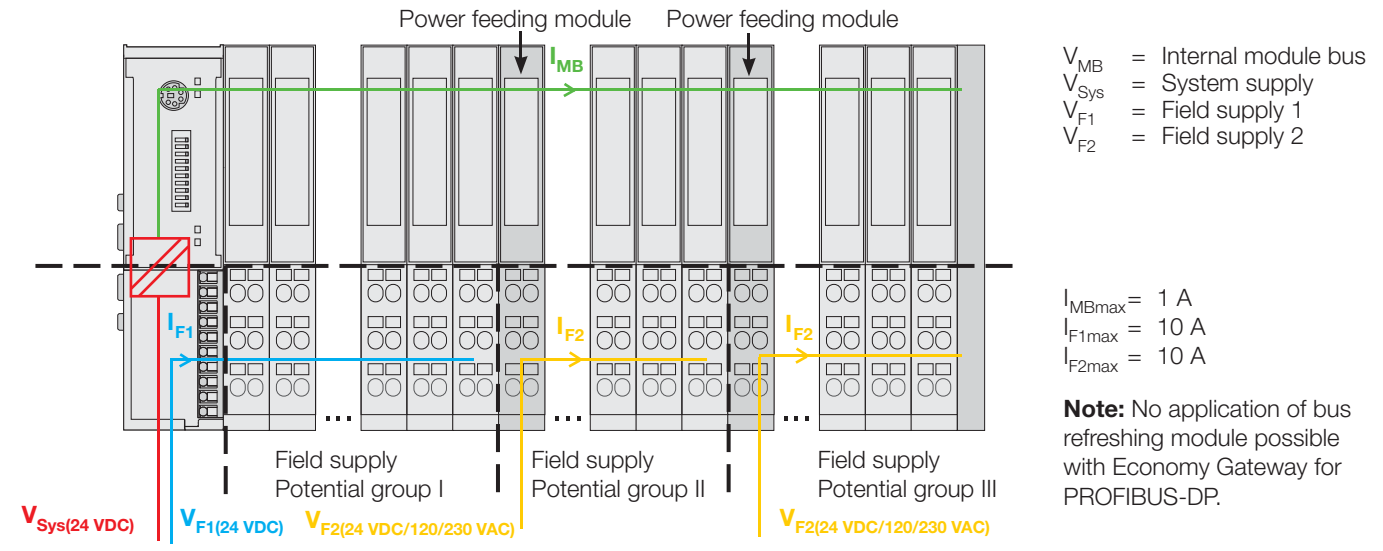

## Economy gateway for CANopen (with integrated power supply)

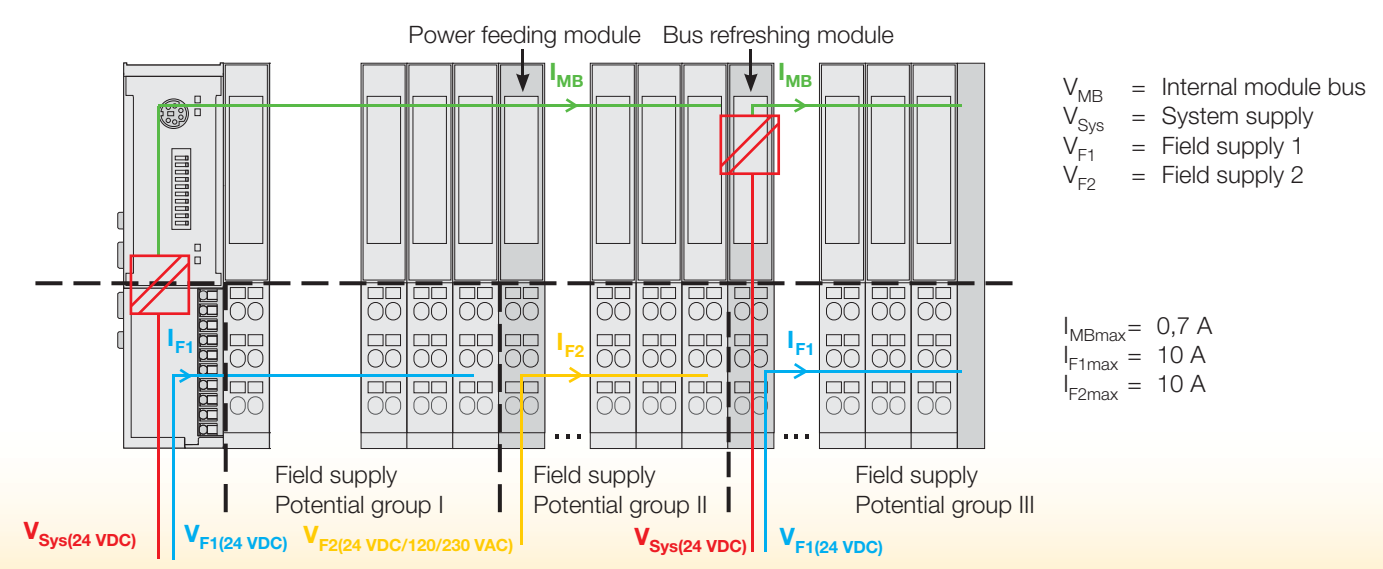

# BL20 – Maximum system extension

## Maximum system extension

The maximum number of modules depends on the respective system configuration. Important thereby is the current consumption of the different I/O

modules (see table rated current consumption, p.336) as well as the required address space and the fieldbus used. The tables below show some of the limitations for different fieldbuses.

The configuration software I/O- ASSISTANT takes these and all other relevant parameters into consideration and generates a warning message if appropriate.

## Standard gateways

Module type	PROFI <sup>®</sup> BUS		DeviceNet		CANopen		Ethernet Modbus TCP		EtherNet/IP <sup>®</sup>	
	Number of chan.	Number of mod.	Number of chan.	Number of mod.	Number of chan.	Number of mod.	Number of chan.	Number of mod.	Number of chan.	Number of mod.
Digital inputs, 4 DI	288	72	288	72	288	72	288	72	288	72
Digital inputs, 4DI NAMUR	112	28	288	72	288	72	288	72	288	72
Digital inputs, 16 DI	128	8	128	8	128	8	128	8	128	8
Digital inputs, 32 DI	256	8	256	8	256	8	256	8	256	8
Digital outputs, 2 DO-R	144	72	144	72	144	72	144	72	144	72
Digital outputs, 4 DO	288	72	288	72	288	72	288	72	288	72
Digital outputs, 16 DO	128	8	128	8	128	8	128	8	128	8
Digital outputs, 32 DO	256	8	256	8	256	8	256	8	256	8
Analogue inputs, 2 AI-I	78	39	126	63	144	72	126	63	126	63
Analogue inputs, 2 AI-U	78	39	126	63	144	72	126	63	126	63
Analogue inputs, 4 AI-U/I	112	28	124	31	288	72	124	31	124	31
Analogue inputs, 2 AI-PT/NI	56	28	126	63	142	71	126	63	126	63
Analogue inputs, 2 AI-THERMO	76	38	126	63	142	71	126	63	126	63
Analogue outputs, 2 AO-I	38	19	126	63	142	71	126	63	126	63
Analogue outputs, 2 AO-U	38	19	126	63	144	72	126	63	126	63
Counter module, 1 CNT	7	7	31	31	71	71	31	31	31	31
Serial interface, 1 RS232	22	22	31	31	67	67	31	31	31	31
Serial interface, 1 RS485/422	22	22	31	31	70	70	31	31	31	31
Encoder, 1 SSI	22	22	31	31	71	71	31	31	31	31

## Economy gateways

Module type	PROFI <sup>®</sup> BUS		CANopen	
	Number of chan.	Number of mod.	Number of chan.	Number of mod.
Digital inputs, 4 DI	136	34	284	71
Digital inputs, 4DI NAMUR	100	25	200	50
Digital inputs, 16 DI	128	8	128	8
Digital inputs, 32 DI	256	8	256	8
Digital outputs, 2 DO-R	56	35	142	71
Digital outputs, 4 DO	132	33	28	71
Digital outputs, 16 DO	128	8	128	8
Digital outputs, 32 DO	256	8	256	8
Analogue inputs, 2 AI-I	56	28	100	50
Analogue inputs, 2 AI-U	56	28	100	50
Analogue inputs, 4 AI-U/I	132	33	108	27
Analogue inputs, 2 AI-PT/NI	44	22	98	49
Analogue inputs, 2 AI-THERMO	44	22	98	49
Analogue outputs, 2 AO-I	50	25	70	35
Analogue outputs, 2 AO-U	46	23	70	35
Counter module, 1 CNT	13	13	27	27
Serial interface, 1 RS232	7	7	27	27
Serial interface, 1 RS485/422	16	16	27	27
Encoder, 1 SSI	20	20	27	27

A BL20 station consists of a gateway and a maximum of 74 modules (approximately 1 m length of rail including end bracket and end plate). With the use of block modules, the maximum number of modules is correspondingly reduced (1 block module corresponds to approximately 8 slice modules).

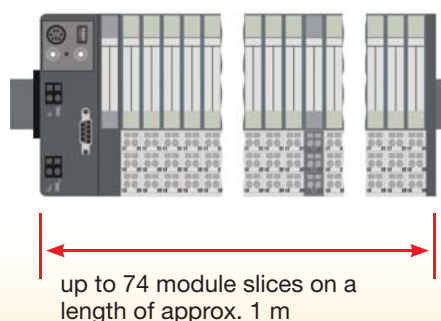

### C-rail (cross connection)

The C-rails run through all I/O base modules. The C-rail of the base modules for power distribution modules is mechanically separated; thus potentially isolating the adjoining supply groups.

### Using the C-rail as a protective earth

The C-rail can be used as required in the application, for example, as a protective earth (PE). In this case, the PE connection of each power distribution module

must be connected to the mounting rail via an additional PE terminal (see accessories), which is available as an accessory.

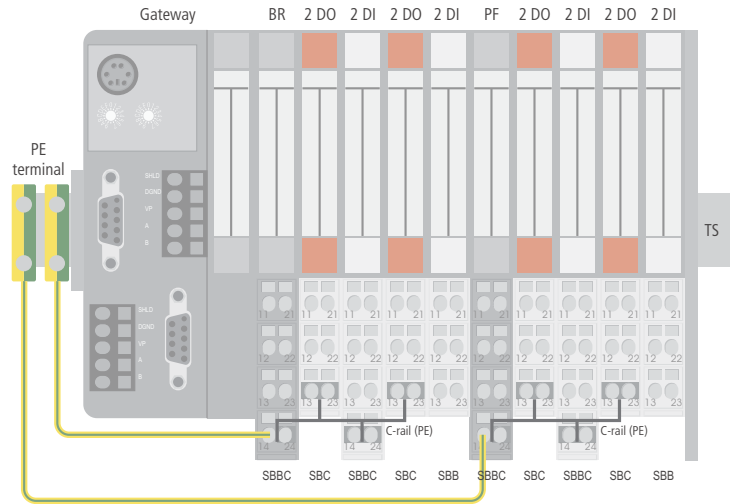

### Access to C-rail

Access to the C-rail is made via base modules with a C in their designation, for example: BL20-S4T-SBCS. The corresponding connection level is indicated by a thick black line on all base modules for BL20 I/O modules.

With base modules for power distribution modules, the black line is above the connection 24 only. This makes clear that the C-rail is separated from the adjoining potential group to its left. A maximum load of 24 VDC to the C-rail is allowed, but never 120/130 VAC.

### Using the C-rail with relay modules

The C-rail can be used to supply a common voltage when relay modules are to be used. To accomplish this, the load voltage (24 VDC) is connected to a power distribution module with the base module BL20-P4x-SBBC using either tension springs or screw connections. All the following relay modules are supplied with 24 VDC via the C-rail (see ①, Fig. below).

The cross-connection of the individual relay modules is achieved using the cross-connector QVR (see ②, Fig. below). If the C-rail is to be used for the joint supply of voltage to relay modules, then there must subsequently be a further power distribution module used for the potential isolation of the following BL20 modules. The C-rail can again be put on other uses (for example, as a PE) once the potential isolation has been made.

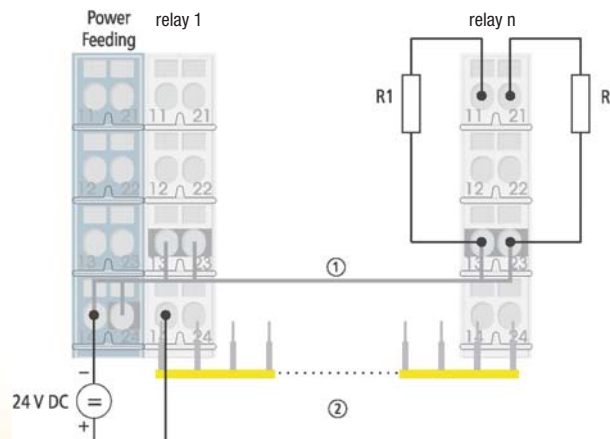

# BL20 – General technical data

## BL20 modules – technical data

### Supply voltage/auxiliary power

Nominal value (provided for other modules)	24 VDC
Residual ripple	according to EN 61131-2
Electrical isolation ( $U_L^2$ to $U_{SYS}^3$ / $U_L$ to fieldbus/ $U_{SYS}$ to fieldbus)	yes, via opto-couplers
Ambient temperature	
Horizontal mounting ambient temperature	0 ... +55 °C
Vertical mounting ambient temperature	0 ... +55 °C
Storage temperature	-25 ... +85 °C
Relative humidity to EN 61131-2/EN 50178	5 ... 95 % (indoor), Level RH-2, no condensation (storage at 45 °C, no functional test)
Corrosive gases	
SO <sub>2</sub>	10 ppm (rel. humidity < 75 %, no condensation)
H <sub>2</sub> S	1.0 ppm (rel. humidity < 75 %, no condensation)
Vibration resistance	
10 to 57 Hz, constant amplitude 0.075 mm, 1 g	yes
57 to 150 Hz, constant amplitude 1 g	yes
Vibration type	Variable frequency runs at a rate of change of 1 octave/min
Vibration duration	20 variable frequency runs per coordinate axis
Shock resistance as per IEC 68-2-27	18 shocks, half-sine 15 g peak value/11 ms, for both ±-directions per spatial coordinate
Repeated shock resistance as per IEC 68-2-29	1000 shocks, half sine 25 g peak value/6 ms, for both ±-directions per spatial coordinate
Drop and topple	
Fall height (weight < 10 kg)	1.0 m
Fall height (weight 10 to 40 kg)	0.5 m
Test runs	7
Electromagnetic compatibility (EMC) as per EN 50082-2 (Industrial)	
Static electricity as per EN 61000-4-2	
Air discharge (direct)	8 kV
Relay discharge (indirect)	4 kV
Electromagnetic HF fields as per EN 61000-4-3 and ENV 50204	
Conducted interference, induced by HF fields as per EN 61000-4-6	10 V
Radiated interference as per EN 50081-2 (industrial)	to EN 55011 class A <sup>1</sup> , group 1

<sup>1</sup> Use in residential areas may lead to functional errors. Additional suppression measures are necessary!

<sup>2</sup>  $U_L$  : Field supply

<sup>3</sup>  $U_{SYS}$  : System supply

## BL20 stations – approvals and tests

Approvals	CE
Tests (EN 61131-2)	
Cold	DIN IEC 68-2-1, temperature -25 °C, duration 96 h; device not operational
Dry heat	DIN IEC 68-2-2, temperature +85 °C, duration 96 h; device not operational
Damp heat, cyclic	DIN IEC 68-2-30, temperature +55 °C, duration 2 cycles of 12 h; device operational
Temperature change	DIN IEC 68-2-14, temperature 0 to +55 °C, duration 2 cycles, temperature change per minute; device operational
Operating life MTBF	120000 h
Extraction/insertion cycles for electronics modules	20
Pollution level as per IEC 664 (EN 61131)	2

## Base modules – technical data

	BL20 Base module	BL20 ECONOMY module
Degree of protection (IEC 60529/EN 60529)	IP20	IP20
Stripped length	8 mm	8 mm
Max. cross-section at terminal	0.5 ... 2.5 mm <sup>2</sup>	0.14 ... 1.5 mm <sup>2</sup>
Conductors to be clamped		
“e” solid H 07V-U	0.5 ... 2.5 mm <sup>2</sup>	0.25 ... 1.5 mm <sup>2</sup>
“f” stranded H 07V-K	0.5 ... 1.5 mm <sup>2</sup>	0.25 ... 1.5 mm <sup>2</sup>
“f” with core-end ferrules to DIN 46228/1 (ferrules are crimped gas-tight)	0.5 ... 1.5 mm <sup>2</sup>	0.25 ... 1.5 mm <sup>2</sup>
on wire end sleeves with plastic collar	0.25 ... 0.75mm <sup>2</sup>	0.25 ... 0.75 mm <sup>2</sup>
Finger test to IEC 947-1/1988	A1	A1
Rating data in accordance with VDE 0611 part 1/8.92/IEC 947-7-1/ 1989		
Rated voltage	250 V	250 V
Rated current	17.5 A	17.5 A
Rated cross-section	1.5 mm <sup>2</sup>	1.5 mm <sup>2</sup>
Rated surge voltage	4 kV	4 kV
Pollution degree	2	2
Connection method in TOP direction	Tension spring connector or screw terminal	Tension spring connector



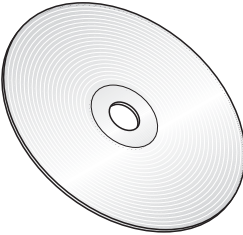
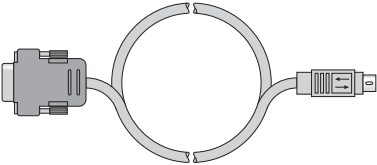

# BL20 – Special accessories

Figure	Description	Type	Ident-No.
	Configuration, commissioning and diagnostic-software for modular fieldbus I/O systems  freeware for download on <a href="http://www.turck.com">http://www.turck.com</a>	<b>I/O-ASSISTANT</b>	–
	RS232 adapter cable for connection to configuration software I/O ASSISTANT, 9-pole SUB-D connector, cable length 2.5 m	<b>I/O-ASSISTANT-Kabel-BL20/BL67</b>	6827133







## User manuals

The user manual for BL20 systems is only available as PDF file and can be downloaded on [www.turck.com](http://www.turck.com)

Designation	Description (per packing unit)	Type	Ident-No.
Labels 	for labelling electronic modules		
	DIN A5 sheets, slice, perforated (laser print) 5 x 57 labels	BL20-LABEL/SCHEIBE	6827070
	DIN A5 sheets, block, perforated (laser print) 5 x 6 labels	BL20-LABEL/BLOCK	6827071
Markers 	for labeling base modules, color identification for clear recognition of potentials in the connection level of the base modules (strip of 10 x 6):		
	blue	BL20-ANBZ-BL	6827072
	red	BL20-ANBZ-RT	6827073
	green	BL20-ANBZ-GN	6827074
	black	BL20-ANBZ-SW	6827075
	brown	BL20-ANBZ-BR	6827076
	red/blue	BL20-ANBZ-RT/BL-BED	6827077
	green/yellow	BL20-ANBZ-GN/GE-BED	6827078
Connector markers 	Dekafix (50 labels per carrier foil/10 foils)		
	labelled 1-50	BL20-FW5/1-50	6827100
	labelled 51-100	BL20-FW5/51-100	6827101
	labelled 101-150	BL20-FW5/101-150	6827102
	labelled 151-200	BL20-FW5/151-200	6827103
Jumpers for relays (QVR) 	for bridging the 4th connection level (14/24) of base modules for relays /10 pcs.		
	1 grid	BL20-QV/1	6827104
	2 grid	BL20-QV/2	6827105
	3 grid	BL20-QV/3	6827106
	4 grid	BL20-QV/4	6827107
	5 grid	BL20-QV/5	6827108
	6 grid	BL20-QV/6	6827109
	7 grid	BL20-QV/7	6827110
	8 grid	BL20-QV/8	6827111
Coding for electronic and base modules 	for coding slots of electronic and base modules (10 coding pieces per packing unit)		
	Electronic module type BL20-...DI-24VDC...	BL20-KO/2	6827112
	Electronic module type BL20-...DO-24VDC...	BL20-KO/6	6827113
	Electronic module type BL20-2DO-R-NO	BL20-KO/8	6827114
	Electronic module type BL20-2DO-R-NC	BL20-KO/9	6827115
	Electronic module type BL20-2DO-R-CO	BL20-KO/10	6827116
	Electronic module type BL20-1AI-I(0/4...20MA)	BL20-KO/11	6827117
	Electronic module type BL20-1AI-U (-10/0...+10V)	BL20-KO/12	6827118
	Electronic module type BL20-1AO-I(0/4...20MA)	BL20-KO/13	6827119
	Electronic module type BL20-2AO-U (-10/0...+10V)	BL20-KO/14	6827120
	Electronic module type power distribution module 24 VDC	BL20-KO/16	6827121
	Electronic module type BL20-PF-120/230VAC-D	BL20-KO/17	6827122

# BL20 – Special accessories

Designation	Description (per packing unit)	Type	Ident-No.
End plate 	mechanical termination of the BL20 station on the right-hand side, included with gateways	BL20-ABPL	6827123
End bracket, black 	mechanical fixing of the BL20 station, 2 pcs., included with gateways	BL20-WEW-35/2-SW	6827124
Shield connection 	shield connection for direct wiring of BL20 gateway	BL20-SCH-1	6827125
	shield connection for analogue signals, 10 pcs.		
	tension spring screw	BL20-KLBU/T BL20-KLBU/S	6827126 6827127
Ferrite ring	for damping high-frequency interference signals to data and supply lines (2 ferrite rings per packing unit)	BL20-ZBX-405	6827128
<b>Tools</b> tension spring operating tool 	tension spring operating tool	ZBW5	6827129



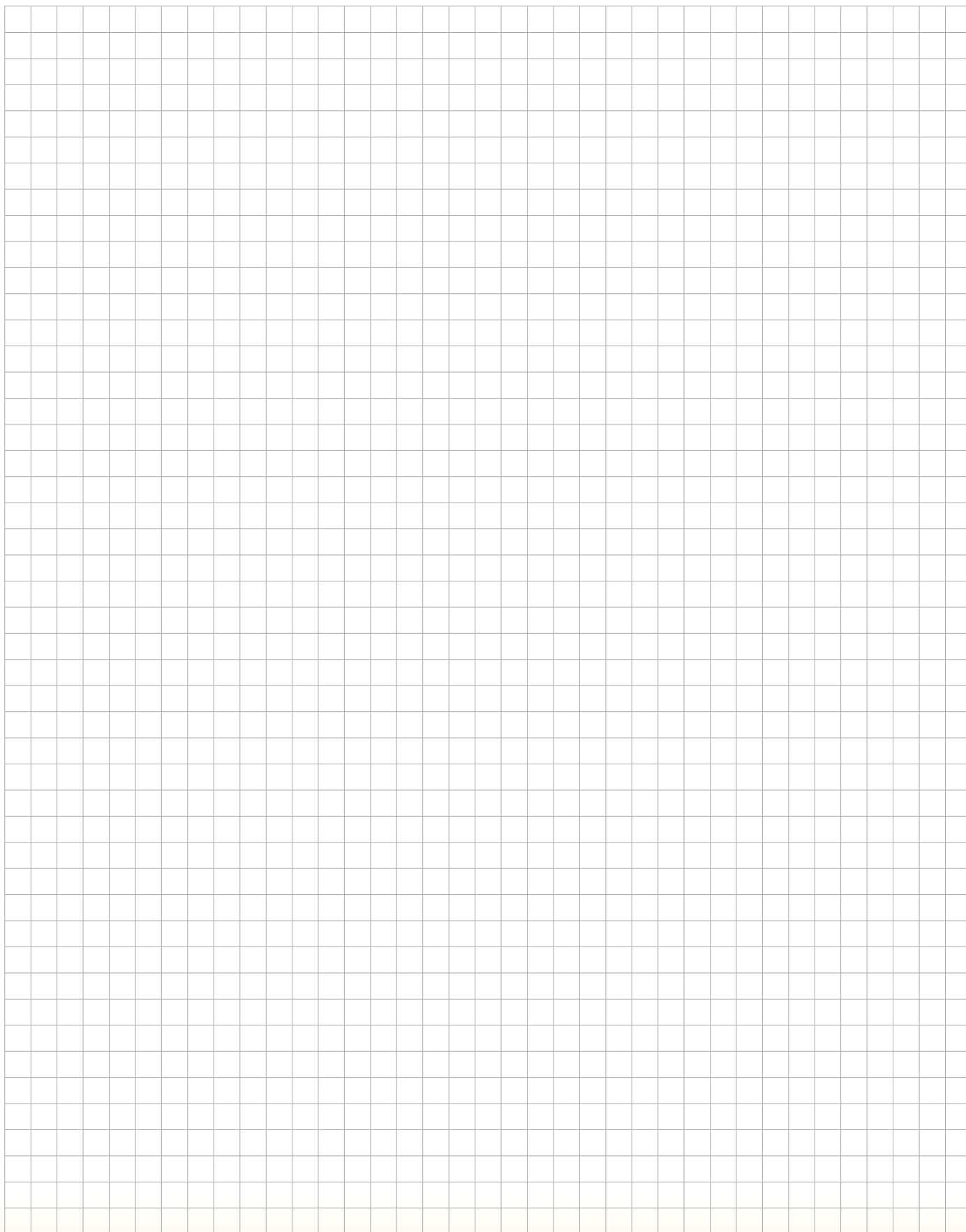

**Gateway for BL20 I/O system  
Interface for PROFIBUS-DP incl. supply  
BL20-GW-DPV1**

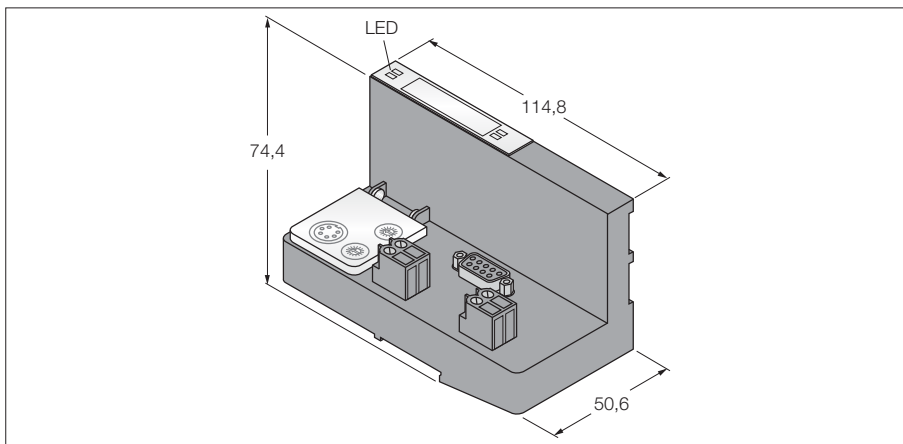

- Rotary coding switch for adjustment of the node address
- Degree of protection IP20
- 2 x end brackets BL20-WEW35/2-SW
- 1 x end plate BL20-ABPL
- With integrated supply
- LEDs for display of supply voltage, common alarm and bus errors
- Interface between the BL20 system and PROFIBUS-DPV0/DPV1
- 12 Mbps
- 9-pole sub-D female connector

<b>Type</b>	BL20-GW-DPV1
Ident-No.	6827234
<b>System power supply</b>	24 VDC / 5 VDC
Field supply	24 VDC
Admissible range	18...30 VDC
Rated current from module bus	≤ 430 mA
Max. field supply current	10 A
Max. system supply current	1.5 A
Voltage supply connection	screw connection
<b>Fieldbus transmission rate</b>	9.6 kbps up to 12 Mbps
Fieldbus addressing range	1...99
Fieldbus addressing	2 rotary switches
Service interface	PS/2 socket for I/O-ASSISTANT
Fieldbus connection technology	1 x female sub-D connector
Voltage supply connection	screw connection
Fieldbus connection	external
<b>Number of diagnostic bytes</b>	3
Number of parameter bytes	5
<b>Operating temperature</b>	0 to +55 °C

**Field supply/system supply**

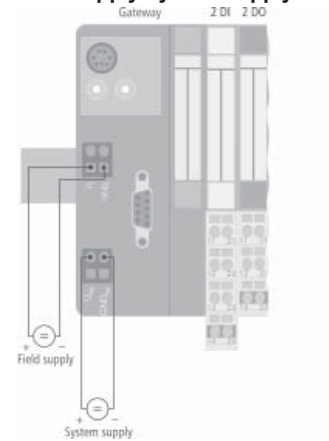

**Gateway for BL20 I/O system  
Interface for PROFIBUS-DP  
BL20-E-GW-DP**

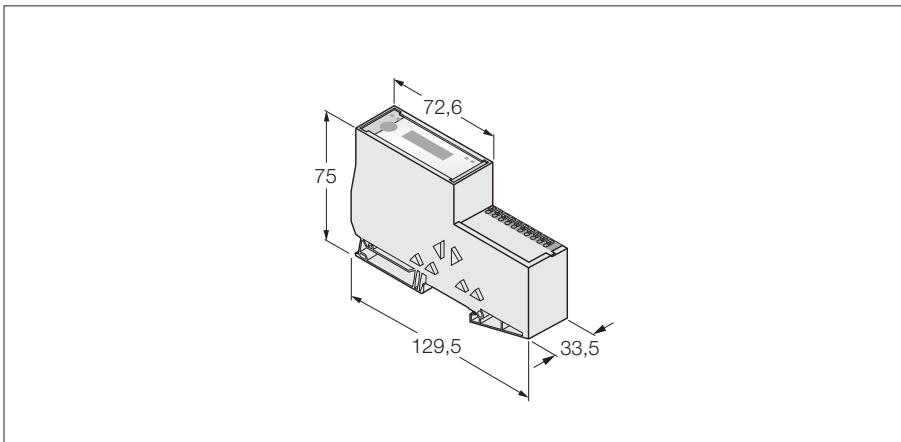

- DIP switch rotary for adjustment of the node address
- Degree of protection IP20
- 2 x end brackets BL20-WEW35/2-SW
- 1 x end plate BL20-ABPL
- With integrated supply
- LEDs for display of supply voltage, common alarm and bus errors
- Interface between the BL20 system and PROFIBUS-DPV0/DPV1
- 12 Mbit/s
- Push-in clamps

<b>Type</b>	BL20-E-GW-DP
Ident-No.	6827250
<b>System power supply</b>	24 VDC / 5 VDC
Field supply	24 VDC
Admissible range	18...30 VDC
Rated current from module bus	≤ 430 mA
Max. field supply current	10 A
Max. system supply current	1 A
Voltage supply connection	Push-in clamps
<b>Fieldbus transmission rate</b>	9.6 kbps up to 12 Mbps
Fieldbus addressing range	1...126
Fieldbus addressing	per DIP switch
Service interface	PS/2 socket for I/O-ASSISTANT
Fieldbus connection technology	push-in clamps
Voltage supply connection	push-in clamps
Fieldbus connection	per DIP switch
<b>Number of diagnostic bytes</b>	3
Number of parameter bytes	5
<b>Operating temperature</b>	0 to +55 °C

**Field supply/system supply**

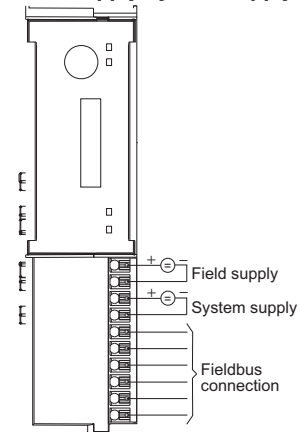

# Gateway for BL20 I/O system Interface for DeviceNet incl. supply BL20-GWBR-DNET

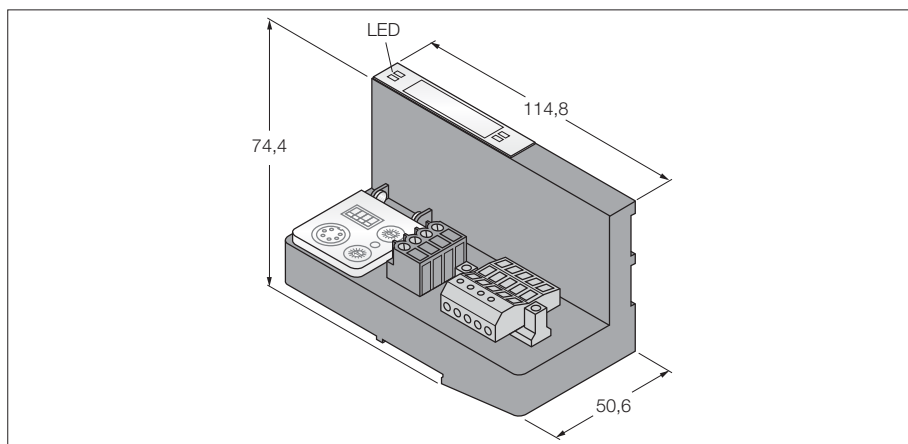

- Rotary coding switch for adjustment of the node address
- Degree of protection IP20
- 2 x end brackets BL20-WEW35/2-SW
- 1 x end plate BL20-ABPL
- With integrated supply
- LEDs for display of supply voltage, common alarm and bus errors
- Interface between the BL20 system and DeviceNet
- 125 / 250 / 500 kbps
- The connection to DeviceNet is established via an Open-Style-Connector

<b>Type</b>	BL20-GWBR-DNET
Ident-No.	6827168
<b>System power supply</b>	24 VDC / 5 VDC
Field supply	24 VDC
Admissible range	18...30 VDC
Rated current from module bus	≤ 250 mA
Max. field supply current	10 A
Max. system supply current	1.5 A
Voltage supply connection	screw connection
<b>Fieldbus transmission rate</b>	125/250/500 kbps, DIP switch
Fieldbus addressing range	0...63
Fieldbus addressing	2 rotary switches
Service interface	PS/2 socket for I/O-ASSISTANT
Fieldbus connection technology	open connector
Voltage supply connection	screw connection
Fieldbus connection	external
<b>Operating temperature</b>	0 to +55 °C

## Field supply/system supply

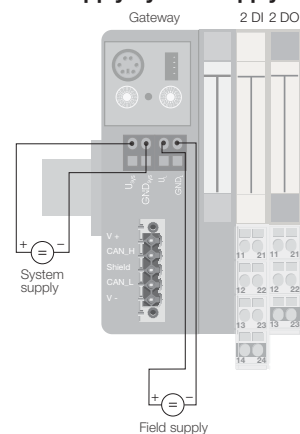

**Gateway for BL20 I/O system  
Interface for CANopen incl. supply  
BL20-GWBR-CANOPEN**

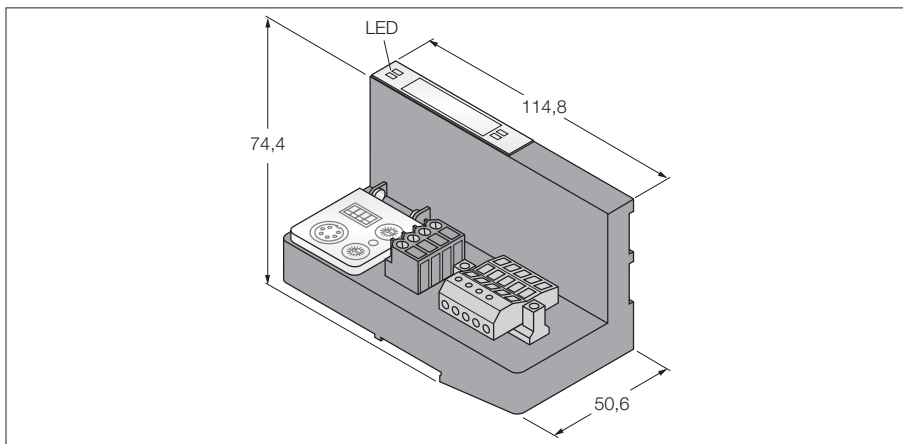

- Rotary coding switch for adjustment of the node address
- Degree of protection IP20
- 2 x end brackets BL20-WEW35/2-SW
- 1 x end plate BL20-ABPL
- With integrated supply
- LEDs for display of supply voltage, common alarm and bus errors
- Interface between BL20 system and CAN bus
- 20 kbps up to 1000 kbps
- The connection to CANopen is established via an open-style connector

<b>Type</b>	BL20-GWBR-CANOPEN
Ident-No.	6827167
<b>System power supply</b>	24 VDC / 5 VDC
Field supply	24 VDC
Admissible range	18...30 VDC
Rated current from module bus	≤ 350 mA
Max. field supply current	10 A
Max. system supply current	1.5 A
Voltage supply connection	screw connection
<b>Fieldbus transmission rate</b>	20 to 1000 kbps, DIP switch
Fieldbus addressing range	1...99
Fieldbus addressing	2 rotary switches
Service interface	PS/2 socket for I/O-ASSISTANT
Fieldbus connection technology	open connector
Voltage supply connection	screw connection
Fieldbus connection	external
<b>Operating temperature</b>	0 to +55 °C

**Field supply/system supply**

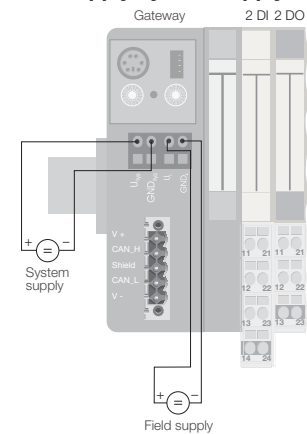

**Gateway for BL20 I/O system  
Interface for CANopen  
BL20-E-GW-CO**

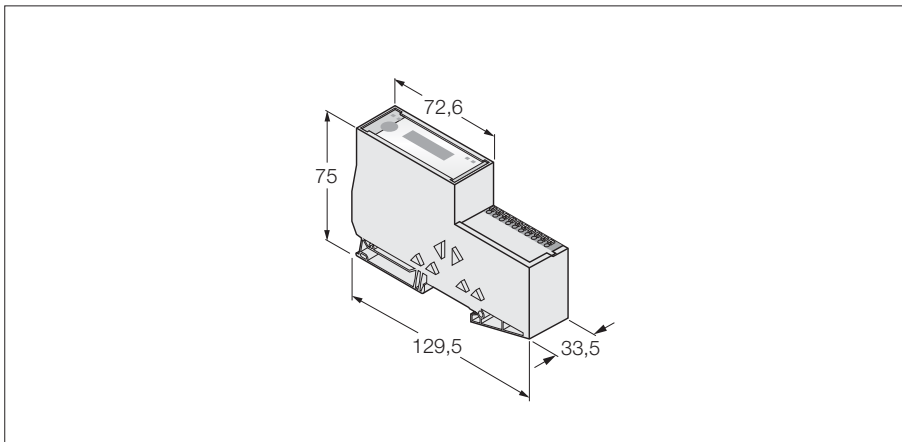

- DIP switch rotary for adjustment of the node address
- Degree of protection IP20
- 2 x end brackets BL20-WEW35/2-SW
- 1 x end plate BL20-ABPL
- With integrated supply
- LEDs for display of supply voltage, common alarm and bus errors
- Interface between the BL20 system and CANopen
- 1 Mbps
- Push-in clamps

<b>Type</b>	BL20-E-GW-CO
Ident-No.	6827252
<b>System power supply</b>	24 VDC / 5 VDC
Field supply	24 VDC
Admissible range	18...30 VDC
Rated current from module bus	≤ 430 mA
Max. field supply current	10 A
Max. system supply current	1.5 A
Voltage supply connection	push-in clamps
<b>Fieldbus transmission rate</b>	125 kbps to 500 kbps
Fieldbus addressing range	1...63
Fieldbus addressing	per DIP switch
Service interface	PS/2 socket for I/O-ASSISTANT
Fieldbus connection technology	push-in clamps
Voltage supply connection	push-in clamps
Fieldbus connection	per DIP switch
<b>Number of diagnostic bytes</b>	3
Number of parameter bytes	5
<b>Operating temperature</b>	0 to +55 °C

**Field supply/system supply**

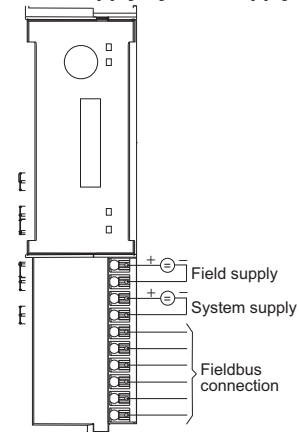

**Gateway for BL20 I/O system  
Interface for MODBUS TCP incl. supply  
BL20-GW-EN**

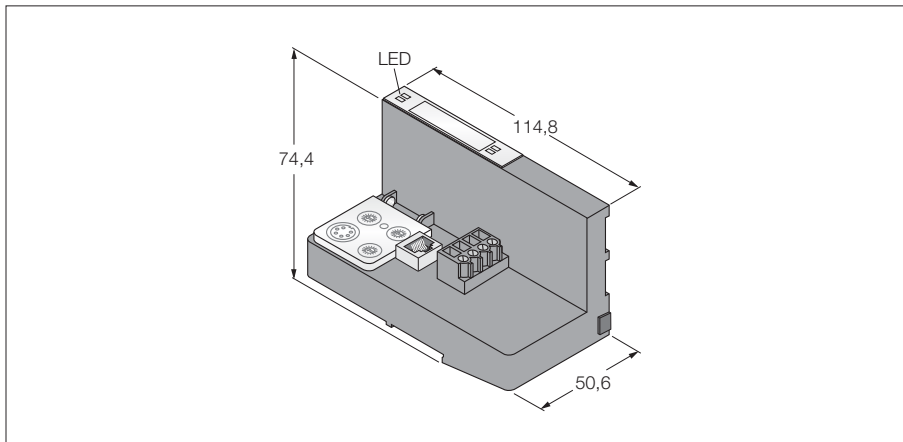

- Rotary coding switch for adjustment of the node address
- Degree of protection IP20
- 2 x end brackets BL20-WEW35/2-SW
- 1 x end plate BL20-ABPL
- With integrated supply
- LEDs for display of supply voltage, common alarm and bus errors
- Interface between the BL20 system and MODBUS TCP
- 10/100 Mbps
- RJ45 socket

<b>Type</b>	BL20-GW-EN
Ident-No.	6827237
<b>System power supply</b>	24 VDC / 5 VDC
Field supply	24 VDC
Admissible range	18...30 VDC
Rated current from module bus	≤ 500 mA
Max. field supply current	10 A
Max. system supply current	1.5 A
Voltage supply connection	screw connection
<b>Fieldbus transmission rate</b>	10/100 Mbps
Fieldbus addressing	rotary switch, BOOTP, DHCP, IO-ASSISTANT
Service interface	PS/2 socket for I/O-ASSISTANT
Fieldbus connection technology	RJ45 socket
Voltage supply connection	screw connection
<b>Operating temperature</b>	0 to +55 °C

**Field supply/system supply**

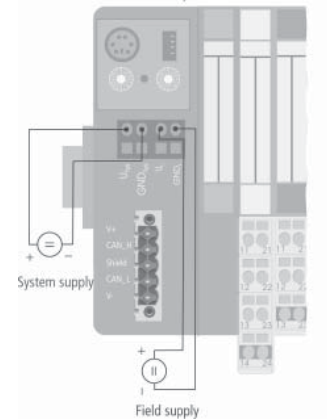

# Gateway for BL20 I/O system Interface for EtherNet/IP supply inclusive BL20-GW-EN-IP

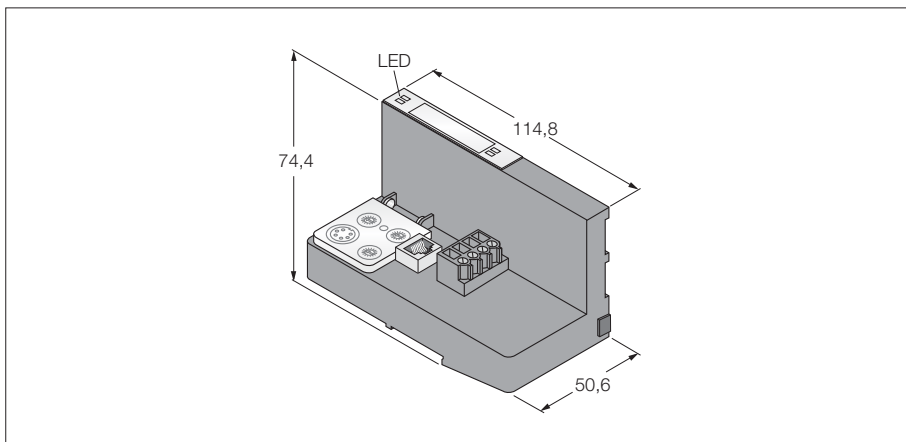

- Rotary coding switch for adjustment of the node address
- Degree of protection IP20
- 2 x end brackets BL20-WEW35/2-SW
- 1 x end plate BL20-ABPL
- With integrated supply
- LEDs for display of supply voltage, common alarm and bus errors
- Interface between the BL20 system and EtherNet/IP
- 10/100 Mbps
- RJ45 socket

<b>Type</b>	BL20-GW-EN-IP
Ident-No.	6827247
<b>System power supply</b>	24 VDC / 5 VDC
Field supply	24 VDC
Admissible range	18...30 VDC
Rated current from module bus	≤ 500 mA
Max. field supply current	10 A
Max. system supply current	1.5 A
Voltage supply connection	screw connection
<b>Fieldbus transmission rate</b>	10/100 Mbps
Fieldbus addressing	rotary switch, BOOTP, DHCP, IO-ASSISTANT
Service interface	PS/2 socket for I/O-ASSISTANT
Fieldbus connection technology	RJ45 socket
Voltage supply connection	screw connection
<b>Operating temperature</b>	0 to +55 °C

## Field supply/system supply

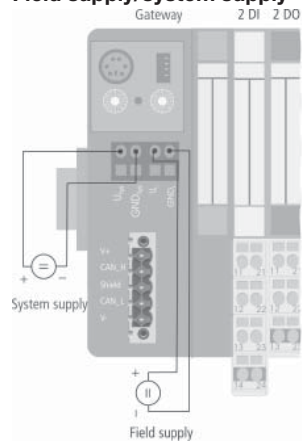



**Programmable gateway for the BL20 I/O system  
Interface for MODBUS TCP incl. supply  
BL20-PG-EN**

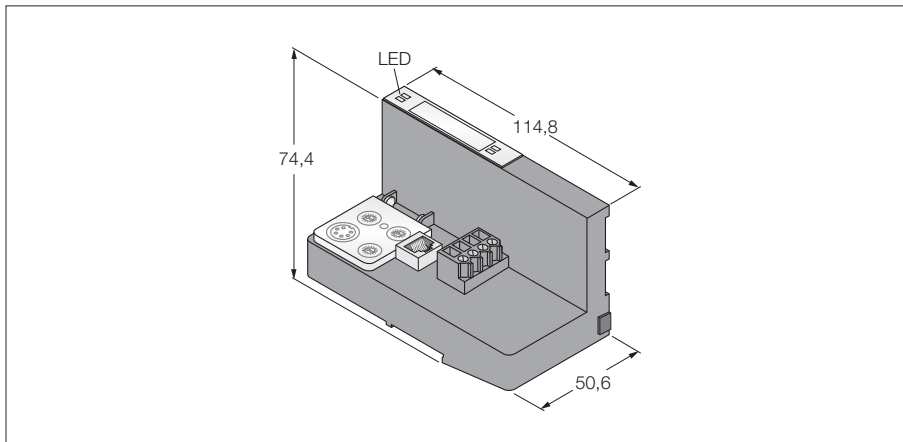

- Programmable acc.to IEC 61131-3 with CoDeSys
- Ethernet and RS232 programmable interface
- 512 kByte program memory
- 32 Bit RISC processor
- < 1 ms for 1000 instructions
- 3 decimally coded rotary switches
- Degree of protection IP20
- With integrated supply
- LEDs for display of supply voltage, common alarm and bus errors
- Interface for MODBUS TCP
- 10/100 Mbps

<b>Type</b>	BL20-PG-EN
Ident-No.	6827249
<b>System power supply</b>	24 VDC
Admissible range	18...30 VDC
Rated current from module bus	≤ 500 mA
Max. field supply current	10 A
Max. system supply current	1.5 A
Voltage supply connection	screw connection
<b>Fieldbus transmission rate</b>	10/100 Mbps
Fieldbus addressing	rotary switch, BOOTP, DHCP, IO-ASSISTANT
Service interface	PS/2 socket for I/O-ASSISTANT
Fieldbus connection technology	RJ45 socket
Voltage supply connection	screw connection
<b>PLC data</b>	
Programming	CoDeSys V2.3
Released for CoDeSys version	V 2.3.6.4
Programming languages	IEC 61131-3 (IL, LD, FBD, SFC, ST)
Application tasks	1
Number of POUs	1024
Programming interface	RS232 interface, Ethernet
	RISC
	32 bit
Cycle time	< 1 ms for 1000 IL commands (without I/O cycle)
Program memory	512 kByte
Data memory	512 kByte
Input data	4 kByte
Output data	4 kByte
Non-volatile memory	16 kByte
<b>Operating temperature</b>	0 to +55 °C

**Field supply/system supply**

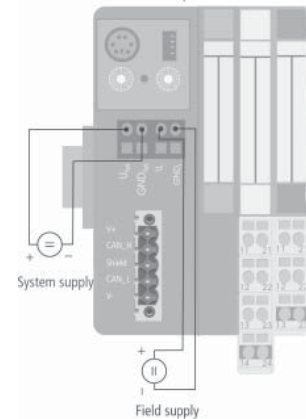

# Programmable gateway for the BL20 I/O system Interface for EtherNet/IP supply inclusive BL20-PG-EN-IP

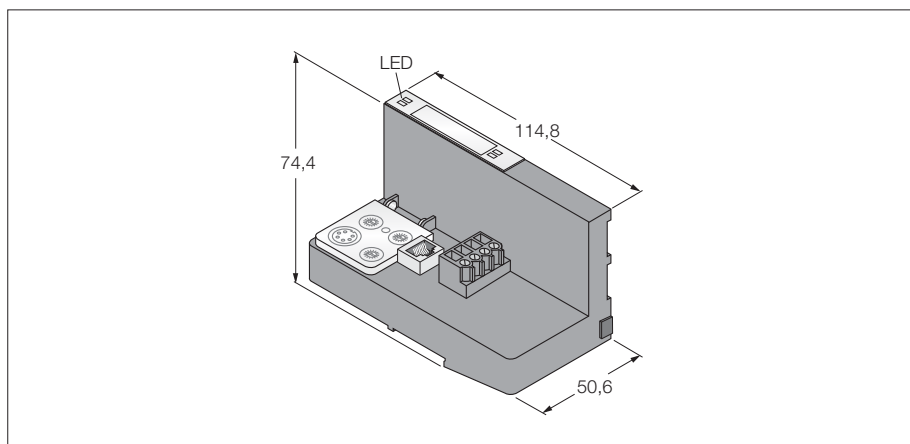

- Programmable acc.to IEC 61131-3 with CoDeSys
- Ethernet and RS232 programmable interface
- 512 kByte program memory
- 32 Bit RISC processor
- < 1 ms for 1000 instructions
- 3 decimally coded rotary switches
- Degree of protection IP20
- With integrated supply
- LEDs for display of supply voltage, common alarm and bus errors
- Interface for EtherNet/IP
- 10/100 Mbps

<b>Type</b>	BL20-PG-EN-IP
Ident-No.	6827248
<b>System power supply</b>	24 VDC
Admissible range	18...30 VDC
Rated current from module bus	≤ 500 mA
Max. field supply current	10 A
Max. system supply current	1.5 A
Voltage supply connection	screw connection
<b>Fieldbus transmission rate</b>	10/100 Mbps
Fieldbus addressing	rotary switch, BOOTP, DHCP, IO-ASSISTANT
Service interface	PS/2 socket for I/O-ASSISTANT
Fieldbus connection technology	RJ45 socket
Voltage supply connection	screw connection
<b>PLC data</b>	
Programming	CoDeSys V2.3
Released for CoDeSys version	V 2.3.6.4
Programming languages	IEC 61131-3 (IL, LD, FBD, SFC, ST)
Application tasks	1
Number of POU's	1024
Programming interface	RS232 interface, Ethernet
	RISC
	32 bit
Cycle time	< 1 ms for 1000 IL commands (without I/O cycle)
Program memory	512 kByte
Data memory	512 kByte
Input data	4 kByte
Output data	4 kByte
Non-volatile memory	16 kByte
<b>Operating temperature</b>	0 to +55 °C

## Field supply/system supply

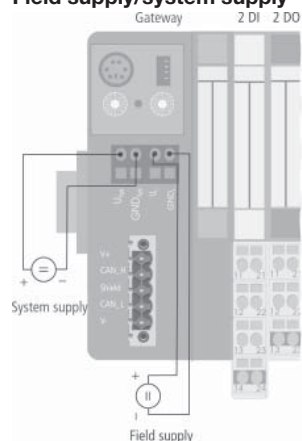

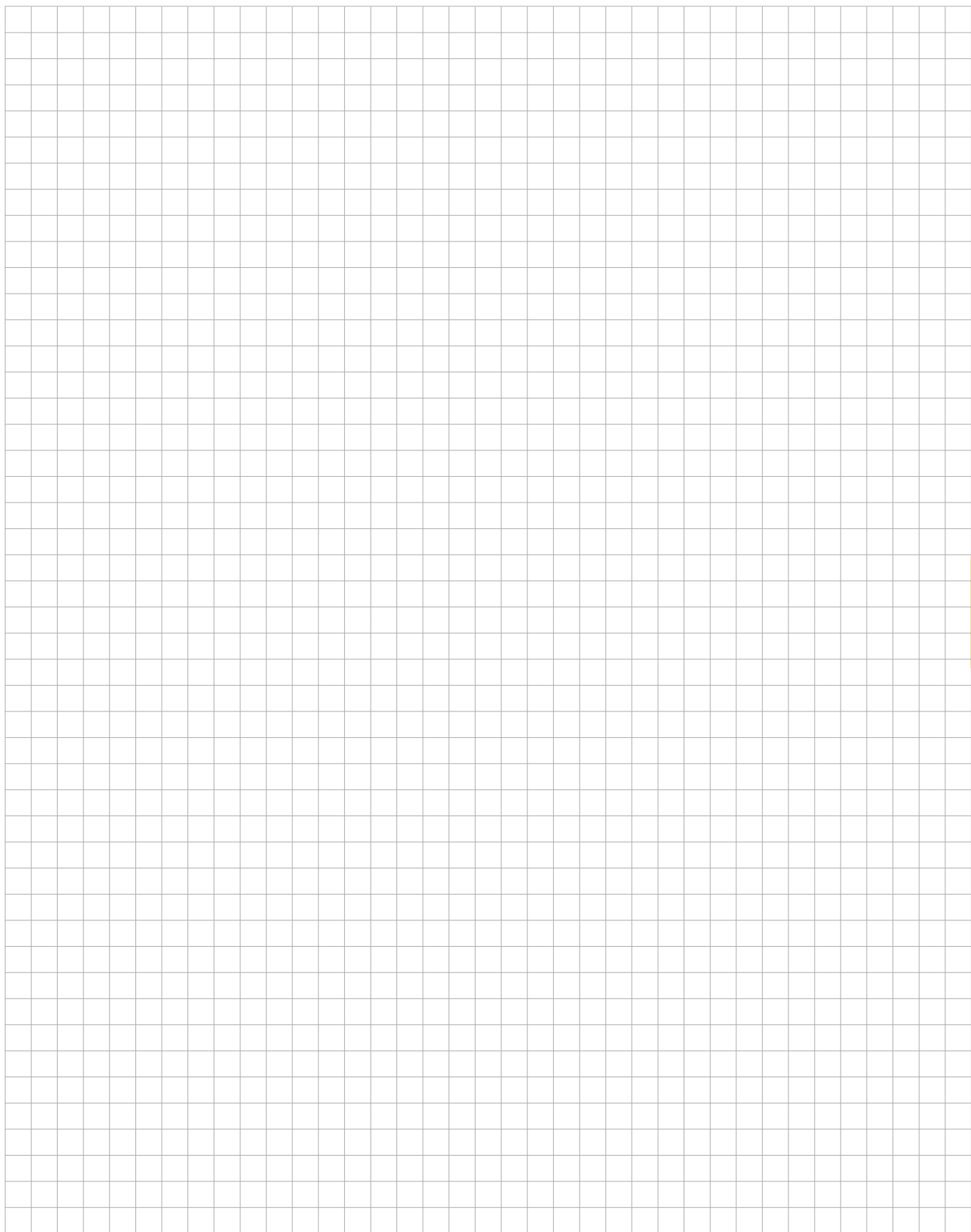

**BL20 electronic module**  
**Bus refreshing module with diagnostics**  
**BL20-BR-24VDC-D**

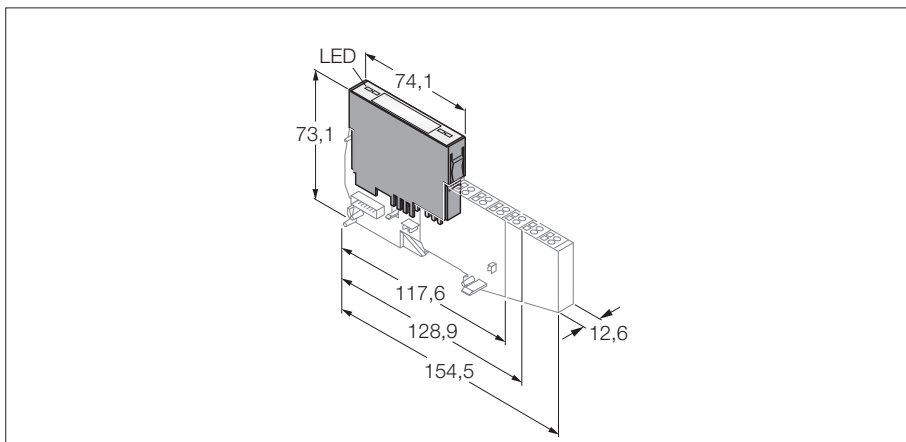

- Independent of the type of field-bus and connection technology used
- Degree of protection IP20
- LEDs for display of system status, field supply and diagnostic information
- Can be used to form potential groups
- Power supply of the BL20 I/O module and the gateway with a nominal system voltage of 5 VDC via the internal module bus
- Field supply featuring a rated voltage of 24 VDC

<b>Type</b>	BL20-BR-24VDC-D
Ident-No.	6827006
<b>System power supply</b>	24 VDC / 5 VDC
Field supply	24 VDC
Admissible range	18...30 VDC
Max. field supply current	10 A
Max. system supply current	1.5 A
<b>Number of diagnostic bits</b>	4
<b>Operating temperature</b>	0 to +55 °C

**BL20 electronic module  
Bus refreshing module with diagnostics  
BL20-BR-24VDC-D**

**Compatible base modules**

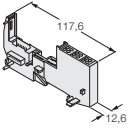
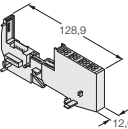
Dimensions	Type	Connection
	<b>6827036 BL20-P3T-SBB</b> Tension spring connection, with gateway supply	F186
	<b>6827037 BL20-P3S-SBB</b> <b>Screw connection, with gateway supply</b>  Is placed on the right side of the gateway (for gateways without integrated power supply).	
	<b>6827040 BL20-P3T-SBB-B</b> Tension spring connection, without gateway supply	
	<b>6827041 BL20-P3S-SBB-B</b> Screw connection, without gateway supply  Is applied to bigger BL20 systems in order to supply the module bus if required.	
Dimensions	Type	Connection
	<b>6827038 BL20-P4T-SBBC</b> Tension spring connection, C rail, with gateway supply	F187
	<b>6827039 BL20-P4S-SBBC</b> Screw connection, C rail, with gateway supply  Is placed on the right side of the gateway (for gateways without integrated power supply).	
	<b>6827042 BL20-P4T-SBBC-B</b> Tension spring connection, C rail, without gateway supply	
	<b>6827043 BL20-P4S-SBBC-B</b> Screw connection, C rail, without gateway supply  Is applied to bigger BL20 systems in order to supply the module bus if required.	

**Connection**

F186 - Wiring diagram

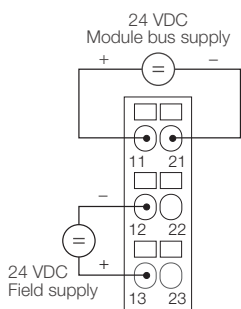

F187 - Wiring diagram

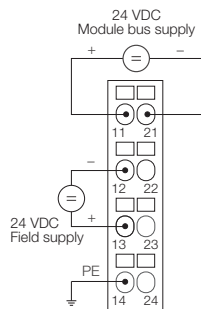

**BL20 electronic module**  
**Power feeding module with diagnostics**  
**BL20-PF-24VDC-D**

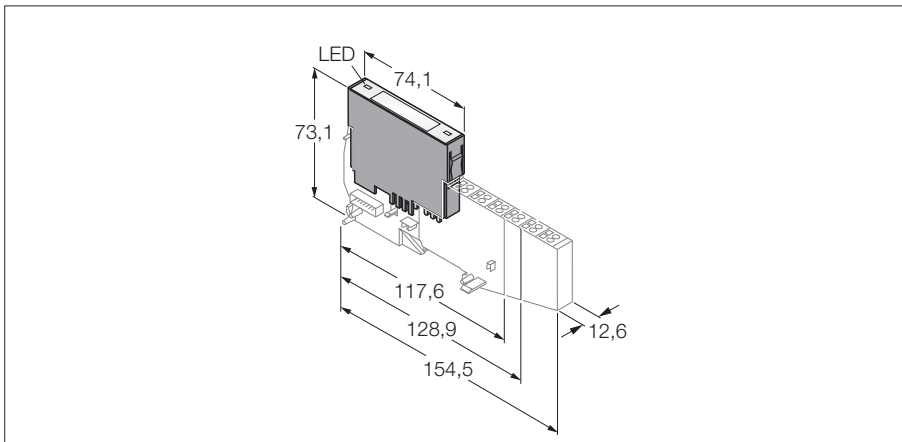

- Independent of the type of field-bus and connection technology used
- Degree of protection IP20
- LEDs for display of system status, field supply and diagnostic information
- Can be used to form potential groups
- Field supply featuring a rated voltage of 24 VDC

<b>Type</b>	BL20-PF-24VDC-D
Ident-No.	6827007
<b>Field supply</b>	24 VDC
Admissible range	18...30 VDC
Rated current from module bus	≤ 28 mA
Max. field supply current	10 A
<b>Number of diagnostic bits</b>	4
<b>Operating temperature</b>	0 to +55 °C

**BL20 electronic module**  
**Power feeding module with diagnostics**  
**BL20-PF-24VDC-D**

**Compatible base modules**

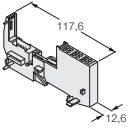
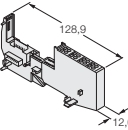
Dimensions	Type	Connection
	<b>6827036 BL20-P3T-SBB</b> Tension spring connection	F188
	<b>6827037 BL20-P3S-SBB</b> Screw connection	
Dimensions	Type	Connection
	<b>6827038 BL20-P4T-SBBC</b> Tension spring connection, access to C rail	F189
	<b>6827039 BL20-P4S-SBBC</b> Screw connection, access to C rail	

**Connection**

F188 - Wiring diagram

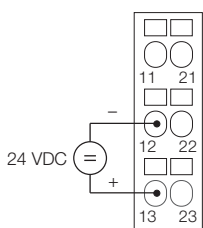

F189 - Wiring diagram

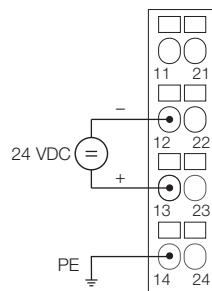

**BL20 electronic module**  
**Power feeding module with diagnostics**  
**BL20-PF-120/230VAC-D**

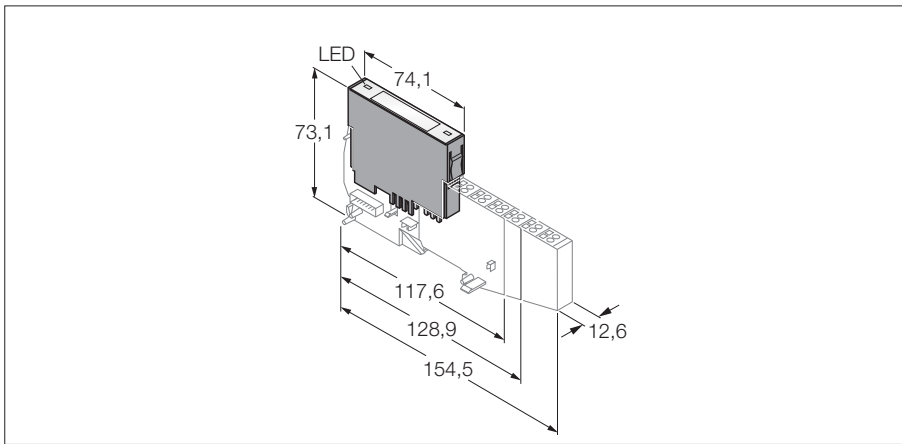

- Independent of the type of field-bus and connection technology used
- Degree of protection IP20
- LEDs for display of system status, field supply and diagnostic information
- Can be used to form potential groups
- Field supply featuring a rated voltage of 120/230 VAC

<b>Type</b>	BL20-PF-120/230VAC-D
Ident-No.	6827008
<b>Field supply</b>	120 / 230 VAC
Admissible range	acc. to EN 61131-2
Rated current from module bus	≤ 25 mA
Max. field supply current	10 A
<b>Number of diagnostic bits</b>	4
<b>Operating temperature</b>	0 to +55 °C



**BL20 electronic module**  
**Power feeding module with diagnostics**  
**BL20-PF-120/230VAC-D**

**Compatible base modules**

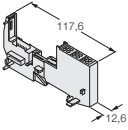
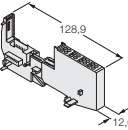
Dimensions	Type	Connection
	<b>6827036 BL20-P3T-SBB</b> Tension spring connection	F190
	<b>6827037 BL20-P3S-SBB</b> Screw connection	
Dimensions	Type	Connection
	<b>6827038 BL20-P4T-SBBC</b> Tension spring connection, access to C rail	F191
	<b>6827039 BL20-P4S-SBBC</b> Screw connection, access to C rail	

**Connection**

F190 - Wiring diagram

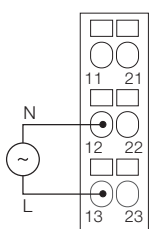

F191 - Wiring diagram

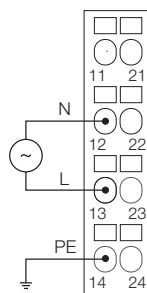

**BL20 electronic module**  
**2 digital inputs**  
**BL20-2DI-24VDC-P**

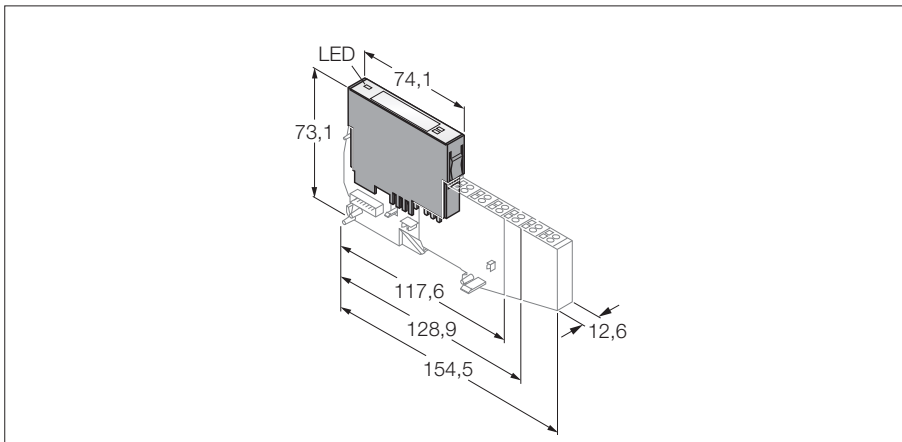

- Independent of the type of field-bus and connection technology used
- Degree of protection IP20
- LEDs for display of status and diagnostics
- Electronics galvanically isolated from the field level via opto-couplers
- 2 digital inputs, 24 VDC
- pnp

<b>Type</b>	BL20-2DI-24VDC-P
Ident-No.	6827009
<b>Number of channels</b>	2
Rated voltage from the supply terminal	24 VDC
Rated current from field supply	≤ 20 mA
Rated current from module bus	≤ 28 mA
Power loss, typical	≤ 0.7 W
<b>Inputs</b>	
Input type	pnp
Low level signal voltage	-30 V ... +5 V
High level signal voltage	15 V ... 30 V
Low level signal current	0 mA ... 1.5 mA
High level signal current	2 mA ... 10 mA
Input delay	< 0.2 ms
Electrical isolation	electronics for the field level
<b>Operating temperature</b>	0 to +55 °C

**BL20 electronic module**  
**2 digital inputs**  
**BL20-2DI-24VDC-P**

**Compatible base modules**

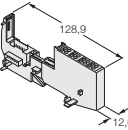
Dimensions	Type	Connection
	<b>6827044 BL20-S3T-SBB</b> Tension spring connection	F192
	<b>6827045 BL20-S3S-SBB</b> Screw connection	
Dimensions	Type	Connection
	<b>6827050 BL20-S4T-SBBC</b> Tension spring connection, access to C rail	F193
	<b>6827051 BL20-S4S-SBBC</b> Screw connection, access to C rail	

**Connection**

F192 - Wiring diagram

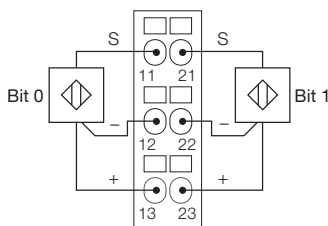

F193 - Wiring diagram

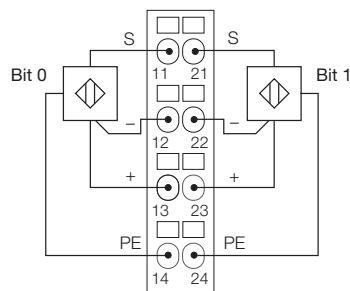

**BL20 electronic module**  
**2 digital inputs**  
**BL20-2DI-24VDC-N**

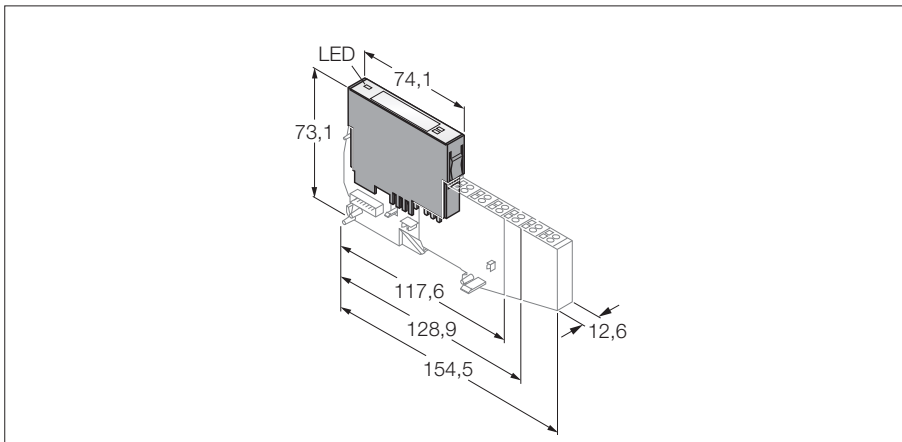

- Independent of the type of field-bus and connection technology used
- Degree of protection IP20
- LEDs for display of status and diagnostics
- Electronics galvanically isolated from the field level via opto-couplers
- 2 digital inputs, 24 VDC
- npn

<b>Type</b>	BL20-2DI-24VDC-N
Ident-No.	6827010
<b>Number of channels</b>	2
Rated voltage from the supply terminal	24 VDC
Rated current from field supply	≤ 20 mA
Rated current from module bus	≤ 28 mA
Power loss, typical	≤ 0.7 W
<b>Inputs</b>	
Input type	npn
Low level signal voltage	> 13 V
High level signal voltage	0 V ... +5 V
Low level signal current	0...1.2 mA
High level signal current	1.3...6 mA
Input delay	< 0.2 ms
Electrical isolation	electronics for the field level
<b>Operating temperature</b>	0 to +55 °C

**BL20 electronic module**  
**2 digital inputs**  
**BL20-2DI-24VDC-N**

**Compatible base modules**

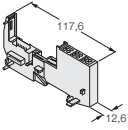
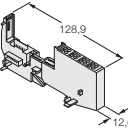
Dimensions	Type	Connection
	<b>6827044 BL20-S3T-SBB</b> Tension spring connection	F194
	<b>6827045 BL20-S3S-SBB</b> Screw connection	
Dimensions	Type	Connection
	<b>6827050 BL20-S4T-SBBC</b> Tension spring connection, access to C rail	F195
	<b>6827051 BL20-S4S-SBBC</b> Screw connection, access to C rail	

**Connection**

F194 - Wiring diagram

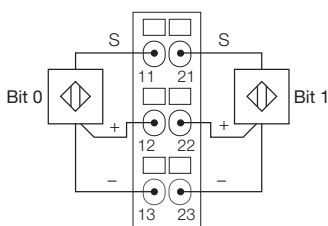

F195 - Wiring diagram

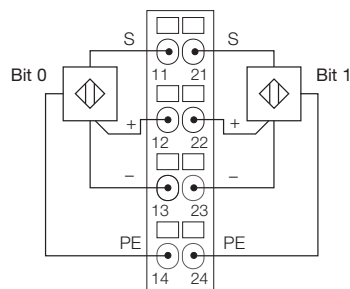

**BL20 electronic module**  
**2 digital inputs**  
**BL20-2DI-120/230VAC-P**

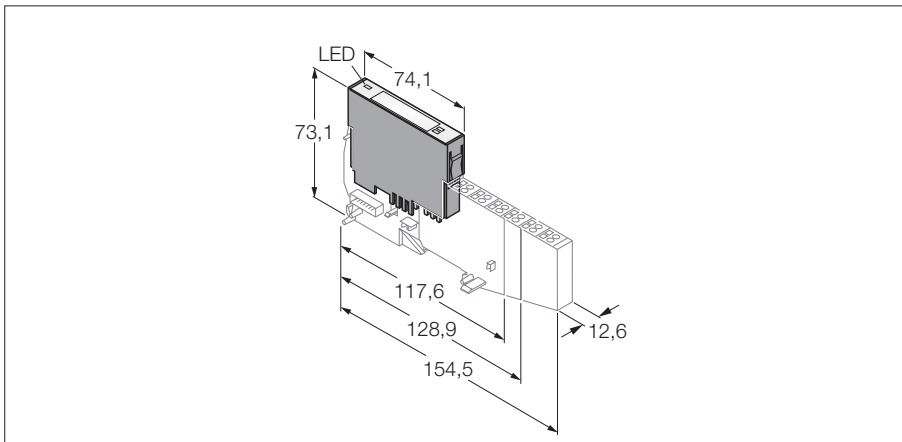

- Independent of the type of field-bus and connection technology used
- Degree of protection IP20
- LEDs for display of status and diagnostics
- Electronics galvanically isolated from the field level via opto-couplers
- 2 digital inputs, 120/230 VAC

<b>Type</b>	BL20-2DI-120/230VAC-P
Ident-No.	6827011
<b>Number of channels</b>	2
Rated voltage from the supply terminal	120 / 230 VAC
Rated current from field supply	≤ 20 mA
Rated current from module bus	≤ 28 mA
Power loss, typical	≤ 1 W
<b>Inputs</b>	
Low level signal voltage	0 V ... 20 VAC
High level signal voltage	79 VAC ... 265 VAC
Frequency range	47.5 Hz to 63 Hz
Low level signal current	0 mA ... 1 mA
High level signal current	3 mA ... 10 mA
Input delay	< 20 ms
Electrical isolation	electronics for the field level
<b>Operating temperature</b>	0 to +55 °C

**BL20 electronic module  
2 digital inputs  
BL20-2DI-120/230VAC-P**

**Compatible base modules**

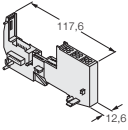
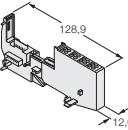
Dimensions	Type	Connection
	<b>6827044 BL20-S3T-SBB</b> Tension spring connection	F196
	<b>6827045 BL20-S3S-SBB</b> Screw connection	
Dimensions	Type	Connection
	<b>6827050 BL20-S4T-SBBC</b> Tension spring connection, access to C rail	F197
	<b>6827051 BL20-S4S-SBBC</b> Screw connection, access to C rail	

**Connection**

F196 - Wiring diagram

F197 - Wiring diagram

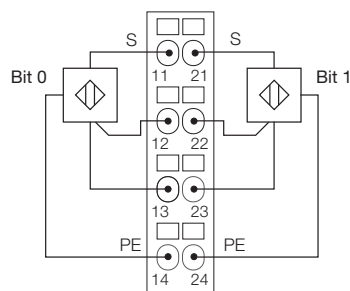
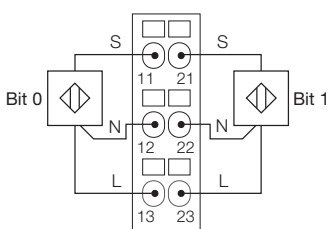

**BL20 electronic module**  
**4 digital inputs**  
**BL20-4DI-24VDC-P**

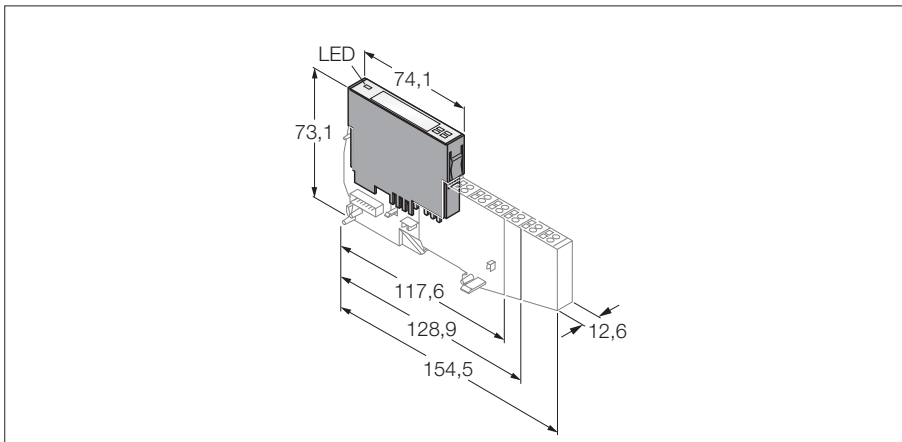

- Independent of the type of field-bus and connection technology used
- Degree of protection IP20
- LEDs for display of status and diagnostics
- Electronics galvanically isolated from the field level via opto-couplers
- 4 digital inputs, 24 VDC
- pnp

<b>Type</b>	BL20-4DI-24VDC-P
Ident-No.	6827012
<b>Number of channels</b>	4
Rated voltage from the supply terminal	24 VDC
Rated current from field supply	≤ 40 mA
Rated current from module bus	≤ 28 mA
Power loss, typical	≤ 1 W
<b>Inputs</b>	
Input type	pnp
Low level signal voltage	-30 V ... +5 V
High level signal voltage	15 V ... 30 V
Low level signal current	0 mA ... 1.5 mA
High level signal current	2 mA ... 10 mA
Input delay	< 0.2 ms
Electrical isolation	electronics for the field level
<b>Operating temperature</b>	0 to +55 °C



**BL20 electronic module**  
**4 digital inputs**  
**BL20-4DI-24VDC-P**

**Compatible base modules**

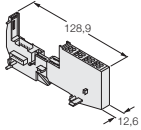
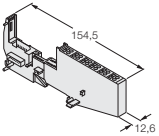
Dimensions	Type	Connection
	<b>6827046 BL20-S4T-SBBS</b> Tension spring connection	F198
	<b>6827047 BL20-S4S-SBBS</b> Screw connection	
Dimensions	Type	Connection
	<b>6827052 BL20-S6T-SBBSBB</b> Tension spring connection	F199
	<b>6827053 BL20-S6S-SBBSBB</b> Screw connection	

**Connection**

F198 - Wiring diagram

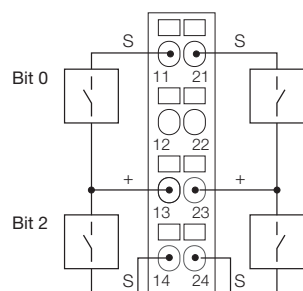

F199 - Wiring diagram

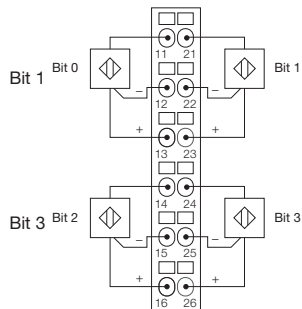

**BL20 electronic module**  
**4 digital inputs**  
**BL20-4DI-24VDC-N**

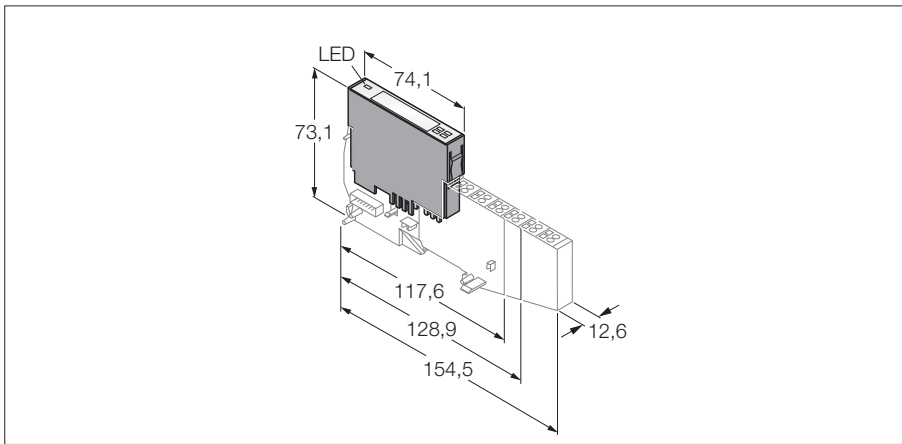

- Independent of the type of field-bus and connection technology used
- Degree of protection IP20
- LEDs for display of status and diagnostics
- Electronics galvanically isolated from the field level via opto-couplers
- 4 digital inputs, 24 VDC
- npn

<b>Type</b>	BL20-4DI-24VDC-N
Ident-No.	6827013
<b>Number of channels</b>	4
Rated voltage from the supply terminal	24 VDC
Rated current from field supply	≤ 40 mA
Rated current from module bus	≤ 28 mA
Power loss, typical	≤ 1 W
<b>Inputs</b>	
Input type	npn
Low level signal voltage	> 13 V
High level signal voltage	0 V ... +5 V
Low level signal current	0...1.2 mA
High level signal current	1.3...6 mA
Input delay	< 0.2 ms
Electrical isolation	electronics for the field level
<b>Operating temperature</b>	0 to +55 °C

**BL20 electronic module**  
**4 digital inputs**  
**BL20-4DI-24VDC-N**

**Compatible base modules**

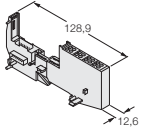
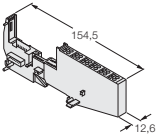
Dimensions	Type	Connection
	<b>6827046 BL20-S4T-SBBS</b> Tension spring connection	F200
	<b>6827047 BL20-S4S-SBBS</b> Screw connection	
Dimensions	Type	Connection
	<b>6827052 BL20-S6T-SBBSBB</b> Tension spring connection	F201
	<b>6827053 BL20-S6S-SBBSBB</b> Screw connection	

**Connection**

F200 - Wiring diagram

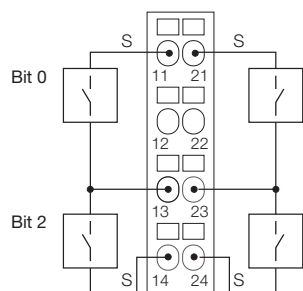

F201 - Wiring diagram

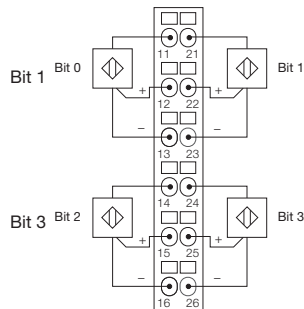

**BL20 electronic module**  
**4 digital inputs**  
**BL20-4DI-NAMUR**

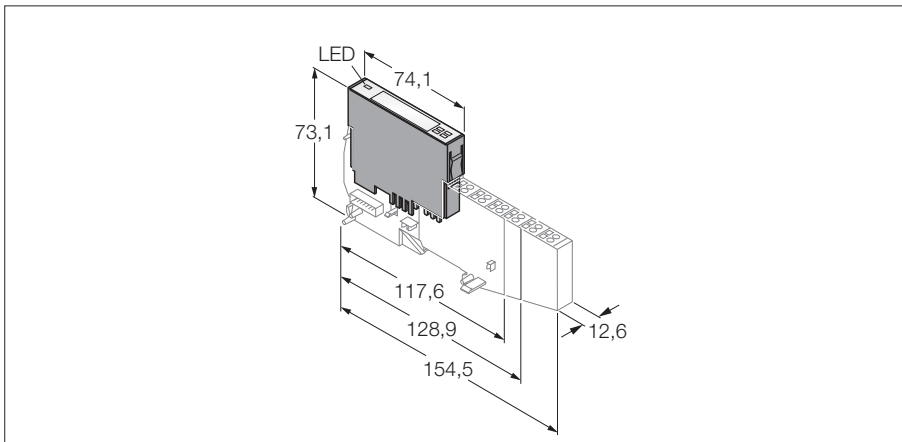

- Independent of the type of field-bus and connection technology used
- Degree of protection IP20
- LEDs for display of status and diagnostics
- Electronics galvanically isolated from the field level via opto-couplers
- 4 NAMUR inputs acc. to EN60947-5-6

<b>Type</b>	BL20-4DI-NAMUR
Ident-No.	6827212
<b>Number of channels</b>	4
Rated voltage from the supply terminal	24 VDC
Rated current from field supply	≤ 30 mA
Rated current from module bus	≤ 40 mA
Power loss, typical	≤ 1 W
<b>Inputs</b>	
Input type	NAMUR according to EN60947-5-6
No-load voltage	8.2 ... 8.6 VDC
Input - status	switch on threshold: 1.74 mA switch off threshold: 1.45 mA
Input wire-break	switch on threshold: 0.08 mA switch off threshold: 0.12 mA
Input - short-circuit	switch on threshold: 6.2 mA switch off threshold: 5.9 mA
Input delay	0.25 or 2.5 ms
Electrical isolation	electronics for the field level
<b>Operating temperature</b>	0 to +55 °C

**BL20 electronic module  
4 digital inputs  
BL20-4DI-NAMUR**

**Compatible base modules**

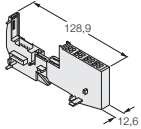
Dimensions	Type	Connection
	<p><b>6827046 BL20-S4T-SBBS</b> Tension spring connection</p>	<p>F200</p>
	<p><b>6827047 BL20-S4S-SBBS</b> Screw connection</p>	

**Connection**

F200 - Wiring diagram

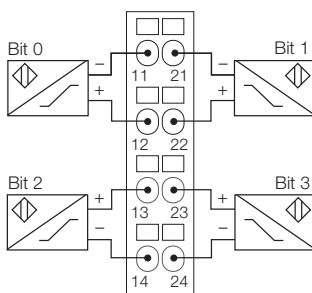

**BL20 Economy Module**  
**8 digital inputs**  
**BL20-E-8DI-24VDC-P**

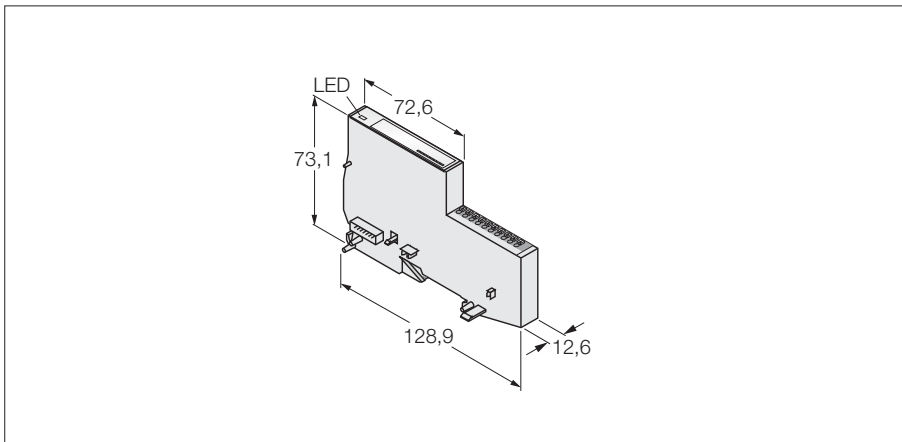

- Independent of the type of field-bus used
- Electronics and connection technology in a single housing
- Tension spring connection technology
- Degree of protection IP20
- LEDs for display of status and diagnostics
- Electronics galvanically isolated from the field level via opto-couplers
- 8 digital inputs, 24 VDC
- pnp

<b>Type</b>	BL20-E-8DI-24VDC-P
Ident-No.	6827227
<b>Number of channels</b>	8
Rated voltage from the supply terminal	24 VDC
Admissible range	18...30 VDC
Rated current from field supply	≤ 2 mA
Rated current from module bus	≤ 15 mA
Power loss, typical	≤ 1.5 W
<b>Inputs</b>	
Input type	pnp
Low level signal voltage	-30 V ... +5 V
High level signal voltage	11 V ... 30 V
Low level signal current	-1 mA ... 1.5 mA
High level signal current	2 mA ... 5 mA
Input delay	< 0.2 ms
Electrical isolation	electronics for the field level
<b>Operating temperature</b>	0 to +55 °C

**Terminal connection**

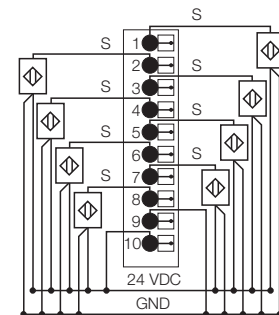

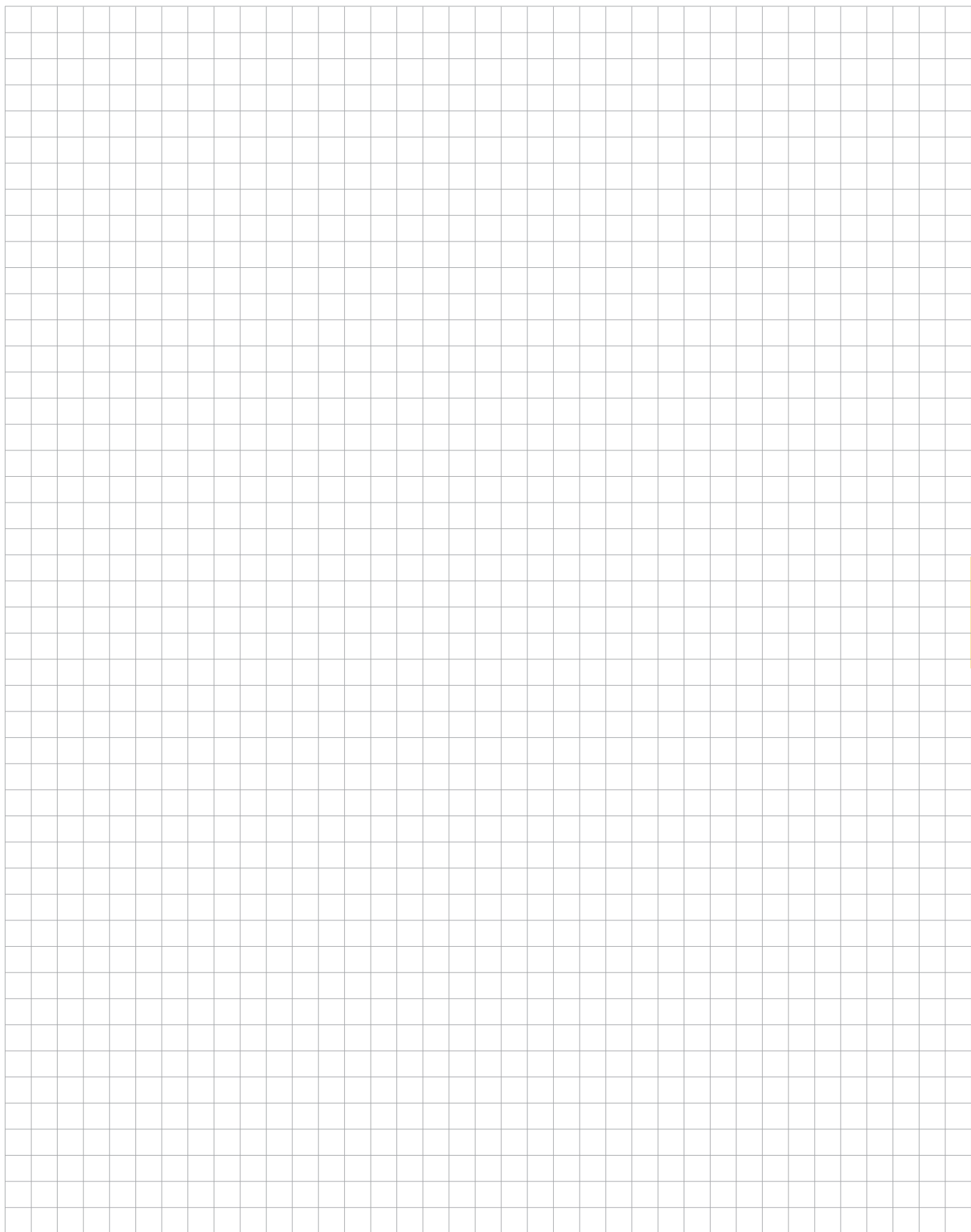

**BL20 electronic module**  
**16 digital inputs**  
**BL20-16DI-24VDC-P**

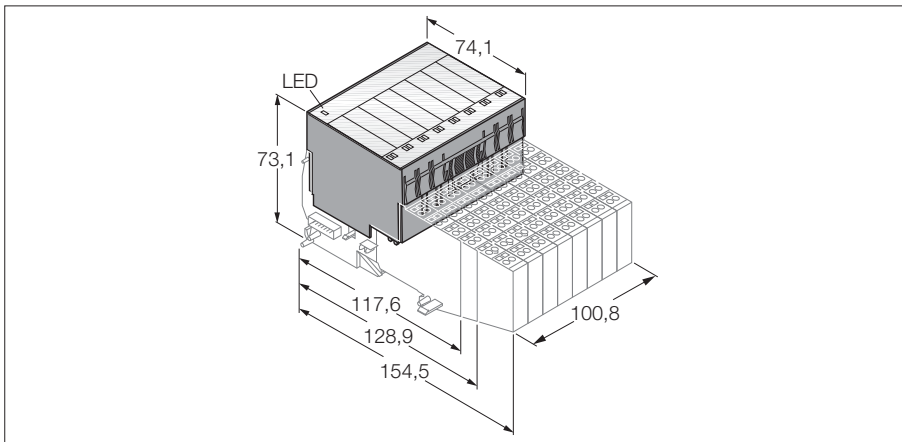

- Independent of the type of field-bus and connection technology used
- Degree of protection IP20
- LEDs for display of status and diagnostics
- Electronics galvanically isolated from the field level via opto-couplers
- 16 digital inputs, 24 VDC
- pnp

<b>Type</b>	BL20-16DI-24VDC-P
Ident-No.	6827014
<b>Number of channels</b>	16
Rated voltage from the supply terminal	24 VDC
Rated current from field supply	≤ 40 mA
Rated current from module bus	≤ 45 mA
Power loss, typical	≤ 2,5 W
<b>Inputs</b>	
Input type	pnp
Low level signal voltage	-30 V ... +5 V
High level signal voltage	15 V ... 30 V
Low level signal current	0 mA ... 1,5 mA
High level signal current	2 mA ... 10 mA
Input delay	< 0,2 ms
Electrical isolation	electronics for the field level
<b>Operating temperature</b>	0 to +55 °C



**BL20 electronic module  
16 digital inputs  
BL20-16DI-24VDC-P**

**Compatible base modules**

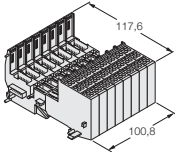
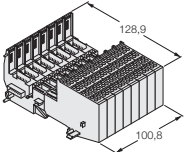
Dimensions	Type	Connection
	<b>6827054 BL20-B3T-SBB</b> Tension spring connection	F203
	<b>6827055 BL20-B3S-SBB</b> Screw connection	
Dimensions	Type	Connection
	<b>6827056 BL20-B4T-SBBC</b> Tension spring connection, access to C rail	F204
	<b>6827057 BL20-B4S-SBBC</b> Screw connection, access to C rail	

**Connection**

F203 - Wiring diagram

F204 - Wiring diagram

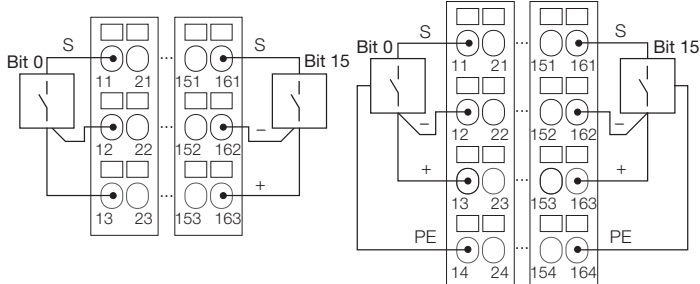

**BL20 Economy Module**  
**16 digital inputs**  
**BL20-E-16DI-24VDC-P**

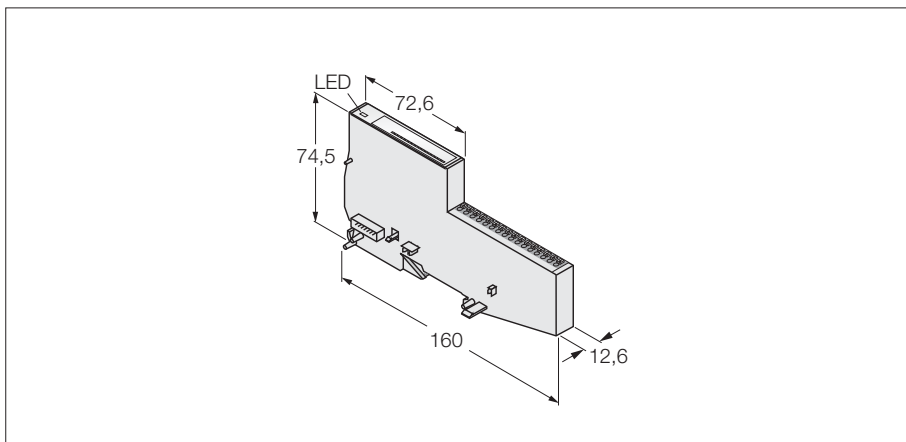

- Independent of the type of field-bus used
- Electronics and connection technology in a single housing
- Tension spring connection technology
- Degree of protection IP20
- LEDs for display of status and diagnostics
- Electronics galvanically isolated from the field level via opto-couplers
- 16 digital inputs, 24 VDC
- pnp

<b>Type</b>	BL20-E-16DI-24VDC-P
Ident-No.	6827231
<b>Number of channels</b>	16
Rated voltage from the supply terminal	24 VDC
Admissible range	18...30 VDC
Rated current from field supply	≤ 3 mA
Rated current from module bus	≤ 15 mA
Power loss, typical	≤ 1.5 W
<b>Inputs</b>	
Input type	pnp
Low level signal voltage	-30 V ... +5 V
High level signal voltage	11 V ... 30 V
Low level signal current	-1 mA ... 1.5 mA
High level signal current	2 mA ... 5 mA
Input delay	< 0.3 ms
Electrical isolation	electronics for the field level
<b>Operating temperature</b>	0 to +55 °C

**Terminal connection**

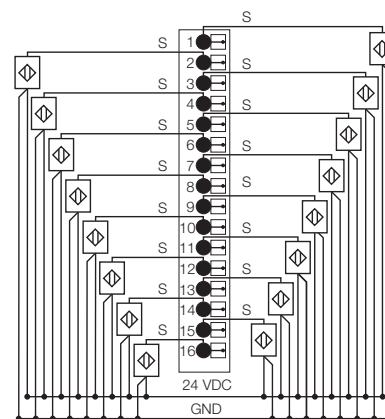

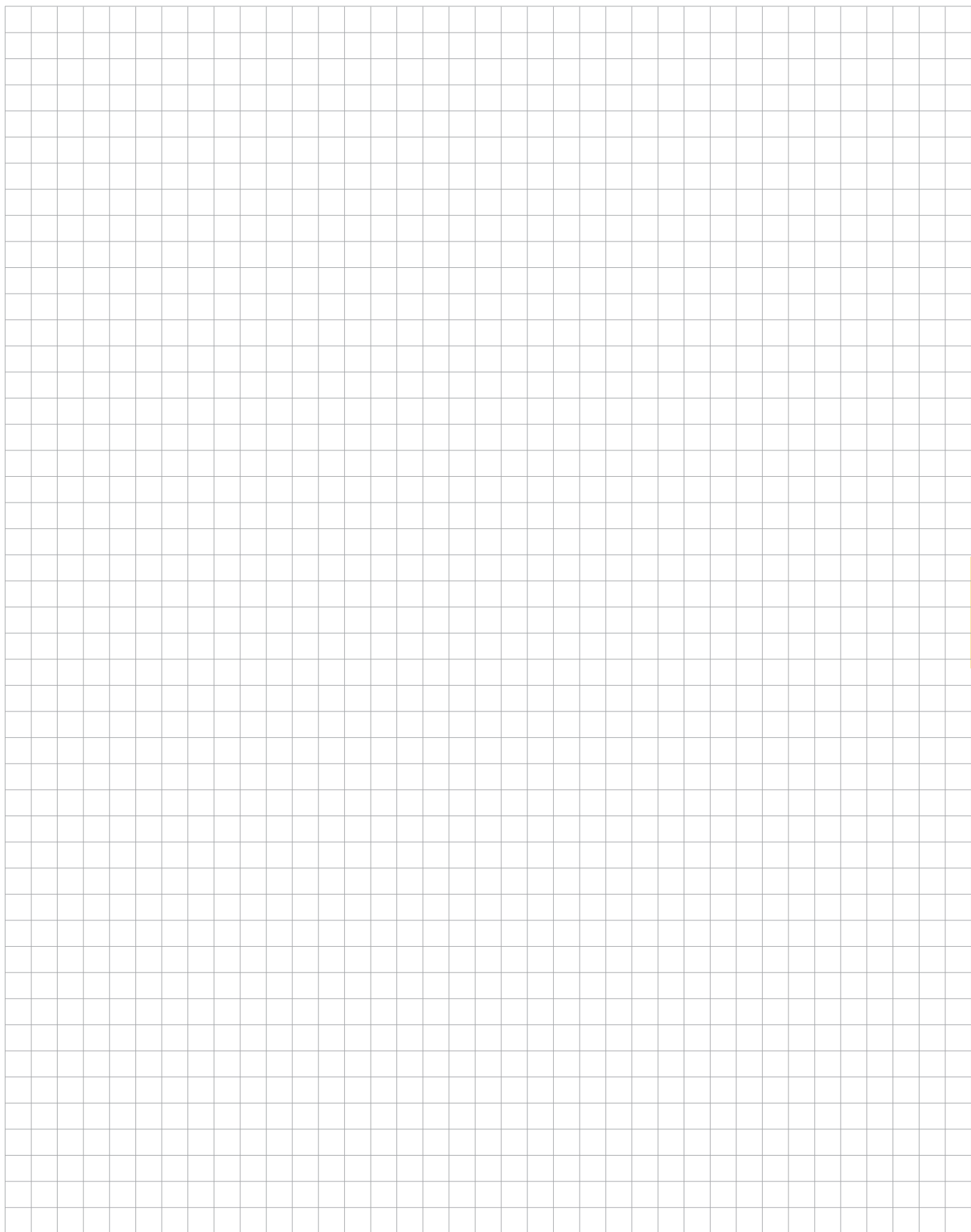

**BL20 electronic module**  
**32 digital inputs**  
**BL20-32DI-24VDC-P**

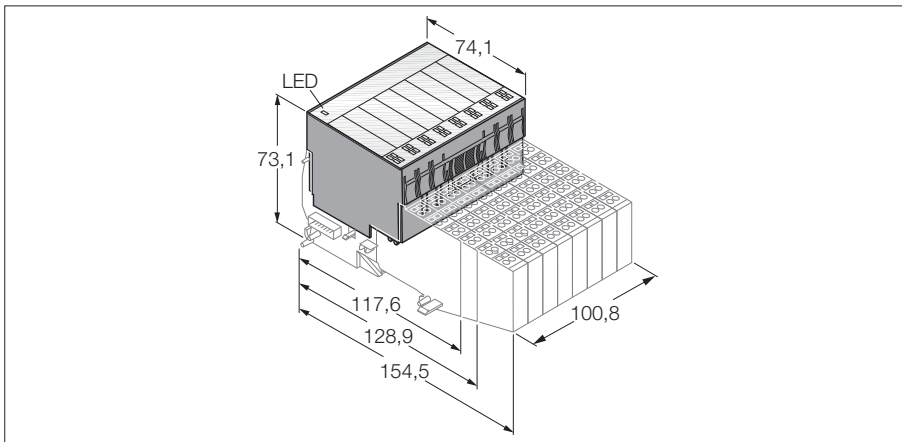

- Independent of the type of field-bus and connection technology used
- Degree of protection IP20
- LEDs for display of status and diagnostics
- Electronics galvanically isolated from the field level via opto-couplers
- 32 digital inputs, 24 VDC
- pnp

<b>Type</b>	BL20-32DI-24VDC-P
Ident-No.	6827015
<b>Number of channels</b>	32
Rated voltage from the supply terminal	24 VDC
Rated current from field supply	≤ 30 mA
Rated current from module bus	≤ 45 mA
Power loss, typical	≤ 4.2 W
<b>Inputs</b>	
Input type	pnp
Low level signal voltage	-30 V ... +5 V
High level signal voltage	15 V ... 30 V
Low level signal current	< 1.5 mA
High level signal current	2 mA ... 10 mA
Input delay	< 0.2 ms
Electrical isolation	electronics for the field level
<b>Operating temperature</b>	0 to +55 °C

**BL20 electronic module**  
**32 digital inputs**  
**BL20-32DI-24VDC-P**

**Compatible base modules**

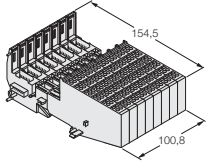
Dimensions	Type	Connection
	<b>6827065 BL20-B6T-SBBSBB</b> Tension spring connection	F205
	<b>6827067 BL20-B6S-SBBSBB</b> Screw connection	

**Connection**

F205 - Wiring diagram

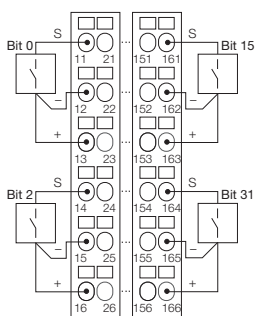

**BL20 electronic module**  
**1 analogue input**  
**BL20-1AI-I(0/4...20MA)**

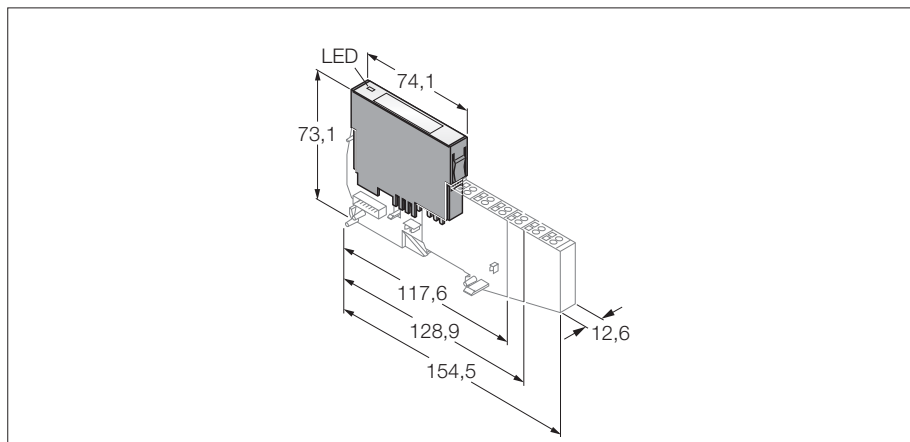

- Independent of the type of field-bus and connection technology used
- Degree of protection IP20
- LEDs for display of status and diagnostics
- Electronics galvanically isolated from the field level via opto-couplers
- 1 analogue input 0/4...20 mA

<b>Type</b>	BL20-1AI-I(0/4...20MA)
Ident-No.	6827018
<b>Number of channels</b>	1
Rated voltage from the supply terminal	24 VDC
Max. input current	50 mA
Rated current from field supply	≤ 50 mA
Rated current from module bus	≤ 41 mA
Power loss, typical	≤ 1 W
<b>Inputs</b>	
Input type	0/4...20 mA
Input resistance	< 0.125
Max. input current	50 mA
Electrical isolation	electronics for the field level
<b>Maximum limiting frequency, analogue</b>	< 200 Hz
Basic fault limit at 23 °C	< 0.2 %
Repeatability	0.09 %
Temperature coefficient	< 300 ppm/°C of full scale
Resolution	14 Bit
Measuring principle	successive approximation
Measured-value display	16 bit signed integer 12 bit full range left justified
<b>Number of diagnostic bytes</b>	1
Number of parameter bytes	1
<b>Operating temperature</b>	0 to +55 °C

**BL20 electronic module  
1 analogue input  
BL20-1AI-I(0/4...20MA)**

**Compatible base modules**

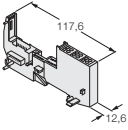
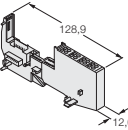
Dimensions	Type	Connection
	<b>6827044 BL20-S3T-SBB</b> Tension spring connection with external sensor supply	F206
	<b>6827045 BL20-S3S-SBB</b> Screw connection with external sensor supply	
Dimensions	Type	Connection
	<b>6827046 BL20-S4T-SBBS</b> Tension spring connection	F207, F208, F209
	<b>6827047 BL20-S4S-SBBS</b> Screw connection	

**Connection**

F206 - Wiring diagram

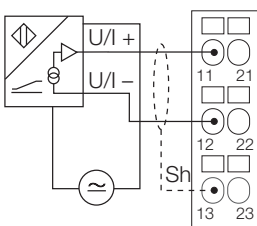

F207 - 2-wire technology

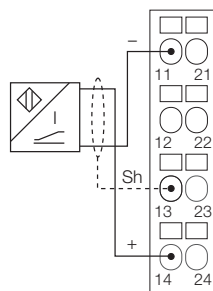

F208 - 3-wire technology

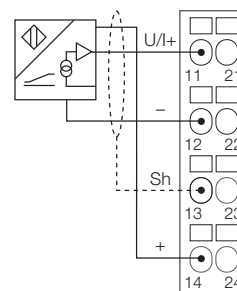

F209 - 4-wire technology

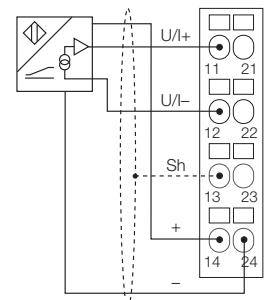

**BL20 electronic module**  
**1 analogue input**  
**BL20-1AI-U(-10/0...+10VDC)**

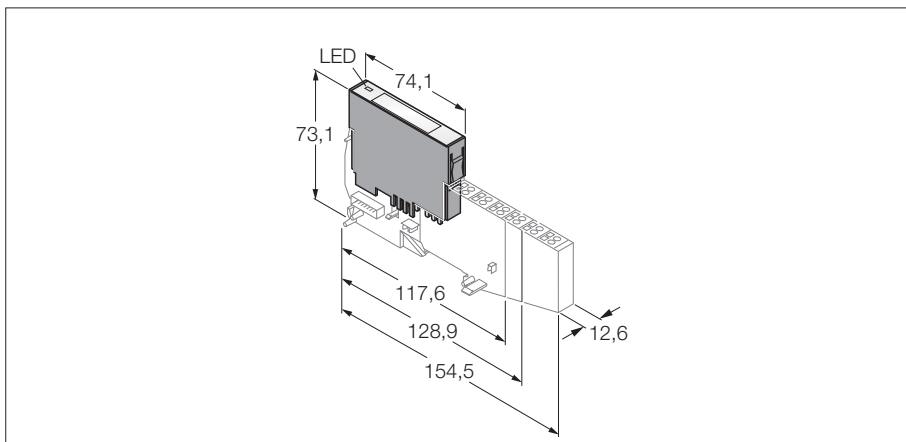

- Independent of the type of field-bus and connection technology used
- Degree of protection IP20
- LEDs for display of status and diagnostics
- Electronics galvanically isolated from the field level via opto-couplers
- 1 analogue input -10/0...+10 VDC

<b>Type</b>	BL20-1AI-U(-10/0...+10VDC)
Ident-No.	6827019
<b>Number of channels</b>	1
Rated voltage from the supply terminal	24 VDC
Rated current from field supply	≤ 50 mA
Rated current from module bus	≤ 41 mA
Power loss, typical	≤ 1 W
<b>Inputs</b>	
Input type	-10/0...+10 VDC
Input resistance	< 98,5
Max. input voltage	35 V dauernd
Electrical isolation	electronics for the field level
<b>Maximum limiting frequency, analogue</b>	< 200 Hz
Basic fault limit at 23 °C	< 0.2 %
Repeatability	0.05 %
Temperature coefficient	< 300 ppm/°C of full scale
Resolution	14 Bit
Measuring principle	successive approximation
Measured-value display	16 bit signed integer 12 bit signed integer left-justified 12 bit full range left justified
<b>Number of diagnostic bytes</b>	1
Number of parameter bytes	1
<b>Operating temperature</b>	0 to +55 °C



**BL20 electronic module  
1 analogue input  
BL20-1AI-U(-10/0...+10VDC)**

**Compatible base modules**

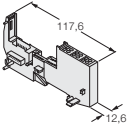
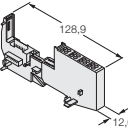
Dimensions	Type	Connection
	<b>6827044 BL20-S3T-SBB</b> Tension spring connection with external sensor supply	F206
	<b>6827045 BL20-S3S-SBB</b> Screw connection with external sensor supply	
Dimensions	Type	Connection
	<b>6827046 BL20-S4T-SBBS</b> Tension spring connection	F207, F208, F209
	<b>6827047 BL20-S4S-SBBS</b> Screw connection	

**Connection**

F206 - Wiring diagram

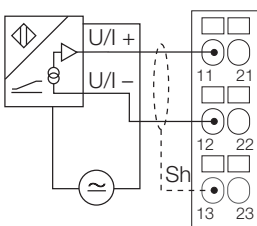

F207 - 2-wire technology

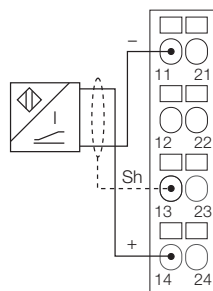

F208 - 3-wire technology

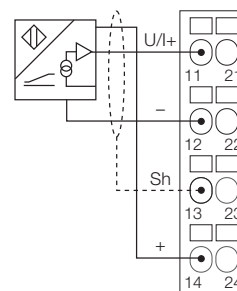

F209 - 4-wire technology

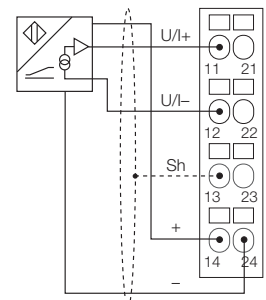

**BL20 electronic module**  
**2 analogue inputs**  
**BL20-2AI-I(0/4...20MA)**

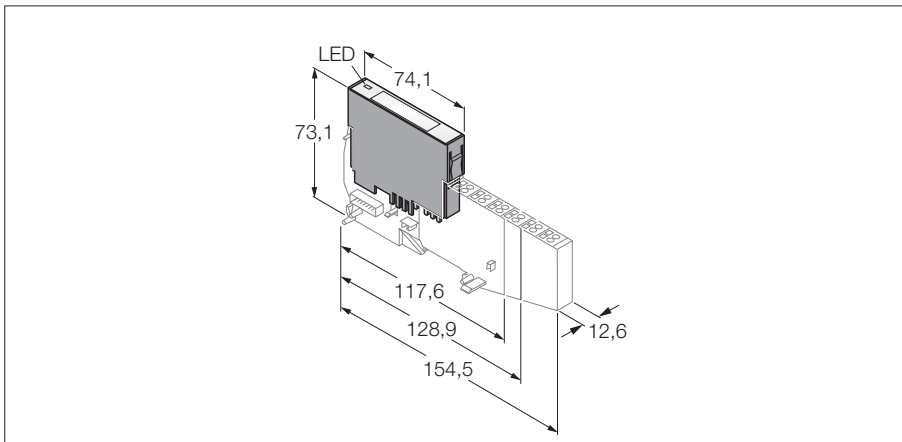

- Independent of the type of field-bus and connection technology used
- Degree of protection IP20
- LEDs for display of status and diagnostics
- Electronics galvanically isolated from the field level via opto-couplers
- 2 analogue inputs 0/4...20 mA

<b>Type</b>	BL20-2AI-I(0/4...20MA)
Ident-No.	6827021
<b>Number of channels</b>	2
Rated voltage from the supply terminal	24 VDC
Max. input current	50 mA
Rated current from field supply	≤ 12 mA
Rated current from module bus	≤ 35 mA
Power loss, typical	≤ 1 W
<b>Inputs</b>	
Input type	0/4...20 mA
Input resistance	< 0.125
Max. input current	50 mA
Electrical isolation	electronics for the field level
<b>Maximum limiting frequency, analogue</b>	< 50 Hz
Basic fault limit at 23 °C	< 0.2 %
Repeatability	0.05 %
Temperature coefficient	< 300 ppm/°C of full scale
Resolution	16 Bit
Measuring principle	Delta Sigma
Measured-value display	16 bit signed integer 12 bit full range left justified
<b>Number of diagnostic bytes</b>	2
Number of parameter bytes	2
<b>Operating temperature</b>	0 to +55 °C

**BL20 electronic module**  
**2 analogue inputs**  
**BL20-2AI-I(0/4...20MA)**

**Compatible base modules**

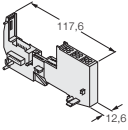
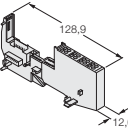
Dimensions	Type	Connection
	<b>6827044 BL20-S3T-SBB</b> Tension spring connection with external sensor supply	F210
	<b>6827045 BL20-S3S-SBB</b> Screw connection with external sensor supply	
Dimensions	Type	Connection
	<b>6827046 BL20-S4T-SBBS</b> Tension spring connection	F211, F212
	<b>6827047 BL20-S4S-SBBS</b> Screw connection	

**Connection**

F210 - Wiring diagram

F211 - 2-wire technology

F212 - 3-wire technology

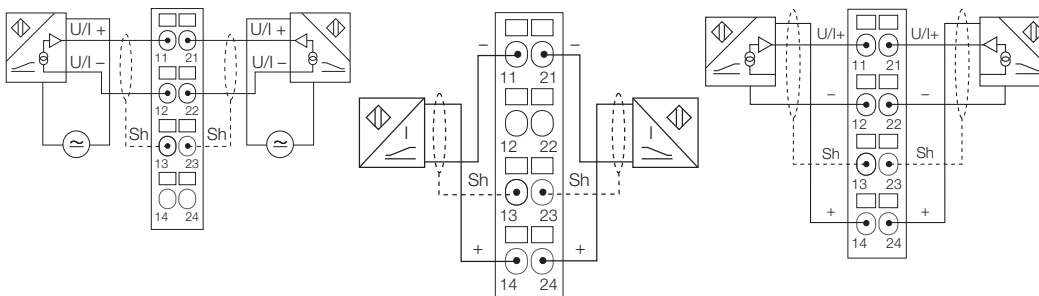

**BL20 electronic module**  
**2 analogue inputs**  
**BL20-2AI-U(-10/0...+10VDC)**

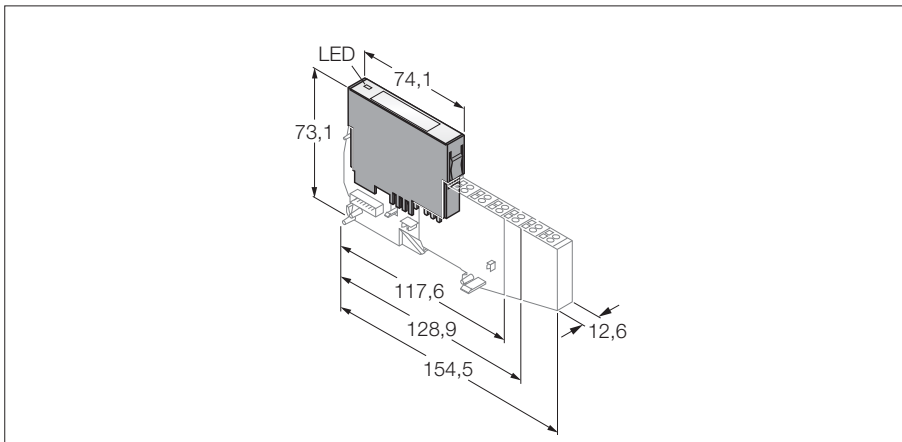

- Independent of the type of field-bus and connection technology used
- Degree of protection IP20
- LEDs for display of status and diagnostics
- Electronics galvanically isolated from the field level via opto-couplers
- 2 analogue input -10/0...+10 VDC

<b>Type</b>	BL20-2AI-U(-10/0...+10VDC)
Ident-No.	6827022
<b>Number of channels</b>	2
Rated voltage from the supply terminal	24 VDC
Rated current from field supply	≤ 12 mA
Rated current from module bus	≤ 35 mA
Power loss, typical	≤ 1 W
<b>Inputs</b>	
Input type	-10/0...+10 VDC
Input resistance	< 98,5
Max. input voltage	35 V constant
Electrical isolation	electronics for the field level
<b>Maximum limiting frequency, analogue</b>	< 50 Hz
Basic fault limit at 23 °C	< 0.2 %
Repeatability	0.05 %
Temperature coefficient	< 150 ppm/°C of full scale
Resolution	16 Bit
Measuring principle	Delta Sigma
Measured-value display	16 bit signed integer 12 bit full range left justified
<b>Number of diagnostic bytes</b>	2
Number of parameter bytes	2
<b>Operating temperature</b>	0 to +55 °C

**BL20 electronic module**  
**2 analogue inputs**  
**BL20-2AI-U(-10/0...+10VDC)**

**Compatible base modules**

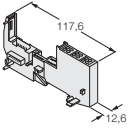
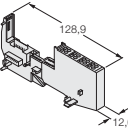
Dimensions	Type	Connection
	<b>6827044 BL20-S3T-SBB</b> Tension spring connection with external sensor supply	F210
	<b>6827045 BL20-S3S-SBB</b> Screw connection with external sensor supply	
Dimensions	Type	Connection
	<b>6827046 BL20-S4T-SBBS</b> Tension spring connection	F211, F212
	<b>6827047 BL20-S4S-SBBS</b> Screw connection	

**Connection**

F210 - Wiring diagram

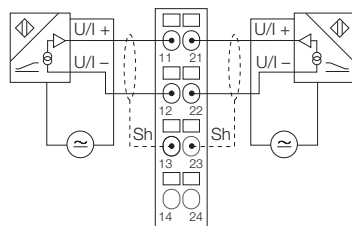

F211 - 2-wire technology

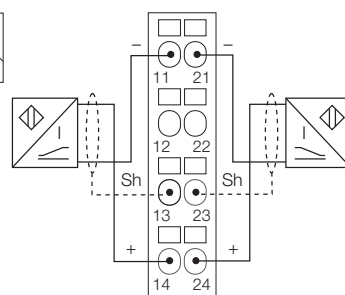

F212 - 3-wire technology

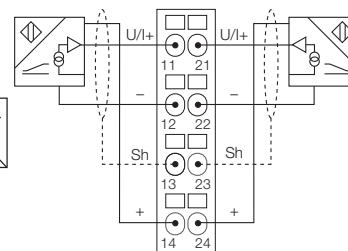

**BL20 electronic module**  
**2 analogue inputs for temperature measurement**  
**BL20-2AI-PT/Ni-2/3**

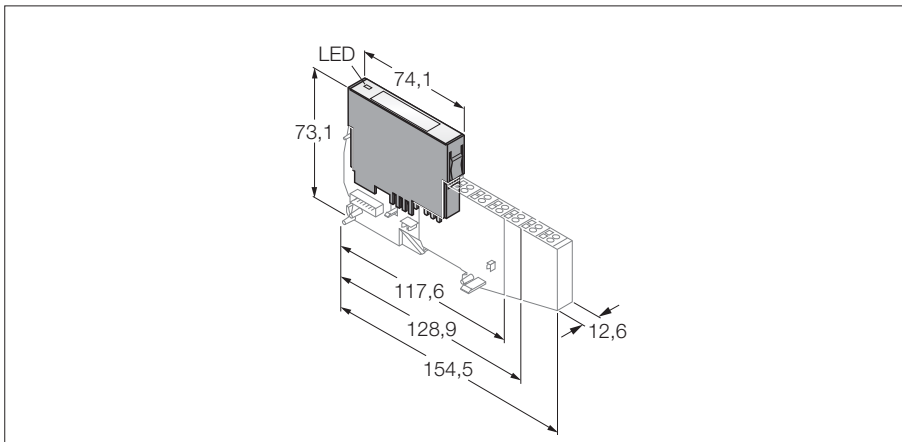

- Independent of the type of field-bus and connection technology used
- Degree of protection IP20
- LEDs for display of status and diagnostics
- Electronics galvanically isolated from the field level via opto-couplers
- 2 analogue inputs for PT100, PT500 and PT1000 as well as for Ni100 and Ni1000

<b>Type</b>	BL20-2AI-PT/Ni-2/3
Ident-No.	6827017
<b>Number of channels</b>	2
Rated voltage from the supply terminal	24 VDC
Rated current from field supply	≤ 30 mA
Rated current from module bus	≤ 45 mA
Power loss, typical	≤ 1 W
<b>Inputs</b>	
Input type	PT100, PT500, PT1000, Ni100, Ni1000
Electrical isolation	electronics for the field level
<b>Basic fault limit at 23 °C</b>	< 0.2 %
Repeatability	0.05 %
Temperature coefficient	< 300 ppm/°C of full scale
Resolution	16 Bit
Measured-value display	16 bit signed integer 12 bit full range left justified
Cycle time	≤ 130 ms
Measuring current	< 1 mA
<b>Number of diagnostic bytes</b>	2
Number of parameter bytes	4
<b>Operating temperature</b>	0 to +55 °C

**BL20 electronic module**  
**2 analogue inputs for temperature measurement**  
**BL20-2AI-PT/NI-2/3**

**Compatible base modules**

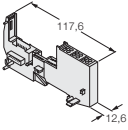
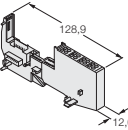
Dimensions	Type	Connection
	<b>6827044 BL20-S3T-SBB</b> Tension spring connection	F213
	<b>6827045 BL20-S3S-SBB</b> Screw connection	
Dimensions	Type	Connection
	<b>6827046 BL20-S4T-SBBS</b> Tension spring connection	F214
	<b>6827047 BL20-S4S-SBBS</b> Screw connection	

**Connection**

F213 - 2-wire technology

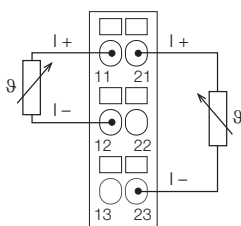

F214 - 3-wire technology

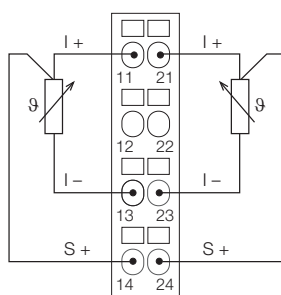

**BL20 electronic module**  
**2 analogue inputs for temperature measurement**  
**BL20-2AI-THERMO-PI**

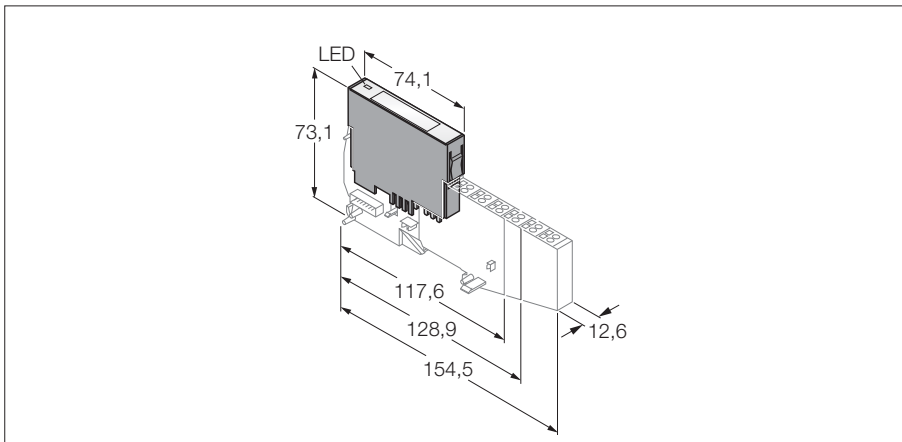

- Independent of the type of field-bus and connection technology used
- Degree of protection IP20
- LEDs for display of status and diagnostics
- Electronics galvanically isolated from the field level via opto-couplers
- 2 analogue inputs for connection of thermoelements, types B, E, J, K, N, R, S and T
- Base module with internal cold junction point compensation

<b>Type</b>	BL20-2AI-THERMO-PI
Ident-No.	6827020
<b>Number of channels</b>	2
Rated voltage from the supply terminal	24 VDC
Rated current from field supply	≤ 30 mA
Rated current from module bus	≤ 45 mA
Power loss, typical	≤ 1 W
<b>Inputs</b>	
Input type	types B, E, J, K, N, R, S, T
Electrical isolation	electronics for the field level
<b>Voltage resolution</b>	+50mV: < 2μV
Basic fault limit at 23 °C	< 0.2 %
Repeatability	0.05 %
Temperature coefficient	< 300 ppm/°C of full scale
Resolution	16 Bit
Measured-value display	16 bit signed integer 12 bit full range left justified
Cycle time	≤ 60 ms
<b>Number of diagnostic bytes</b>	2
Number of parameter bytes	2
<b>Operating temperature</b>	0 to +55 °C



**BL20 electronic module**  
**2 analogue inputs for temperature measurement**  
**BL20-2AI-THERMO-PI**

**Compatible base modules**

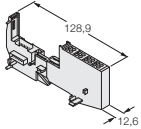
Dimensions	Type	Connection
	<b>6827048 BL20-S4T-SBBS-CJ</b> Tension spring connection	F215
	<b>6827049 BL20-S4S-SBBS-CJ</b> Screw connection	

**Connection**

F215 - Wiring diagram

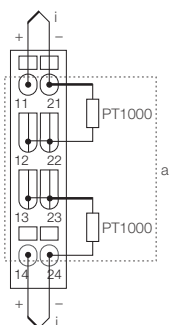

**BL20 electronic module**  
**4 analogue inputs**  
**BL20-4AI-U/I**

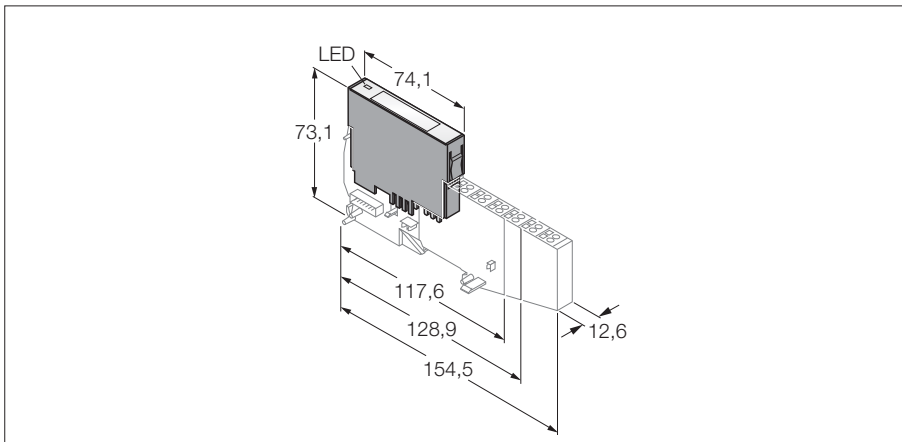

- Independent of the type of field-bus and connection technology used
- Degree of protection IP20
- LEDs for display of status and diagnostics
- Electronics galvanically isolated from the field level via opto-couplers
- 4 analogue inputs
- 0/4...20 mA or 10/0...+10 VDC
- Selectable per channel

<b>Type</b>	BL20-4AI-U/I
Ident-No.	6827217
<b>Number of channels</b>	4
Rated voltage from the supply terminal	24 VDC
Max. input current	50 mA
Rated current from field supply	≤ 20 mA
Rated current from module bus	≤ 50 mA
Power loss, typical	≤ 1 W
<b>Inputs</b>	
Input type	0/4 ... 20 mA or -10/0 ... +10 VDC
Input resistance	< 0.062 bzw > 98.5
Max. input current	50 mA
Max. input voltage	35 V constant
Electrical isolation	electronics for the field level
<b>Maximum limiting frequency, analogue</b>	< 20 Hz
Basic fault limit at 23 °C	< 0.3 %
Repeatability	0.05 %
Temperature coefficient	< 300 ppm/°C of full scale
Resolution	16 Bit
Measuring principle	Delta Sigma
<b>Number of diagnostic bytes</b>	4
Number of parameter bytes	4
<b>Operating temperature</b>	0 to +55 °C

**BL20 electronic module**  
**4 analogue inputs**  
**BL20-4AI-U/I**

**Compatible base modules**

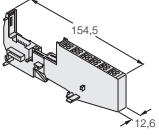
Dimensions	Type	Connection
	<b>6827064 BL20-S6T-SBCSBC</b> Tension spring connection	F216, F217, F218
	<b>6827066 BL20-S6S-SBCSBC</b> Screw connection	

**Connection**

**F216 - 2-wire technology**

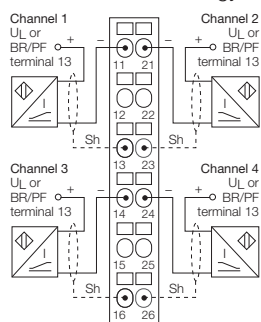

**F217 - 3-wire technology**

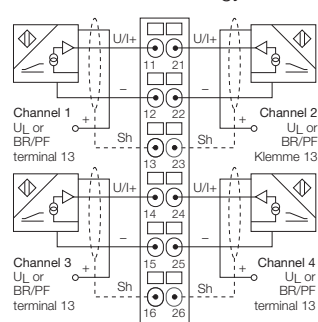

**F218 - 4-wire technology**

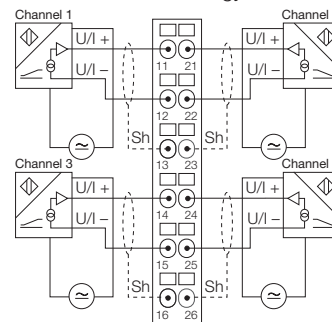

**BL20 electronic module**  
**2 digital outputs**  
**BL20-2DO-24VDC-0,5A-P**

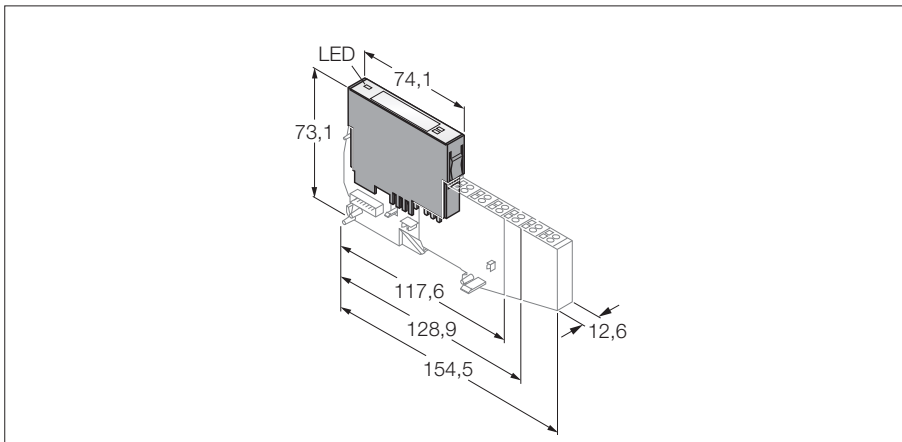

- Independent of the type of field-bus and connection technology used
- Degree of protection IP20
- LEDs for display of status and diagnostics
- Electronics galvanically isolated from the field level via opto-couplers
- 2 digital outputs, 24 VDC
- 0.5 A max.
- pnp

<b>Type</b>	BL20-2DO-24VDC-0,5A-P
Ident-No.	6827024
<b>Number of channels</b>	2
Rated voltage from the supply terminal	24 VDC
Rated current from field supply	≤ 20 mA
Rated current from module bus	≤ 32 mA
Power loss, typical	≤ 1 W
<b>Outputs</b>	
Output type	pnp
Output voltage	24 VDC
Output current per channel	0.5 A
Output delay	0.1 ms
Load type	resistive, inductive, lamp load
Load resistance, resistive	> 48 Ω
Load resistance, inductive	< 1.2 H
Lamp load	< 3 W
Switching frequency, resistive	< 5000 Hz
Switching frequency, lamp load	< 10 Hz
Short-circuit protection	yes
Simultaneity factor	1
Electrical isolation	electronics for the field level
<b>Number of diagnostic bits</b>	2
<b>Operating temperature</b>	0 to +55 °C

**BL20 electronic module**  
**2 digital outputs**  
**BL20-2DO-24VDC-0,5A-P**

**Compatible base modules**

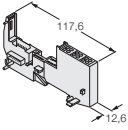
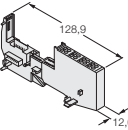
Dimensions	Type	Connection
	<b>6827058 BL20-S3T-SBC</b> Tension spring connection, access to C rail	F219
	<b>6827059 BL20-S3S-SBC</b> Screw connection, access to C rail	
Dimensions	Type	Connection
	<b>6827063 BL20-S4T-SBCS</b> Tension spring connection, access to C rail	F220
	<b>6827060 BL20-S4S-SBCS</b> Screw connection, access to C rail	

**Connection**

F219 - Wiring diagram

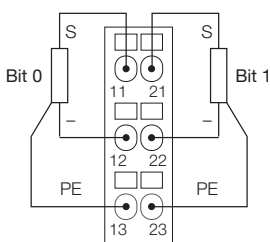

F220 - Wiring diagram

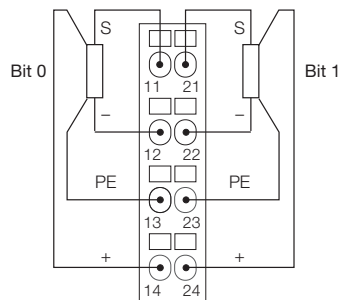

**BL20 electronic module**  
**2 digital outputs**  
**BL20-2DO-24VDC-0,5A-N**

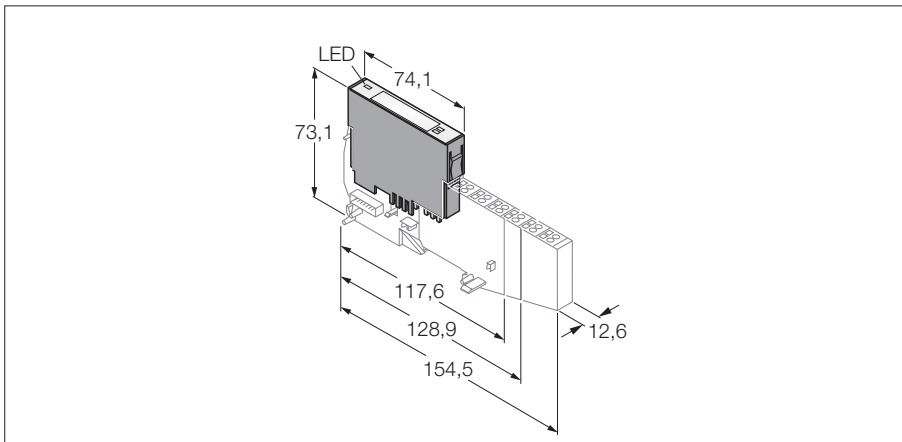

- Independent of the type of field-bus and connection technology used
- Degree of protection IP20
- LEDs for display of status and diagnostics
- Electronics galvanically isolated from the field level via opto-couplers
- 2 digital outputs, 24 VDC
- 0.5 A max.
- npn

<b>Type</b>	BL20-2DO-24VDC-0,5A-N
Ident-No.	6827025
<b>Number of channels</b>	2
Rated voltage from the supply terminal	24 VDC
Rated current from field supply	≤ 20 mA
Rated current from module bus	≤ 32 mA
Power loss, typical	≤ 1 W
<b>Outputs</b>	
Output type	npn
Output voltage	24 VDC
Output current per channel	0.5 A
Output delay	0.1 ms
Load type	resistive, inductive, lamp load
Load resistance, resistive	> 48 Ω
Load resistance, inductive	< 1.2 H
Lamp load	< 12 W
Switching frequency, resistive	< 100 Hz
Inductive switching frequency	< 2 Hz
Switching frequency, lamp load	< 10 Hz
Short-circuit protection	yes
Simultaneity factor	1
Electrical isolation	electronics for the field level
<b>Number of diagnostic bits</b>	2
<b>Operating temperature</b>	0 to +55 °C

**BL20 electronic module**  
**2 digital outputs**  
**BL20-2DO-24VDC-0,5A-N**

**Compatible base modules**

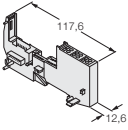
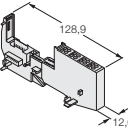
Dimensions	Type	Connection
	<b>6827058 BL20-S3T-SBC</b> Tension spring connection, access to C rail	F221
	<b>6827059 BL20-S3S-SBC</b> Screw connection, access to C rail	
Dimensions	Type	Connection
	<b>6827063 BL20-S4T-SBCS</b> Tension spring connection, access to C rail	F222
	<b>6827060 BL20-S4S-SBCS</b> Screw connection, access to C rail	

**Connection**

F221 - Wiring diagram

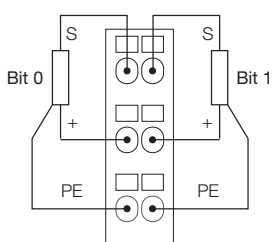

F222 - Wiring diagram

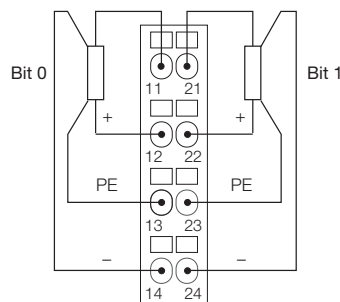

**BL20 electronic module**  
**2 digital outputs**  
**BL20-2DO-24VDC-2A-P**

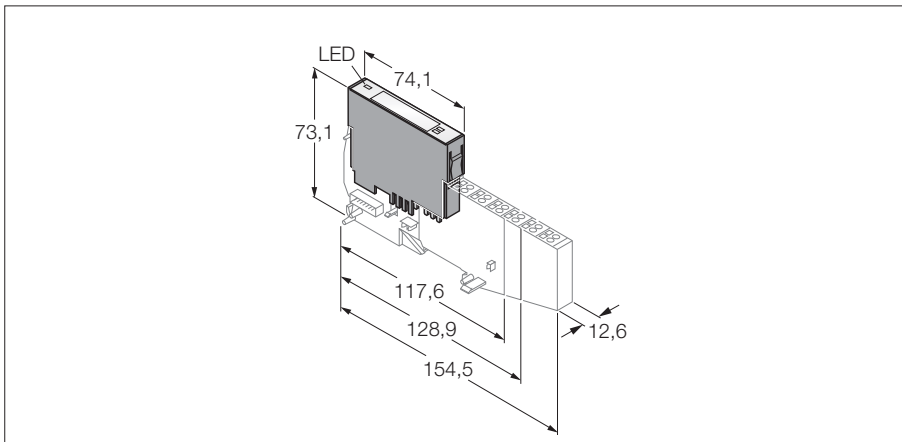

- Independent of the type of field-bus and connection technology used
- Degree of protection IP20
- LEDs for display of status and diagnostics
- Electronics galvanically isolated from the field level via opto-couplers
- 2 digital outputs, 24 VDC
- 2 A max.
- pnp

<b>Type</b>	BL20-2DO-24VDC-2A-P
Ident-No.	6827026
<b>Number of channels</b>	2
Rated voltage from the supply terminal	24 VDC
Rated current from field supply	≤ 50 mA
Rated current from module bus	≤ 33 mA
Power loss, typical	≤ 1 W
<b>Outputs</b>	
Output type	pnp
Output voltage	24 VDC
Output current per channel	2 A
Output delay	0.1 ms
Load type	resistive, inductive, lamp load
Load resistance, resistive	> 12 Ω
Load resistance, inductive	< 1.2 H
Lamp load	< 6 W
Switching frequency, resistive	< 5000 Hz
Switching frequency, lamp load	< 10 Hz
Short-circuit protection	yes
Simultaneity factor	1
Electrical isolation	electronics for the field level
<b>Number of diagnostic bits</b>	2
<b>Operating temperature</b>	0 to +55 °C



**BL20 electronic module**  
**2 digital outputs**  
**BL20-2DO-24VDC-2A-P**

**Compatible base modules**

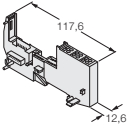
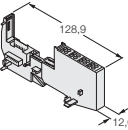
Dimensions	Type	Connection
	<b>6827058 BL20-S3T-SBC</b> Tension spring connection, access to C rail	F219
	<b>6827059 BL20-S3S-SBC</b> Screw connection, access to C rail	
Dimensions	Type	Connection
	<b>6827063 BL20-S4T-SBCS</b> Tension spring connection, access to C rail	F220
	<b>6827060 BL20-S4S-SBCS</b> Screw connection, access to C rail	

**Connection**

F219 - Wiring diagram

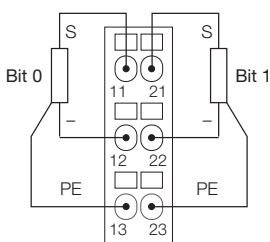

F220 - Wiring diagram

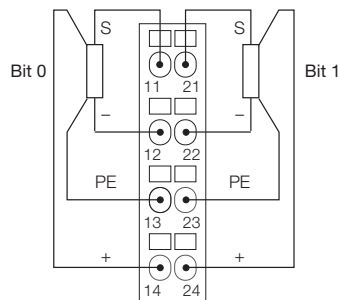

**BL20 electronic module**  
**2 digital outputs**  
**BL20-2DO-120/230VAC-0,5A**

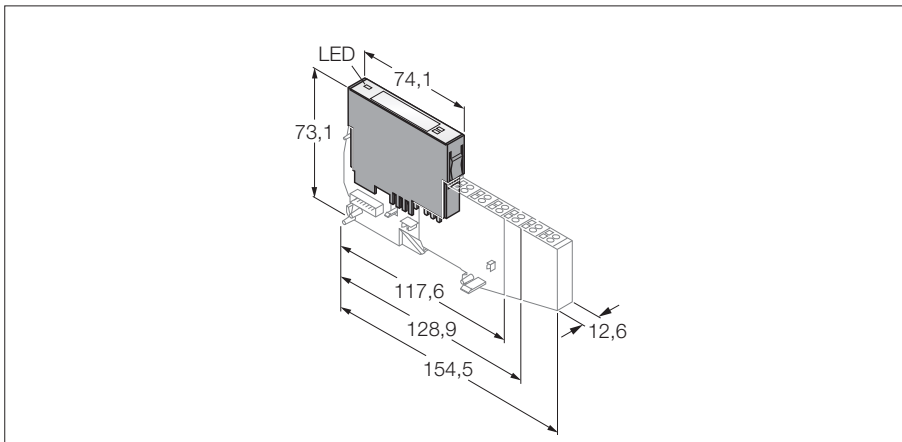

- Independent of the type of field-bus and connection technology used
- Degree of protection IP20
- LEDs for display of status and diagnostics
- Electronics galvanically isolated from the field level via opto-couplers
- 2 digital outputs, 120/230 VAC
- 0.5 A max.

<b>Type</b>	BL20-2DO-120/230VAC-0,5A
Ident-No.	6827137
<b>Number of channels</b>	2
Rated voltage from the supply terminal	120 / 230 VAC
Rated current from field supply	≤ 20 mA
Rated current from module bus	≤ 35 mA
Power loss, typical	≤ 1 W
<b>Outputs</b>	
Output voltage	120 / 230 VAC
Output current per channel	0.5 A
Output delay	0.1 ms
Load type	resistive, inductive, lamp load
Load resistance, resistive	> 48 Ω
Load resistance, inductive	< 1.2 H
Short-circuit protection	yes
Simultaneity factor	1
Electrical isolation	electronics for the field level
<b>Number of diagnostic bits</b>	2
<b>Operating temperature</b>	0 to +55 °C

**BL20 electronic module  
2 digital outputs  
BL20-2DO-120/230VAC-0,5A**

**Compatible base modules**

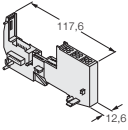
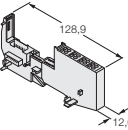
Dimensions	Type	Connection
	<b>6827058 BL20-S3T-SBC</b> Tension spring connection, access to C rail	F219
	<b>6827059 BL20-S3S-SBC</b> Screw connection, access to C rail	
Dimensions	Type	Connection
	<b>6827063 BL20-S4T-SBCS</b> Tension spring connection, access to C rail	F220
	<b>6827060 BL20-S4S-SBCS</b> Screw connection, access to C rail	

**Connection**

F219 - Wiring diagram

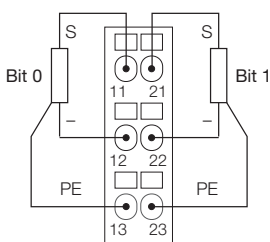

F220 - Wiring diagram

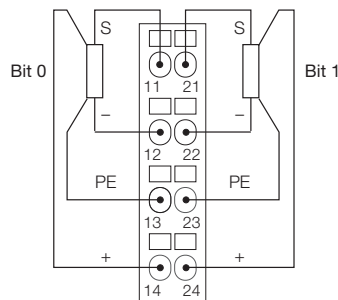

**BL20 electronic module**  
**relay module, 2 x normally open**  
**BL20-2DO-R-NO**

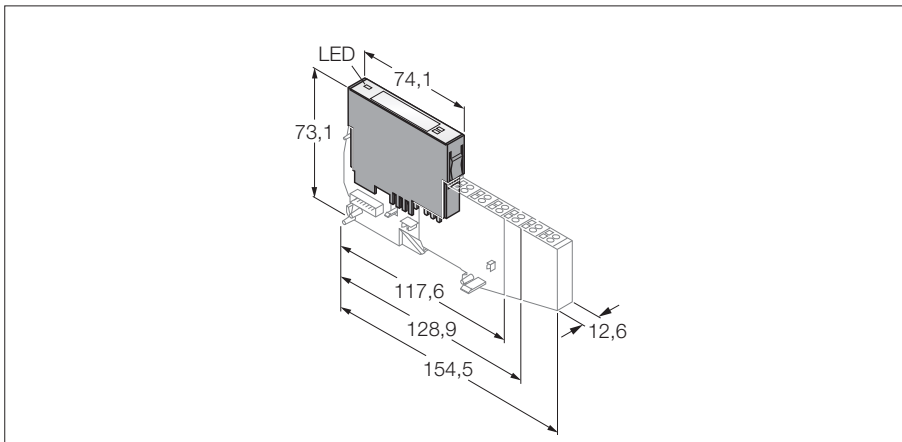

- Independent of the type of field-bus and connection technology used
- Degree of protection IP20
- LEDs for display of status and diagnostics
- Electronics galvanically isolated from the field level via opto-couplers
- 2 normally open channels

<b>Type</b>	BL20-2DO-R-NO
Ident-No.	6827029
<b>Number of channels</b>	2, normally open
Rated voltage from the supply terminal	24 VDC
Rated current from field supply	≤ 20 mA
Rated current from module bus	≤ 28 mA
Power loss, typical	≤ 1 W
<b>Outputs</b>	
Load type	resistive, inductive, lamp load
Rated load voltage	230/30 VAC/DC
Simultaneity factor	1
Life at 230 VAC, 5A	100000
Life at 230 VAC, 0.5A	1000000
Output current with DC voltage (resistive)	see load limit curve
Electrical isolation	electronics for the field level
<b>Operating temperature</b>	0 to +55 °C

**Load limit curve**

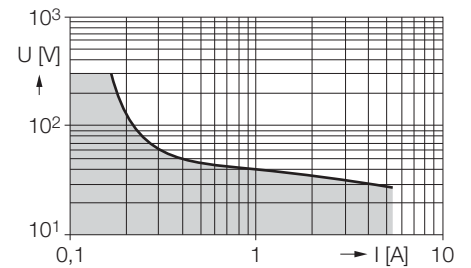

**BL20 electronic module  
relay module, 2 x normally open  
BL20-2DO-R-NO**

**Compatible base modules**

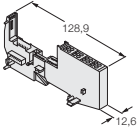
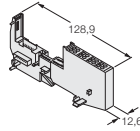
Dimensions	Type	Connection
	<p><b>6827046 BL20-S4T-SBBS</b> Tension spring connection</p> <p><b>6827047 BL20-S4S-SBBS</b> Screw connection</p> <p>With externally applied supply and cross connected root</p> <p>1) Jumpered in the electronics</p> <p>2) cross-connection via QVR in the base</p>	F223, F225
	<p><b>6827063 BL20-S4T-SBCS</b> Tension spring connection</p> <p><b>6827060 BL20-S4S-SBCS</b> Screw connection</p> <p>With supply via C rail and cross connected root</p> <p>1) C rail</p> <p>2) cross-connection via QVR in the base; max. 8 relay modules</p>	F224, F226

**Connection**

F223 - Wiring diagram

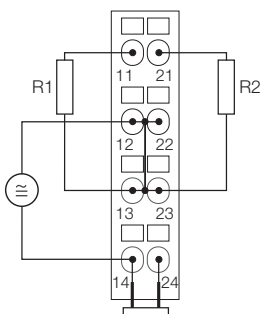

F224 - Wiring diagram

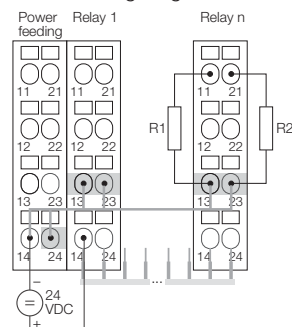

F225 - module wiring diagram

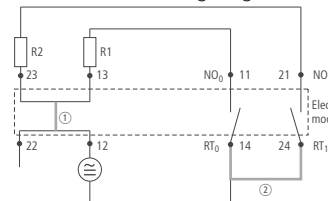

F226 - module wiring diagram

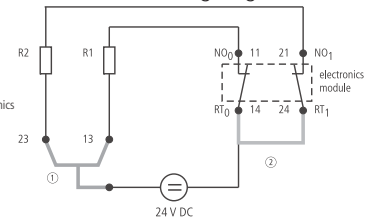

**BL20 electronic module**  
**relay module, 2 x normally closed**  
**BL20-2DO-R-NC**

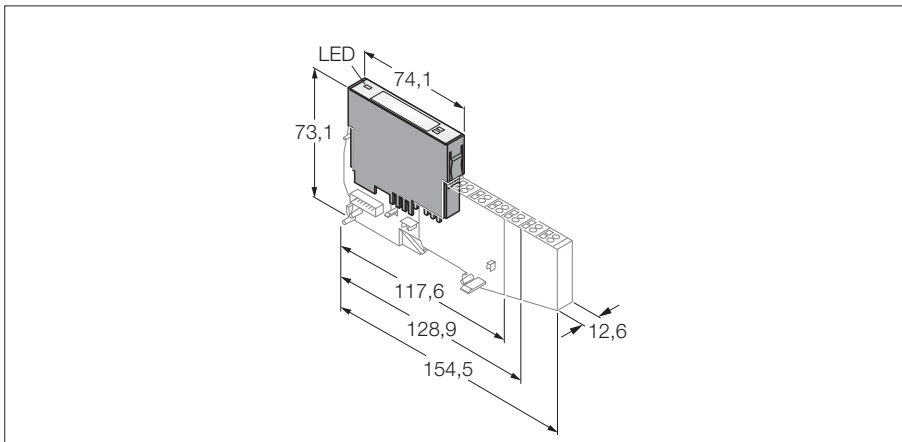

- Independent of the type of field-bus and connection technology used
- Degree of protection IP20
- LEDs for display of status and diagnostics
- Electronics galvanically isolated from the field level via opto-couplers
- 2 normally closed channels

<b>Type</b>	BL20-2DO-R-NC
Ident-No.	6827028
<b>Number of channels</b>	2, normally closed
Rated voltage from the supply terminal	24 VDC
Rated current from field supply	≤ 20 mA
Rated current from module bus	≤ 28 mA
Power loss, typical	≤ 1 W
<b>Outputs</b>	
Load type	resistive, inductive, lamp load
Rated load voltage	230/30 VAC/DC
Simultaneity factor	1
Life at 230 VAC, 5A	100000
Life at 230 VAC, 0.5A	1000000
Output current with DC voltage (resistive)	see load limit curve
Electrical isolation	electronics for the field level
<b>Operating temperature</b>	0 to +55 °C

**Load limit curve**

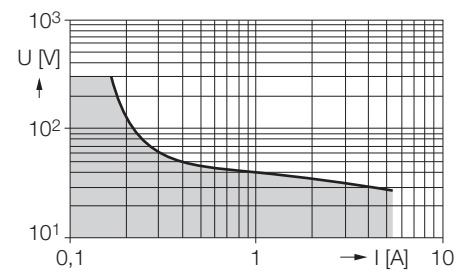

**BL20 electronic module  
relay module, 2 x normally closed  
BL20-2DO-R-NC**

**Compatible base modules**

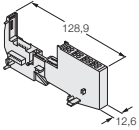
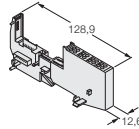
Dimensions	Type	Connection
	<b>6827046 BL20-S4T-SBBS</b> Tension spring connection	F223, F225
	<b>6827047 BL20-S4S-SBBS</b> Screw connection  With externally applied supply and cross connected root 1) Jumpered in the electronics 2) cross-connection via QVR in the base	
Dimensions	Type	Connection
	<b>6827063 BL20-S4T-SBCS</b> Tension spring connection	F224, F226
	<b>6827060 BL20-S4S-SBCS</b> Screw connection  With supply via C rail and cross connected root 1) C rail 2) cross-connection via QVR in the base; max. 8 relay modules	

**Connection**

F223 - Wiring diagram

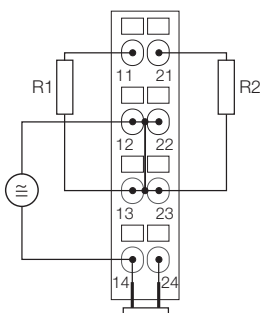

F224 - Wiring diagram

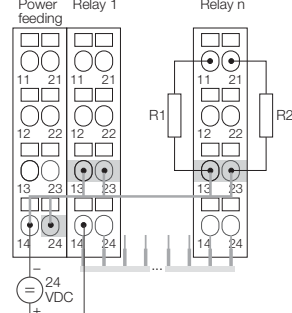

F227 - module wiring diagram

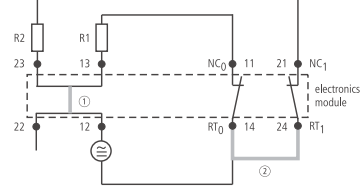

F228 - module wiring diagram

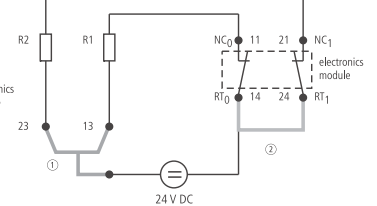

**BL20 electronic module**  
**relay module, 2 x change-over**  
**BL20-2DO-R-CO**

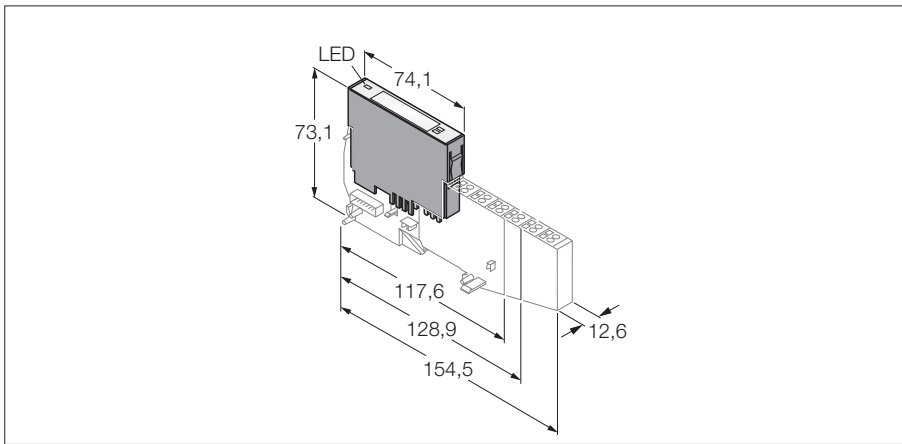

- Independent of the type of field-bus and connection technology used
- Degree of protection IP20
- LEDs for display of status and diagnostics
- Electronics galvanically isolated from the field level via opto-couplers
- 2 change-over channels

<b>Type</b>	BL20-2DO-R-CO
Ident-No.	6827030
<b>Number of channels</b>	2, change-over, galvanically isolated
Rated voltage from the supply terminal	24 VDC
Rated current from field supply	≤ 20 mA
Rated current from module bus	≤ 28 mA
Power loss, typical	≤ 1 W
<b>Outputs</b>	
Load type	resistive, inductive, lamp load
Rated load voltage	230/30 VAC/DC
Simultaneity factor	1
Life at 230 VAC, 5A	100000
Life at 230 VAC, 0.5A	1000000
Output current with DC voltage (resistive)	see load limit curve
Electrical isolation	electronics for the field level
<b>Operating temperature</b>	0 to +55 °C

**Load limit curve**

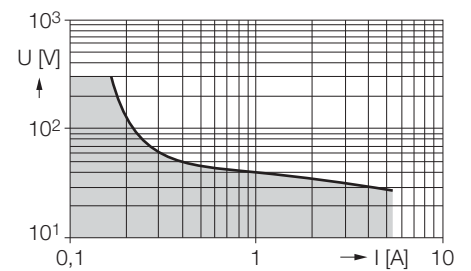



**BL20 electronic module  
relay module, 2 x change-over  
BL20-2DO-R-CO**

**Compatible base modules**

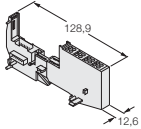
Dimensions	Type	Connection
	<b>6827046 BL20-S4T-SBBS</b> Tension spring connection	F229, F230
	<b>6827047 BL20-S4S-SBBS</b> Screw connection	

**Connection**

F229 - Wiring diagram

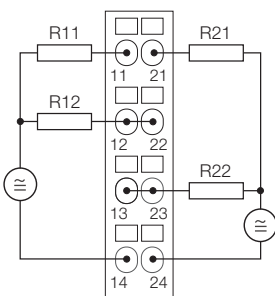

F230 - module wiring diagram

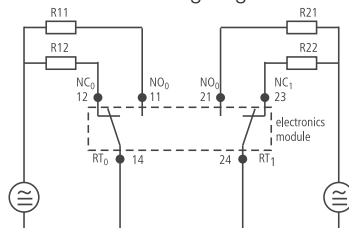

**BL20 electronic module**  
**4 digital outputs**  
**BL20-4DO-24VDC-0,5A-P**

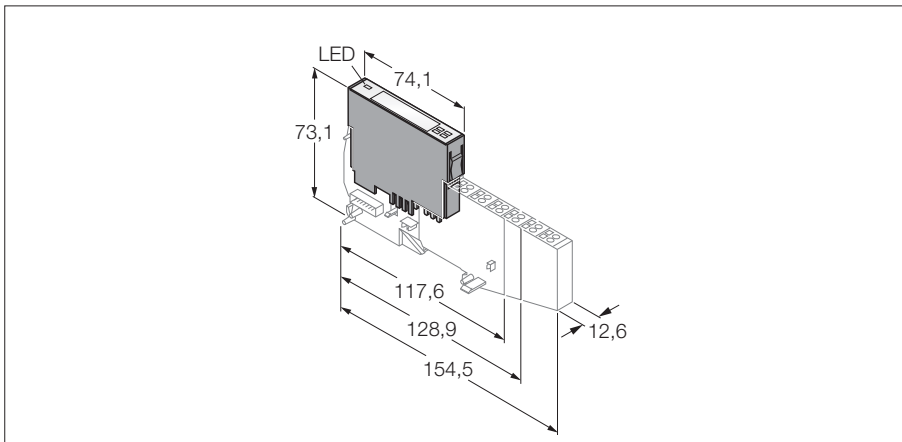

- Independent of the type of field-bus and connection technology used
- Degree of protection IP20
- LEDs for display of status and diagnostics
- Electronics galvanically isolated from the field level via opto-couplers
- 4 digital outputs, 24 VDC
- 0.5 A max.
- pnp

<b>Type</b>	BL20-4DO-24VDC-0,5A-P
Ident-No.	6827023
<b>Number of channels</b>	4
Rated voltage from the supply terminal	24 VDC
Rated current from field supply	≤ 25 mA
Rated current from module bus	≤ 30 mA
Power loss, typical	≤ 1 W
<b>Outputs</b>	
Output type	pnp
Output voltage	24 VDC
Output current per channel	0.5 A
Output delay	0.25 ms
Load type	resistive, inductive, lamp load
Load resistance, resistive	> 48 Ω
Load resistance, inductive	< 1.2 H
Lamp load	< 6 W
Switching frequency, resistive	< 5000 Hz
Inductive switching frequency	< 2 Hz
Switching frequency, lamp load	< 10 Hz
Short-circuit protection	yes
Simultaneity factor	1
Electrical isolation	electronics for the field level
<b>Number of diagnostic bits</b>	1
<b>Operating temperature</b>	0 to +55 °C

**BL20 electronic module  
4 digital outputs  
BL20-4DO-24VDC-0,5A-P**

**Compatible base modules**

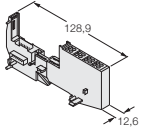
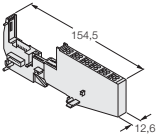
Dimensions	Type	Connection
	<b>6827063 BL20-S4T-SBCS</b> Tension spring connection, access to C rail	F231
	<b>6827060 BL20-S4S-SBCS</b> Screw connection, access to C rail	
Dimensions	Type	Connection
	<b>6827064 BL20-S6T-SBCSBC</b> Tension spring connection, access to C rail	F232
	<b>6827066 BL20-S6S-SBCSBC</b> Screw connection, access to C rail	

**Connection**

F231 - Wiring diagram

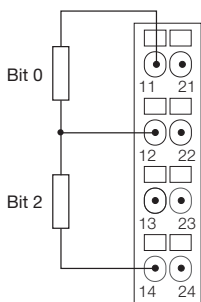

F232 - Wiring diagram

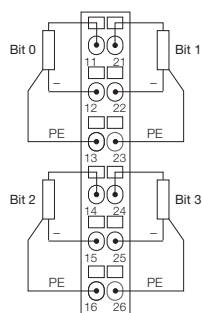

**BL20 Economy Module**  
**8 digital outputs**  
**BL20-E-8DO-24VDC-0,5A-P**

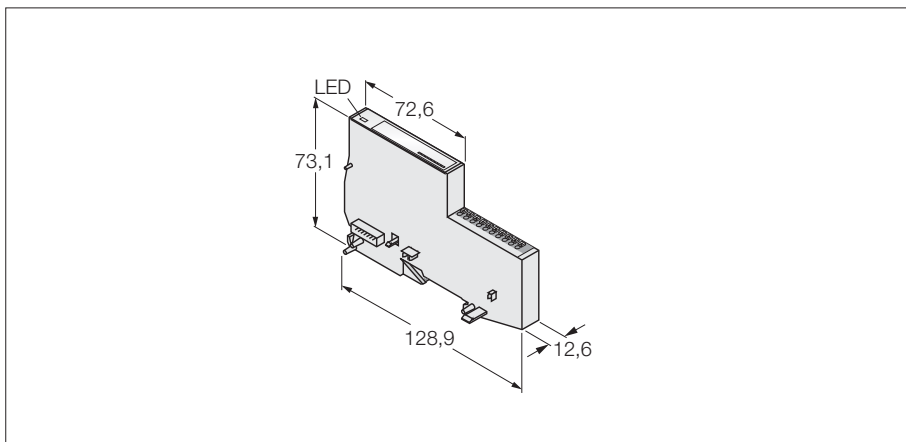

- Independent of the type of field-bus used
- Electronics and connection technology in a single housing
- Tension spring connection technology
- Degree of protection IP20
- LEDs for display of status and diagnostics
- Electronics galvanically isolated from the field level via opto-couplers
- 8 digital outputs, 24 VDC
- 0.5 A max.
- pnp

<b>Type</b>	BL20-E-8DO-24VDC-0,5A-P
Ident-No.	6827226
<b>Number of channels</b>	8
Rated voltage from the supply terminal	24 VDC
Admissible range	18...30 VDC
Rated current from field supply	≤ 3 mA
Rated current from module bus	≤ 15 mA
Power loss, typical	≤ 1.5 W
<b>Outputs</b>	
Output type	pnp
Output voltage	24 VDC
Output current per channel	0.5 A
Output delay	0.3 ms
Load type	resistive, inductive, lamp load
Load resistance, resistive	> 48 Ω
Lamp load	< 6 W
Switching frequency, resistive	< 100 Hz
Switching frequency, lamp load	< 10 Hz
Short-circuit protection	yes
Simultaneity factor	1
Electrical isolation	electronics for the field level
<b>Operating temperature</b>	0 to +55 °C

**Terminal connection**

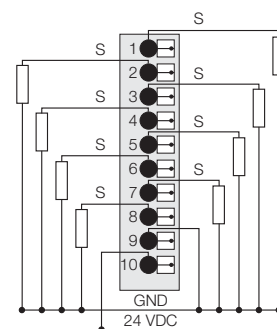

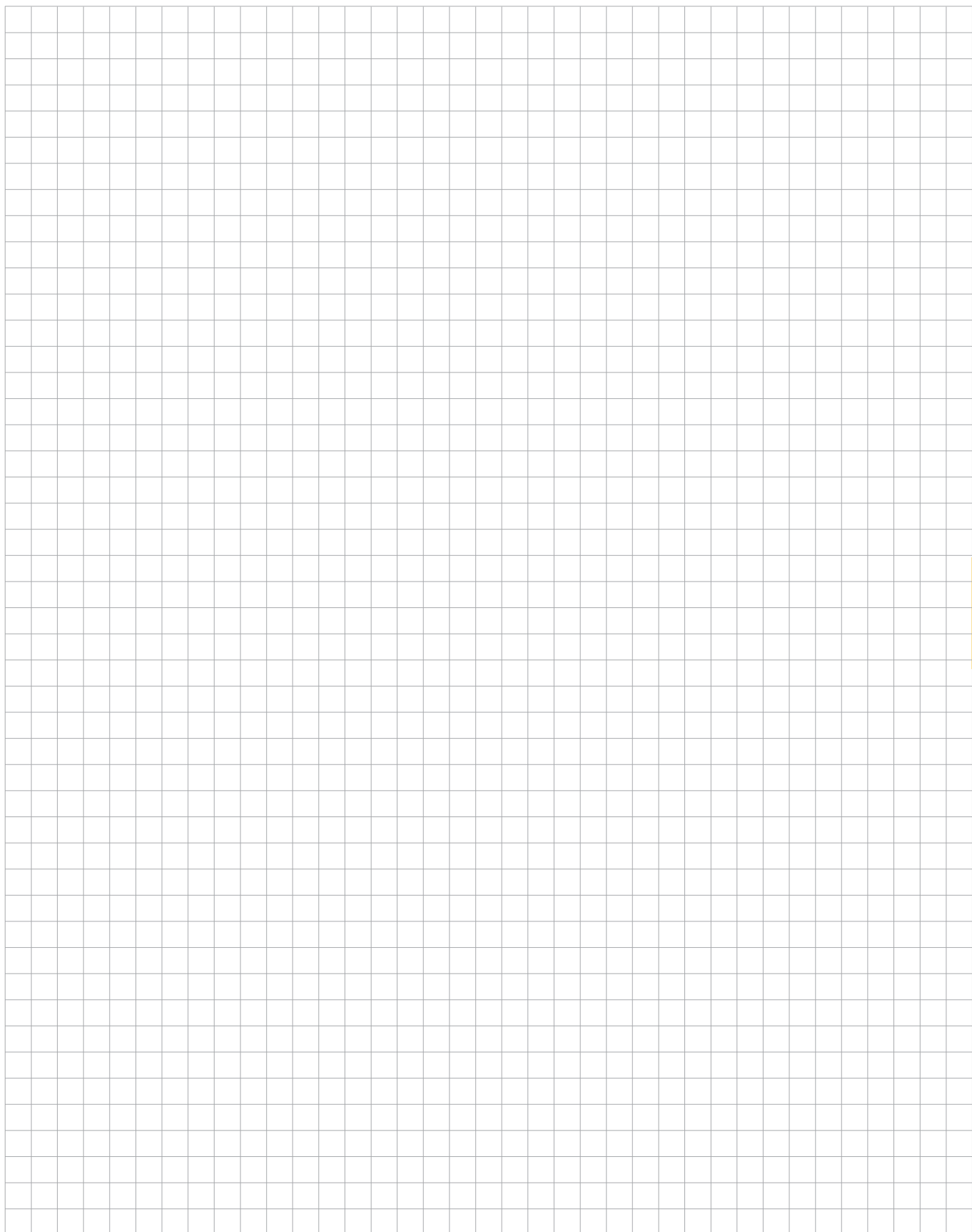

**BL20 electronic module**  
**16 digital outputs**  
**BL20-16DO-24VDC-0,5A-P**

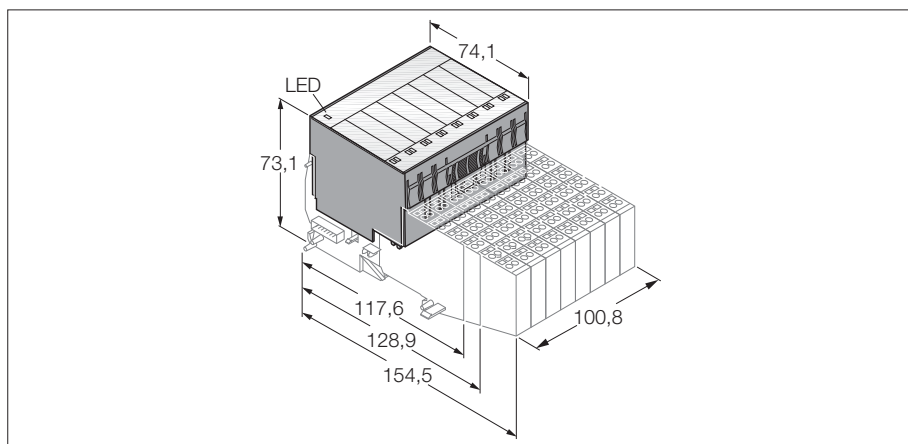

- Independent of the type of field-bus and connection technology used
- Degree of protection IP20
- LEDs for display of status and diagnostics
- Electronics galvanically isolated from the field level via opto-couplers
- 16 digital outputs, 24 VDC
- 0.5 A max.
- pnp

<b>Type</b>	BL20-16DO-24VDC-0,5A-P
Ident-No.	6827027
<b>Number of channels</b>	16
Rated voltage from the supply terminal	24 VDC
Rated current from field supply	≤ 50 mA
Rated current from module bus	≤ 120 mA
Power loss, typical	≤ 4 W
<b>Outputs</b>	
Output type	pnp
Output voltage	24 VDC
Output current per channel	0.5 A
Output delay	0.1 ms
Load type	resistive, inductive, lamp load
Load resistance, resistive	> 48 Ω
Load resistance, inductive	< 1.2 H
Lamp load	< 3 W
Switching frequency, resistive	< 100 Hz
Short-circuit protection	yes
Simultaneity factor	1
Electrical isolation	electronics for the field level
<b>Number of diagnostic bits</b>	4
<b>Operating temperature</b>	0 to +55 °C

**BL20 electronic module**  
**16 digital outputs**  
**BL20-16DO-24VDC-0,5A-P**

**Compatible base modules**

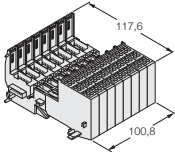
Dimensions	Type	Connection
	<p><b>6827061 BL20-B3T-SBC</b>                      Tension spring connection, access to C rail</p> <p><b>6827062 BL20-B3S-SBC</b>                      Screw connection, access to C rail</p>	<p>F233</p>

**Connection**

F233 - Wiring diagram

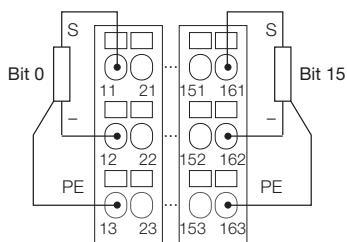

**BL20 Economy Module**  
**16 digital outputs**  
**BL20-E-16DO-24VDC-0,5A-P**

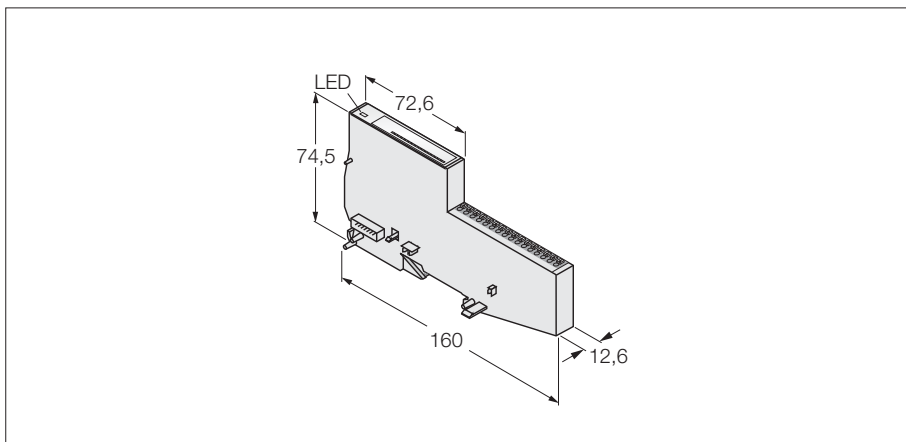

- Independent of the type of field-bus used
- Electronics and connection technology in a single housing
- Tension spring connection technology
- Degree of protection IP20
- LEDs for display of status and diagnostics
- Electronics galvanically isolated from the field level via opto-couplers
- 16 digital outputs, 24 VDC
- 0.5 A max.
- pnp

<b>Type</b>	BL20-E-16DO-24VDC-0,5A-P
Ident-No.	6827230
<b>Number of channels</b>	16
Rated voltage from the supply terminal	24 VDC
Admissible range	18...30 VDC
Rated current from field supply	≤ 3 mA
Rated current from module bus	≤ 25 mA
Power loss, typical	≤ 1.5 W
<b>Outputs</b>	
Output type	pnp
Output voltage	24 VDC
Output current per channel	0.5 A
Output delay	0.3 ms
Load type	resistive, inductive, lamp load
Load resistance, resistive	> 48 Ω
Lamp load	< 6 W
Switching frequency, resistive	< 100 Hz
Switching frequency, lamp load	< 10 Hz
Short-circuit protection	yes
Simultaneity factor	0.5
Electrical isolation	electronics for the field level
<b>Operating temperature</b>	0 to +55 °C

**Terminal connection**

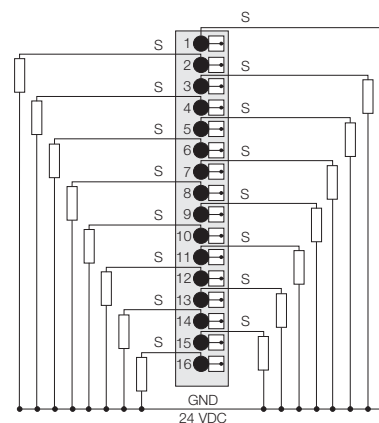





**BL20 electronic module**  
**32 digital outputs**  
**BL20-32DO-24VDC-0,5A-P**

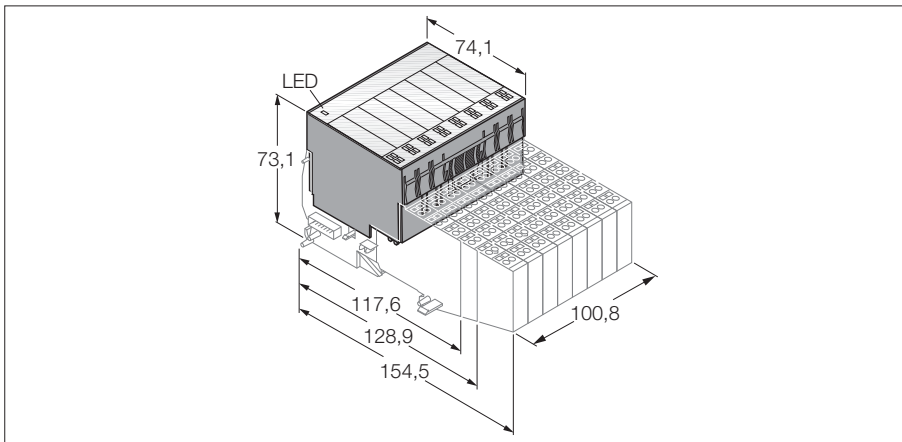

- Independent of the type of field-bus and connection technology used
- Degree of protection IP20
- LEDs for display of status and diagnostics
- Electronics galvanically isolated from the field level via opto-couplers
- 32 digital outputs, 24 VDC
- 0.5 A max.
- pnp

<b>Type</b>	BL20-32DO-24VDC-0,5A-P
Ident-No.	6827220
<b>Number of channels</b>	32
Rated voltage from the supply terminal	24 VDC
Rated current from field supply	≤ 50 mA
Rated current from module bus	≤ 120 mA
Power loss, typical	≤ 4 W
<b>Outputs</b>	
Output type	pnp
Output voltage	24 VDC
Output current per channel	0.5 A
Output delay	0.3 ms
Load type	resistive, inductive, lamp load
Load resistance, resistive	> 48 Ω
Load resistance, inductive	< 1.2 H
Lamp load	< 6 W
Switching frequency, resistive	< 100 Hz
Short-circuit protection	yes
Simultaneity factor	1
Electrical isolation	electronics for the field level
<b>Number of diagnostic bits</b>	8
<b>Operating temperature</b>	0 to +55 °C

**BL20 electronic module**  
**32 digital outputs**  
**BL20-32DO-24VDC-0,5A-P**

**Compatible base modules**

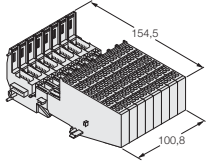
Dimensions	Type	Connection
	<p><b>6827218 BL20-B6T-SBCSBC</b> Tension spring connection, access to C rail</p> <p><b>6827219 BL20-B6S-SBCSBC</b> Screw connection, access to C rail</p>	<p>F234</p>

**Connection**

F234 - Wiring diagram

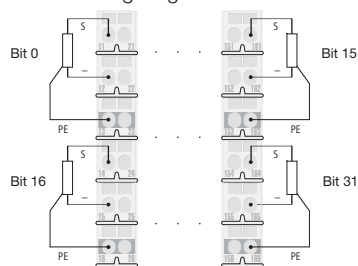

**BL20 electronic module**  
**1 analogue output**  
**BL20-1AO-I(0/4...20MA)**

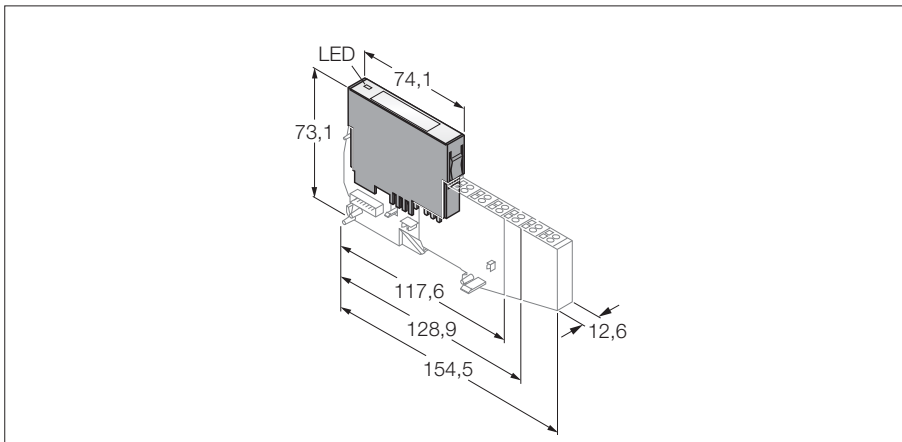

- Independent of the type of field-bus and connection technology used
- Degree of protection IP20
- LEDs for display of status and diagnostics
- Electronics galvanically isolated from the field level via opto-couplers
- 1 analogue output 0/4...20 mA

<b>Type</b>	BL20-1AO-I(0/4...20MA)
Ident-No.	6827032
<b>Number of channels</b>	1
Rated voltage from the supply terminal	24 VDC
Rated current from field supply	≤ 50 mA
Rated current from module bus	≤ 39 mA
Power loss, typical	≤ 1 W
<b>Outputs</b>	
Output type	0/4...20 mA
Load resistance, resistive	< 0.45 kΩ
Load resistance, inductive	< 1 mH
Electrical isolation	electronics for the field level
<b>Transmission frequency</b>	< 200 Hz
Basic fault limit at 23 °C	< 0.2 %
Repeatability	0.05 %
Temperature coefficient	< 300 ppm/°C of full scale
Resolution	16 Bit
Measured-value display	16 bit signed integer 12 bit full range left justified
<b>Number of parameter bytes</b>	3
<b>Operating temperature</b>	0 to +55 °C

**BL20 electronic module  
1 analogue output  
BL20-1AO-I(0/4...20MA)**

**Compatible base modules**

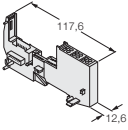
Dimensions	Type	Connection
	<p><b>6827044 BL20-S3T-SBB</b> Tension spring connection</p>	<p>F235</p>
	<p><b>6827045 BL20-S3S-SBB</b> Screw connection</p>	

**Connection**

F235 - Wiring diagram

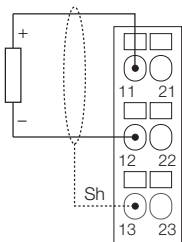

**BL20 electronic module**  
**2 analogue outputs**  
**BL20-2AO-I(4...20MA)**

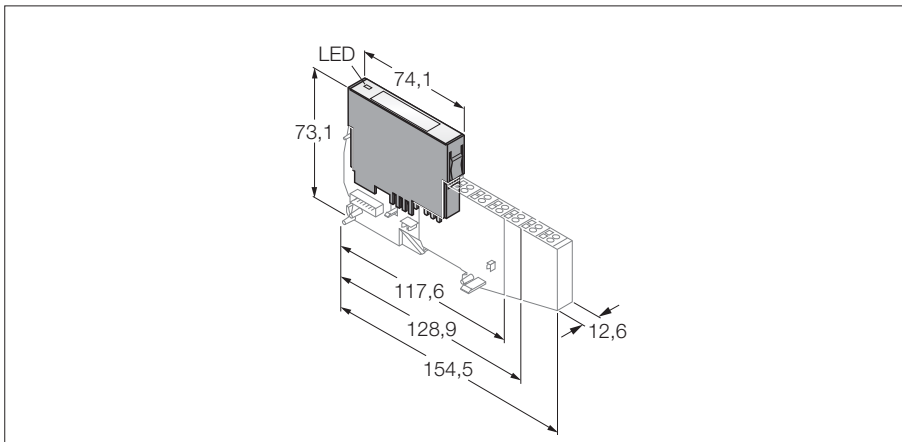

- Independent of the type of field-bus and connection technology used
- Degree of protection IP20
- LEDs for display of status and diagnostics
- Electronics galvanically isolated from the field level via opto-couplers
- 2 analogue outputs 0/4...20 mA

<b>Type</b>	BL20-2AO-I(4...20MA)
Ident-No.	6827034
<b>Number of channels</b>	2
Rated voltage from the supply terminal	24 VDC
Rated current from field supply	≤ 50 mA
Rated current from module bus	≤ 40 mA
Power loss, typical	≤ 1 W
<b>Outputs</b>	
Output type	0/4...20 mA
Load resistance, resistive	< 0.45 kΩ
Load resistance, inductive	< 1 mH
Electrical isolation	electronics for the field level
<b>Transmission frequency</b>	< 200 Hz
Basic fault limit at 23 °C	< 0.2 %
Repeatability	0.05 %
Temperature coefficient	< 150 ppm/°C of full scale
Resolution	16 Bit
Measured-value display	16 bit signed integer 12 bit full range left justified
<b>Number of parameter bytes</b>	6
<b>Operating temperature</b>	0 to +55 °C

**BL20 electronic module  
2 analogue outputs  
BL20-2AO-I(4...20MA)**

**Compatible base modules**

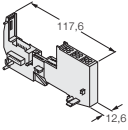
Dimensions	Type	Connection
	<b>6827044 BL20-S3T-SBB</b> Tension spring connection	F236
	<b>6827045 BL20-S3S-SBB</b> Screw connection	

**Connection**

F236 - Wiring diagram

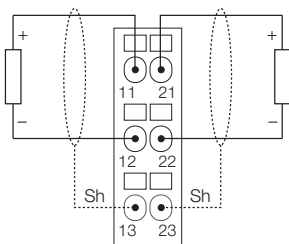

**BL20 electronic module**  
**2 analogue outputs**  
**BL20-2AO-U(-10/0...+10VDC)**

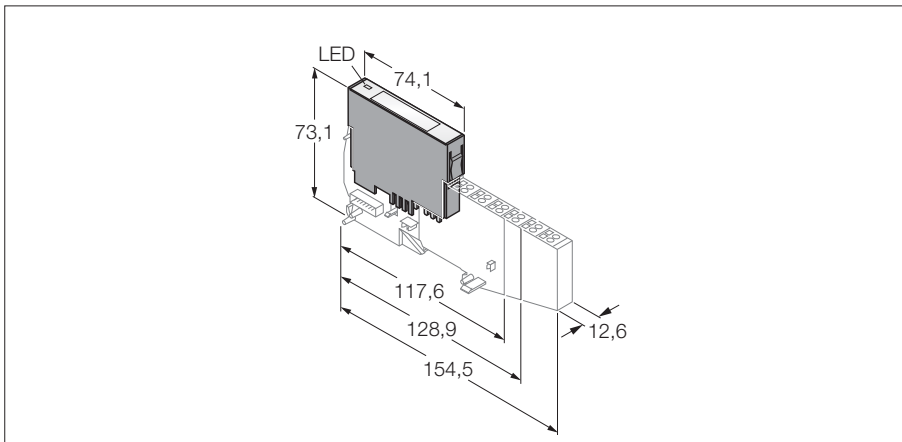

- Independent of the type of field-bus and connection technology used
- Degree of protection IP20
- LEDs for display of status and diagnostics
- Electronics galvanically isolated from the field level via opto-couplers
- 2 analogue input -10/0...+10 VDC

<b>Type</b>	BL20-2AO-U(-10/0...+10VDC)
Ident-No.	6827033
<b>Number of channels</b>	2
Rated voltage from the supply terminal	24 VDC
Rated current from field supply	≤ 50 mA
Rated current from module bus	≤ 43 mA
Power loss, typical	≤ 1 W
<b>Outputs</b>	
Output type	-10/0...+10 VDC
Load resistance, resistive	> 1 kΩ
Load resistance, capacitive	> 1 μF
Electrical isolation	electronics for the field level
<b>Transmission frequency</b>	< 100 Hz
Basic fault limit at 23 °C	< 0.2 %
Repeatability	0.05 %
Temperature coefficient	< 300 ppm/°C of full scale
Resolution	16 Bit
Measured-value display	16 bit signed integer 12 bit signed integer left-justified 12 bit full range left justified
<b>Number of parameter bytes</b>	6
<b>Operating temperature</b>	0 to +55 °C



**BL20 electronic module**  
**2 analogue outputs**  
**BL20-2AO-U(-10/0...+10VDC)**

**Compatible base modules**

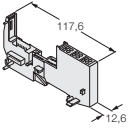
Dimensions	Type	Connection
	<p><b>6827044 BL20-S3T-SBB</b> Tension spring connection</p> <p><b>6827045 BL20-S3S-SBB</b> Screw connection</p>	<p>F236</p>

**Connection**

F236 - Wiring diagram

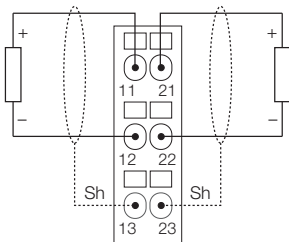

**BL20 electronic module**  
**Counter**  
**BL20-1CNT-24VDC**

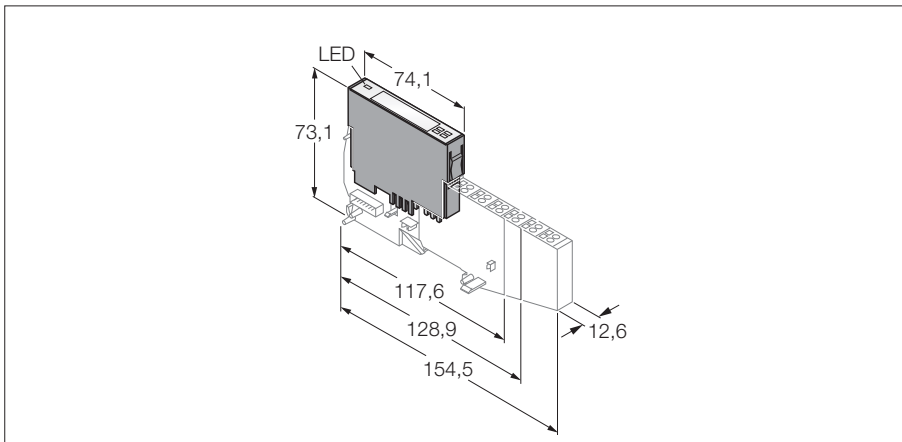

- Independent of the type of field-bus and connection technology used
- Degree of protection IP20
- LEDs for display of status and diagnostics
- Electronics galvanically isolated from the field level via opto-couplers
- Detection of standard counting signals
- 1 digital input, 24 VDC
- 1 digital output, 24 VDC, 2 A
- Counting mode: „continuous count“, „single count“ or „periodic count“
- Measuring mode: frequency, rotational speed or period duration measurement

<b>Type</b>	BL20-1CNT-24VDC
Ident-No.	6827031
<b>Number of channels</b>	1
Rated voltage from the supply terminal	24 VDC
Rated current from field supply	≤ 50 mA
Rated current from module bus	≤ 40 mA
Power loss, typical	≤ 1.3 W
<b>Electrical isolation</b>	isolation of electronics and field level via opto-couplers
<b>Input type</b>	1 x 24 VDC
Low level signal voltage	-30 to 5 VDC
High level signal voltage	11 to 30 VDC
Low level signal current	-8 mA to 1.5 mA
High level signal current	2 mA to 10 mA
Minimum pulse width (maximum count frequency)	> 25 μs (20 kHz)
Filter on	< 2.5 μs (200 kHz)
Filter off	< 0.2 ms
Input delay	
<b>Outputs</b>	
Output type	1 x 24 VDC, 2 A
Output current per channel	2
Output delay	100 ms
Load type	resistive, inductive, lamp load
Switching frequency	≤ 100 Hz
Short-circuit protection	yes
<b>Measuring ranges</b>	
Frequency measurement	0.1 Hz to 200 Hz
Speed measurement	1 r/min to 25000 r/min
Period duration measurement	5 ms to 120 s
Upper count limit	0 to 7FFF FFFF
Lower count limit	8000 0000 to FFFF FFFF
<b>Number of diagnostic bytes</b>	1
Number of parameter bytes	15
<b>Operating temperature</b>	0 to +55 °C

**BL20 electronic module**  
**Counter**  
**BL20-1CNT-24VDC**

**Compatible base modules**

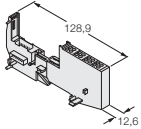
Dimensions	Type	Connection
	<p><b>6827046 BL20-S4T-SBBS</b> Tension spring connection</p> <p><b>6827047 BL20-S4S-SBBS</b> Screw connection</p>	<p>F237</p>

**Connection**

F237 - Wiring diagram

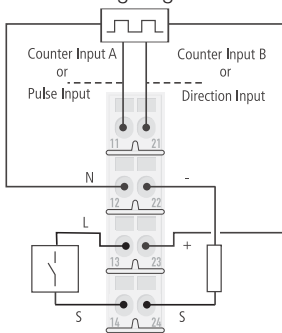

**BL20 electronic module**  
**RS232 interface**  
**BL20-1RS232**

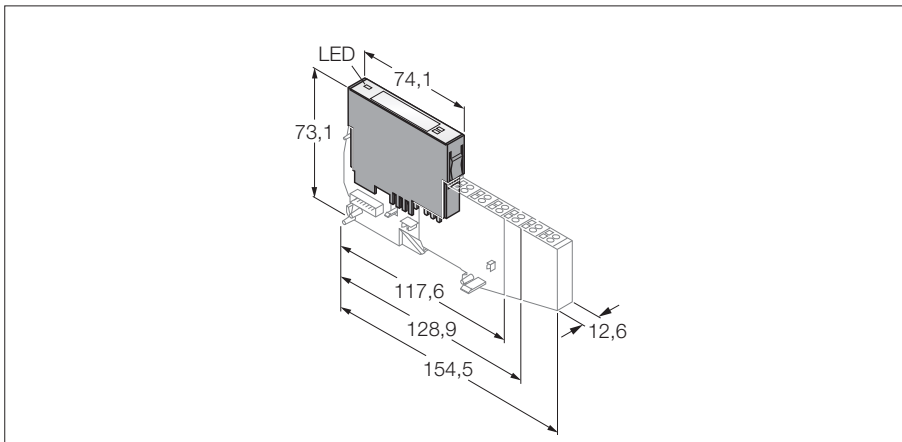

- Independent of the type of field-bus and connection technology used
- Degree of protection IP20
- LEDs for display of status and diagnostics
- Electronics galvanically isolated from the field level via opto-couplers
- Transmission of serial data via RS232 interface
- For connection of different devices, such as printers, scanners or bar code readers

<b>Type</b>	BL20-1RS232
Ident-No.	6827169
<b>Number of channels</b>	1
Rated voltage from the supply terminal	24 VDC
Rated current from field supply	≤ 25 mA
Rated current from module bus	≤ 140 mA
Power loss, typical	≤ 1 W
<b>Inputs / Outputs</b>	
Transmission level active (U RS1)	-15 to -3 VDC
Transmission level inactive (URSO)	3 to 15 VDC
Common-mode range (UGL)	-7 to 12 VDC
Transmission signals	RxD, TxD, RTS, CTS
Data buffer received	128 Byte
Send data buffer	64 Byte
Connection type	full duplex
Transmission rate	300 to 115200 bps
Parameter	transmission rate, diagnostics, data bits, stop bits, XON - character, XOFF - character, parity, flow control
Cable length	15m
Electrical isolation	isolation of electronics and field level via opto-couplers
<b>Number of diagnostic bytes</b>	1
Number of parameter bytes	4
<b>Operating temperature</b>	0 to +55 °C

**BL20 electronic module  
RS232 interface  
BL20-1RS232**

**Compatible base modules**

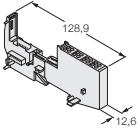
Dimensions	Type	Connection
	<p><b>6827046 BL20-S4T-SBBS</b> Tension spring connection</p> <p><b>6827047 BL20-S4S-SBBS</b> Screw connection</p>	<p>F238</p>

**Connection**

F238 - Wiring diagram

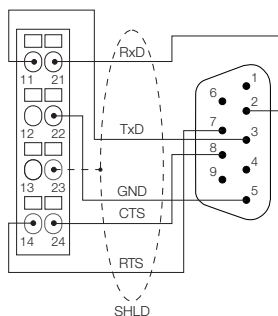

**BL20 electronic module**  
**RS485/422 interface**  
**BL20-1RS485/422**

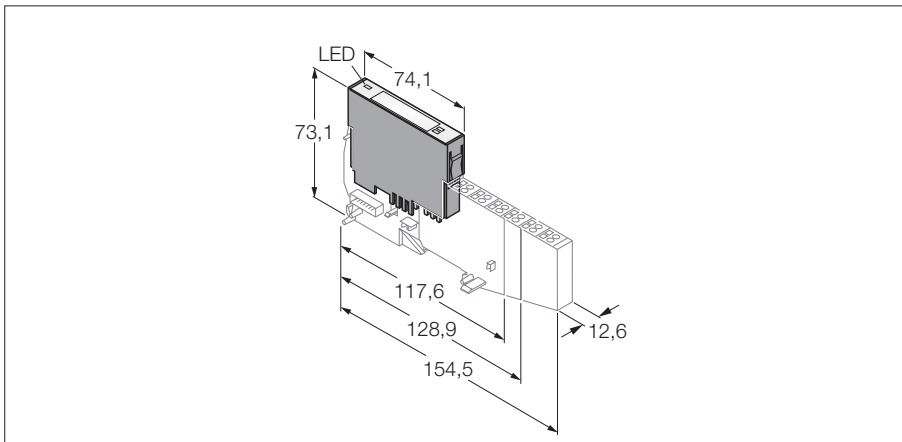

- Independent of the type of field-bus and connection technology used
- Degree of protection IP20
- LEDs for display of status and diagnostics
- Electronics galvanically isolated from the field level via opto-couplers
- Transmission of serial data via RS485/422 interface
- For connection of different devices, such as printers, scanners or bar code readers

<b>Type</b>	BL20-1RS485/422
Ident-No.	6827165
<b>Number of channels</b>	1
Rated voltage from the supply terminal	24 VDC
Rated current from field supply	≤ 25 mA
Rated current from module bus	≤ 60 mA
Power loss, typical	≤ 1 W
<b>Inputs / Outputs</b>	
Transmission signals	TxD, RxD
Data buffer received	128 Byte
Send data buffer	64 Byte
Connection type	2-wire half duplex or 4-wire full duplex
Transmission rate	300 to 115200 bps
Parameter	RS485/422, transmission rate, diagnostics, data bits, stop bits, XON - character, XOFF - character, parity, flow control
Cable length	30m
Line impedance	120 Ω
Bus termination	external
Electrical isolation	isolation of electronics and field level via opto-couplers
<b>Number of diagnostic bytes</b>	1
Number of parameter bytes	4
<b>Operating temperature</b>	0 to +55 °C

**BL20 electronic module  
RS485/422 interface  
BL20-1RS485/422**

**Compatible base modules**

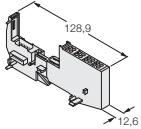
Dimensions	Type	Connection
	<b>6827046 BL20-S4T-SBBS</b> Tension spring connection	F239, F240
	<b>6827047 BL20-S4S-SBBS</b> Screw connection	

**Connection**

F239 - wiring diagram for RS422

F240 - wiring diagram for RS485

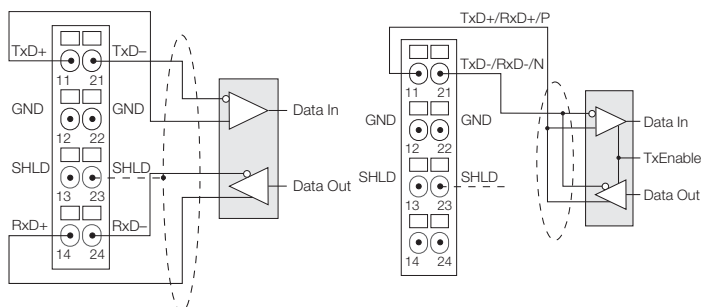

**BL20 electronic module**  
**connection of SSI sensors**  
**BL20-1SSI**

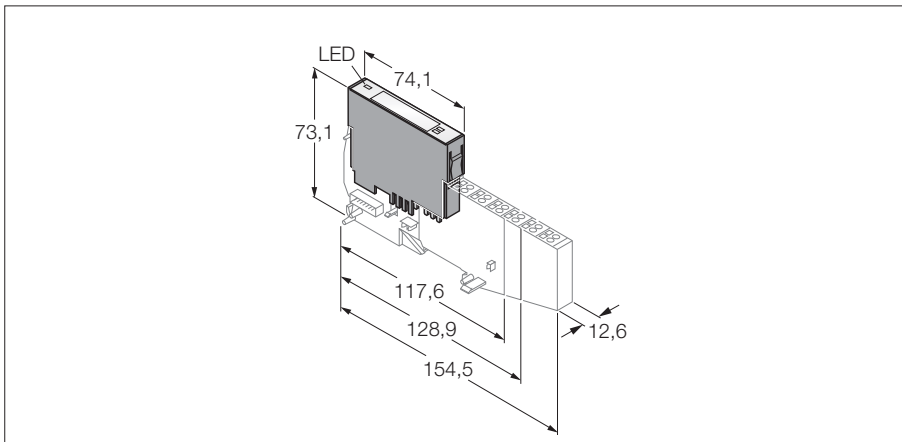

- Independent of the type of field-bus and connection technology used
- Degree of protection IP20
- LEDs for display of status and diagnostics
- Electronics galvanically isolated from the field level via opto-couplers
- Connection of SSI sensors
- Maximum bit transmission rate 1 MBit/s

<b>Type</b>	BL20-1SSI
Ident-No.	6827166
<b>Number of channels</b>	1
Rated voltage from the supply terminal	24 VDC
Rated current from field supply	≤ 25 mA
Rated current from module bus	≤ 50 mA
Power loss, typical	≤ 1 W
<b>Inputs / Outputs</b>	
Transmission signals	CL, D
Connection type	4-wire full duplex (clock output/signal input)
Transmission rate	62.5 kbps up to 1 Mbps
Parameter	transmission rate, diagnostics, data format (binary / GRAY coded), data frame bits (1-32), number of invalid bits (LSB: 0-15, MSB 0-7)
Cable length	30m
Electrical isolation	isolation of electronics and field level via opto-couplers
<b>Number of diagnostic bytes</b>	1
Number of parameter bytes	4
<b>Operating temperature</b>	0 to +55 °C



**BL20 electronic module  
connection of SSI sensors  
BL20-1SSI**

**Compatible base modules**

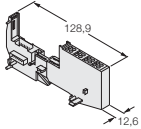
Dimensions	Type	Connection
	<b>6827046 BL20-S4T-SBBS</b> Tension spring connection	F241
	<b>6827047 BL20-S4S-SBBS</b> Screw connection	

**Connection**

F241 - Wiring diagram

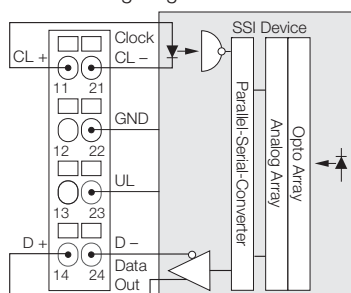

**RFID system**  
**Interface for connection of BL ident write-read heads**  
**BL20-2RFID-A**

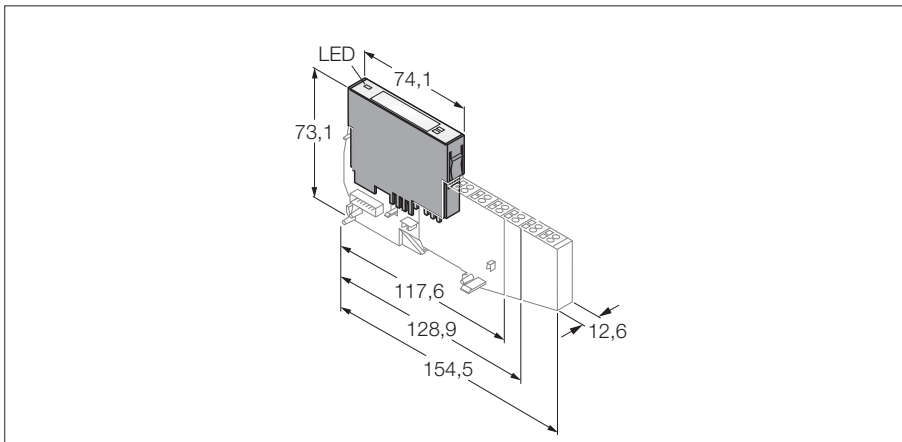

- This module is used together for example with the gateway BL20-GW-DPV1
- Degree of protection IP20
- LEDs for display of status and diagnostics
- Electronics galvanically isolated from the field level via opto-couplers
- Connection of 2 BL ident write-read heads
- transmission rate: 115.2 kbps
- Cable length: 50 m maximum

<b>Type</b>	BL20-2RFID-A
Ident-No.	6827233
<b>Number of channels</b>	2
Rated voltage from the supply terminal	24 VDC
Rated current from field supply	≤ 100 mA
Rated current from module bus	≤ 30 mA
Power loss, typical	≤ 1 W
<b>Inputs / Outputs</b>	
Transmission rate	115.2 kbps
Cable length	50m
Electrical isolation	isolation of electronics and field level via opto-couplers
<b>Simultaneity factor</b>	1
<b>Sensor supply</b>	0.25 A per channel, short-circuit proof
<b>Number of diagnostic bytes</b>	4
Number of parameter bytes	8
Number of input bytes	4
Number of output bytes	4
<b>Operating temperature</b>	0 to +55 °C

**Compatible base modules**

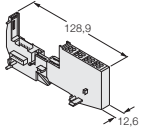
Dimensions	Type	Connection
	<b>6827046 BL20-S4T-SBBS</b> Tension spring connection	F242
	<b>6827047 BL20-S4S-SBBS</b> Screw connection	

**Connection**

F242 - Wiring diagram

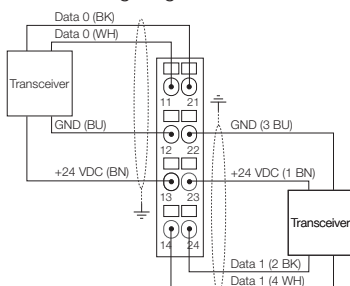

**RFID system**  
**Interface for connection of BL ident write-read heads**  
**BL20-2RFID-C**

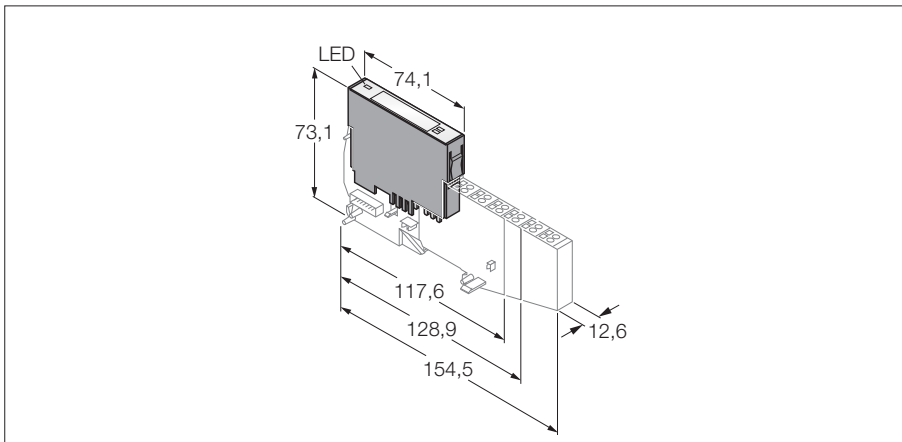

- This module is used together with the gateway BL20-GW-DPV1 (can be set to DPV0)
- Degree of protection IP20
- LEDs for display of status and diagnostics
- Electronics galvanically isolated from the field level via opto-couplers
- Connection of 2 BL ident write-read heads
- Transmission rate: 115.2 kbps
- Cable length: 50 m maximum

<b>Type</b>	BL20-2RFID-C
Ident-No.	6827239
<b>Number of channels</b>	2
Rated voltage from the supply terminal	24 VDC
Rated current from field supply	≤ 100 mA
Rated current from module bus	≤ 30 mA
Power loss, typical	≤ 1 W
<b>Inputs / Outputs</b>	
Transmission rate	115.2 kbps
Cable length	50m
Electrical isolation	isolation of electronics and field level via opto-couplers
<b>Simultaneity factor</b>	1
<b>Sensor supply</b>	0.25 A per channel, short-circuit proof
<b>Number of diagnostic bytes</b>	4
Number of parameter bytes	8
Number of input bytes	32
Number of output bytes	32
<b>Operating temperature</b>	0 to +55 °C

**Compatible base modules**

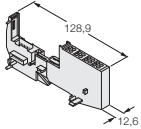
Dimensions	Type	Connection
	<b>6827046 BL20-S4T-SBBS</b> Tension spring connection	F242
	<b>6827047 BL20-S4S-SBBS</b> Screw connection	

**Connection**

F242 - Wiring diagram

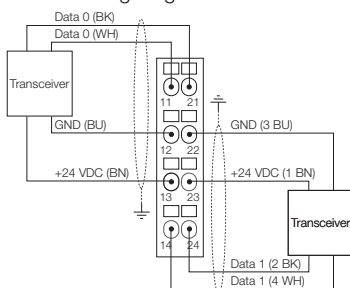

**BL20 Economy Module**  
**SWIRE communication module**  
**BL20-E-1SWIRE**

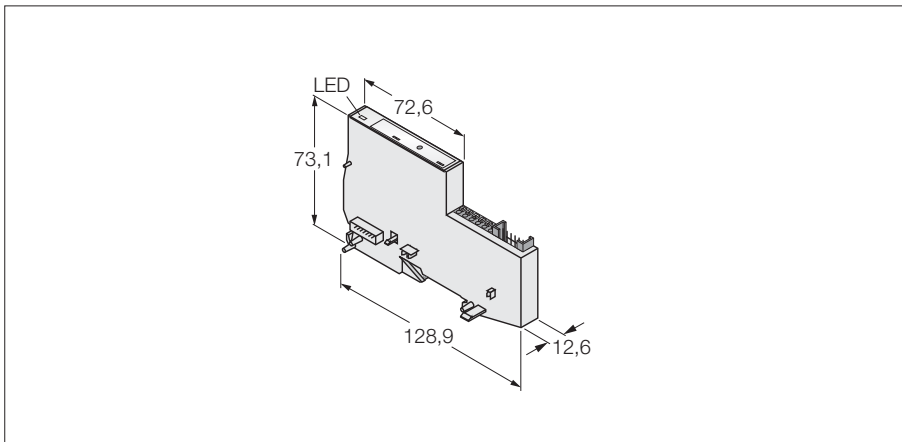

- Independent of the type of field-bus used
- Electronics and connection technology in a single housing
- Tension spring connection technology
- Degree of protection IP20
- LEDs for display of status and diagnostics
- Electronics galvanically isolated from the field level via opto-couplers
- Supports the connection of a SWIRE branch.
- Maximum 16 nodes per SWIRE branch
- Maximum 3 SWIRE modules per BL20 station

<b>Type</b>	BL20-E-1SWIRE
Ident-No.	6827251
<b>Number of channels</b>	1 SWIRE branch
Admissible range	18...30 VDC
Voltage supply for contactor	24 VDC
Voltage supply for contactor	3 A
Rated current from module bus	≤ 60 mA
<b>Electrical isolation</b>	isolation of electronics and field level via opto-couplers
<b>Number of diagnostic bytes</b>	8
Number of parameter bytes	24
<b>Operating temperature</b>	0 to +55 °C



# BL20 motor starter – Save switching and protection of motors

## Direct and reversing starters up to 15 kW

The motor starters consequently build upon the advantages of the BL20 system:

- Modular:
- Flexible
- Simple mounting and operation
- Cost-efficient

BL20 direct and reversing motor starters fulfil the requirements of the IEC/EN 60947-4-1 norm for industrial switching devices.

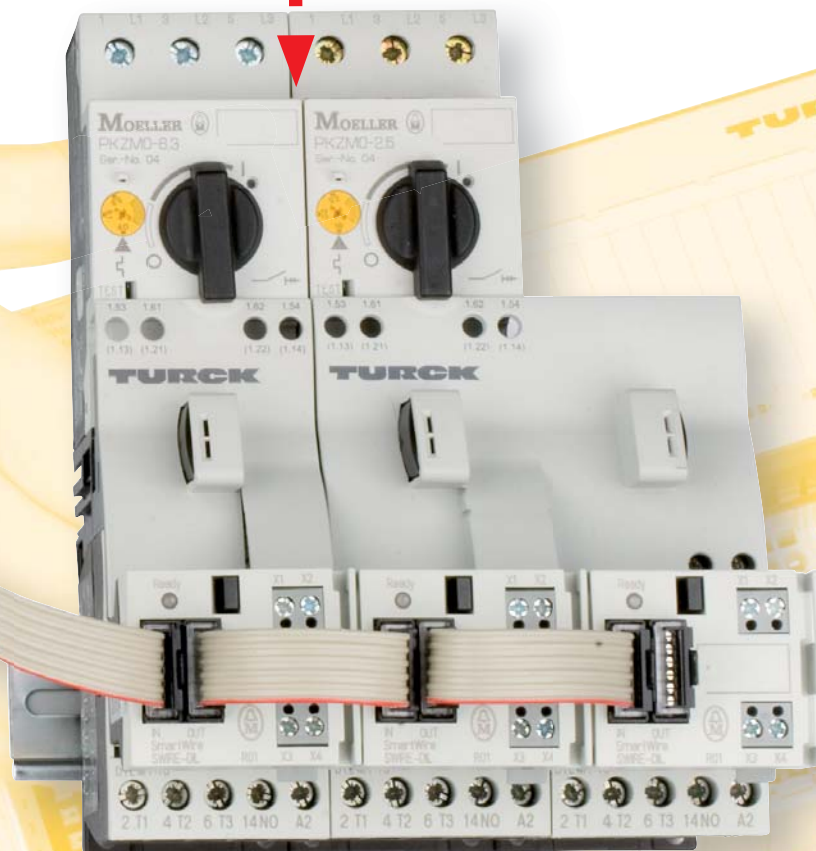

## Modular mounting

A BL20 motor starter is composed of standard components. Easy and error-free mounting of direct or reversing starters with a power range between 0.06 kW and 15 kW is thus possible. This applies to the single components of which a motor starter is built, as well as to the connection between motor starters and the gateway.

Should it become necessary to adapt the motor starter to altered conditions, the relevant components can be easily exchanged.

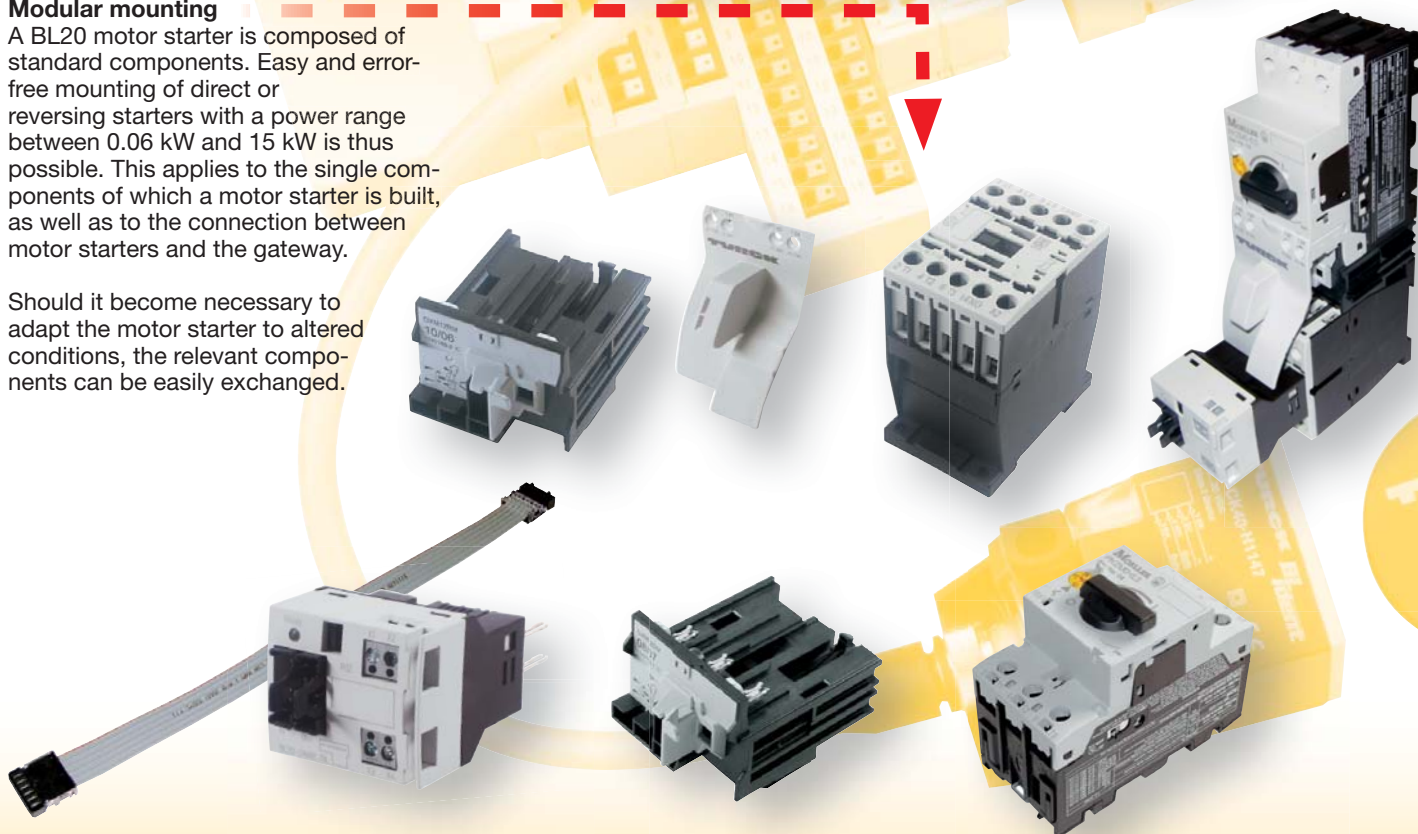



**Compact system solution**

The SWIRE connection module allows a maximum of 4 m between the module and the last motor starter. This allows an exceptionally flexible layout of the motor starters in the control cabinet and thus compact solutions.



← SWIRE connection



← maximum distance 4 m

**Communication**

Due to digital communications between the motor starters and the BL20, various diagnostics are available to the host system. This is realised without the need for extra I/Os.

This means:

- Reduction of commissioning times
- Quick trouble shooting
- Lower costs

**Configuration**

The integration of motor starters in the BL20 system is very easy: All connected motor starters are configured in the BL20 system by a simple tap on a push-button.

**Maximum system expansion**





Up to 16 motor starters per SWIRE module, up to 3 SWIRE branches per BL20-system = up to 48 motor starters per fieldbus interface!



# BL20 motor starter – Selection guide direct starter

	=		+		+		
<b>Rated operating performance</b>	<b>Motor protection switch</b>		<b>Auxiliary switch for motor protection switch</b>		<b>SWIRE communication module</b>		
AC-3 , 380 V...415 V							
<b>P, kW / hp</b>			<b>5 pcs / package</b>		<b>5 pcs /package</b>		
0,06 / 0,08	PKZM0-0,25 6827283		NHI-E-10L-PKZ0 (5pcs) 6827254		BL20-SWIRE-DIL(5pcs) 6827291		
0,09 / 0,12	PKZM0-0,4 6827282						
0,12 / 0,16	PKZM0-0,63 6827280						
0,18 / 0,24	PKZM0-0,63 6827280						
0,25 / 0,33	PKZM0-1 6827279						
0,37 / 0,5	PKZM0-1,6 6827255						
0,55 / 0,74	PKZM0-1,6 6827255						
0,75 / 1	PKZM0-2,5 6827256						
1,1 / 1,5	PKZM0-4 6827257						
1,5 / 2	PKZM0-4 6827257						
2,2 / 2,95	PKZM0-6,3 6827258						
3 / 4	PKZM0-10 6827259						
4 / 5,4	PKZM0-10 6827259						
5,5 / 7,38	PKZM0-12 6827260						
7,5 / 10	PKZM0-16 6827284						
7,5 / 10	PKZM0-16 6827284						
11 / 15	PKZM0-25 6827285						
15 / 20	PKZM0-32 6827261						

\* These power contactors require a different wiring set as mentioned here

Type "1" coordination		Type "2" coordination	
In type "1" coordination, the contactor or soft starter must not endanger persons or the installation in the event of a short-circuit and does not have to be capable of continued use without repairs or parts replacements.		In type "2" coordination, the contactor or soft starter must not endanger persons or the installation in the event of a short-circuit and must be capable of continued use without repairs or parts replacements.	
+		+	
			
<b>Power contactor</b>		<b>Power contactor</b>	
+		+	
			
<b>Wiring set</b>		<b>Wiring set</b>	
Aux. contact		Aux. contact	
1 x N.C.	1 x N. O.	1 x N.C.	1 x N.O.
<p>DILM7-01(24VDC) 6827541</p> <p>DILM9-01(24VDC) 6827543</p> <p>DILM12-01(24VDC) 6827542</p> <p>DILM15-01(24VDC) 6827538</p> <p>DILM17-01(RDC24)* 6827298</p> <p>DILM25-01(RDC24)* 6827539</p> <p>DILM32-01(RDC24)* 6827540</p>	<p>DILM7-10(24VDC) 6827267</p> <p>DILM9-10(24VDC) 6827268</p> <p>DILM12-10(24VDC) 6827278</p> <p>DILM15-10(24VDC) 6827287</p> <p>DILM17-10(RDC24)* 6827297</p> <p>DILM25-10(RDC24)* 6827281</p> <p>DILM32-10(RDC24)* 6827270</p>	<p>BL20-PKZM0-XDM12 6827262</p> <p>BL20-PKZM0-XDM32 6827263</p>	<p>DILM7-01(24VDC) 6827541</p> <p>DILM7-10(24VDC) 6827267</p> <p>DILM17-01(RDC24)* 6827298</p> <p>DILM17-10(RDC24)* 6827297</p> <p>DILM25-01(RDC24)* 6827539</p> <p>DILM32-01(RDC24)* 6827540</p>

# BL20 motor starter – Selection guide reversing starter

	=		+		+	<b>2 ×</b> 	
<b>Rated operating performance</b>	<b>Motor protection switch</b>	<b>Auxiliary switch for motor protection switch</b>	<b>SWIRE communication module</b>				
AC-3 , 380 V...415 V							
<b>P, kW / hp</b>		5 pcs / package	5 pcs / package				
0,06 / 0,08	PKZM0-0,25 6827283						
0,09 / 0,12	PKZM0-0,4 6827282						
0,12 / 0,16	PKZM0-0,63 6827280						
0,18 / 0,24	PKZM0-0,63 6827280						
0,25 / 0,33	PKZM0-1 6827279						
0,37 / 0,5	PKZM0-1,6 6827254						
0,55 / 0,74	PKZM0-1,6 6827254						
0,75 / 1	PKZM0-2,5 6827256						
1,1 / 1,5	PKZM0-4 6827257						
1,5 / 2	PKZM0-4 6827257						
2,2 / 2,95	PKZM0-6,3 6827258	NHI-E-10L-PKZ0 (5pcs) 6827254	BL20-SWIRE-DIL(5pcs) 6827291				
3 / 4	PKZM0-10 6827259						
4 / 5,4	PKZM0-10 6827259						
5,5 / 7,38	PKZM0-12 6827260						
7,5 / 10	PKZM0-16 6827284						
7,5 / 10	PKZM0-16 6827284						
11 / 15	PKZM0-25 6827285						
15 / 20	PKZM0-32 6827261						

\* These power contactors require a different wiring set as mentioned here

Type "1" coordination			Type "2" coordination		
In type "1" coordination, the contactor or soft starter must not endanger persons or the installation in the event of a short-circuit and does not have to be capable of continued use without repairs or parts replacements.			In type "2" coordination, the contactor or soft starter must not endanger persons or the installation in the event of a short-circuit and must be capable of continued use without repairs or parts replacements.		
<b>Power contactor</b>		<b>Wiring set</b>	<b>Power contactor</b>		<b>Mech. interlock</b>
Aux. contact			Aux. contact		
1 x N.C.	1 x N. O.		1 x N.C.	1 x N. O.	
DILM7-01(24VDC) 6827541	DILM7-10(24VDC) 6827267	BL20-PKZM0-XRM12 6827264	DILM12-01(24VDC) 6827542	DILM12-10(24VDC) 6827278	DILM12-01(24VDC) 6827543
DILM9-01(24VDC) 6827543	DILM9-10(24VDC) 6827268		DILM17-01(RDC24)* 6827298	DILM17-10(RDC24)* 6827297	DILM17-01(RDC24)* 6827298
DILM25-01(RDC24)* 6827539	DILM25-10(RDC24)* 6827281	BL20-PKZM0-XRM32 6827286	DILM25-01(RDC24)* 6827539	DILM25-10(RDC24)* 6827281	DILM25-01(RDC24)* 6827539
DILM32-01(RDC24)* 6827540	DILM32-10(RDC24)* 6827270		DILM32-01(RDC24)* 6827540	DILM32-10(RDC24)* 6827270	DILM32-01(RDC24)* 6827540

# BL20 motor starter – Technical specification motor protection switch

Type	Ident-no.	Max. rated operating performance					Rated continuous current	Setting range overload release	Short circuit release
		AC3							
		220 V	380 V	440 V	500 V	660 V			
		230 V	400V			690 V			
		240 V	415 V						
			P [kW]					$I_U$ [A]	$I_r$ [A]
PKZM0-0,25	6827283		0,06	0,06	0,06	0,12	0,25	0,16...0,25	3,5
PKZM0-0,4	6827282	0,06	0,09	0,12	0,12	0,18	0,4	0,25...0,4	5,6
PKZM0-0,63	6827280	0,09	0,12	0,18	0,25	0,25	0,63	0,4...0,63	6,8
PKZM0-1	6827279	0,12	0,25	0,25	0,37	0,55	1	0,63...1	14
PKZM0-1,6	6827254	0,25	0,55	0,55	0,75	1,1	1,6	1...1,6	22
PKZM0-2,5	6827256	0,37	0,75	1,1	1,1	1,5	2,5	1,6...2,5	35
PKZM0-4	6827257	0,75	1,5	1,5	2,2	3	4	2,5...4	56
PKZM0-6,3	6827258	1,1	2,2	3	3	4	6,3	4...6,3	88
PKZM0-10	6827259	2,2	4	4	4	7,5	10	6,3...10	140
PKZM0-12	6827260	3	5,5	5,5	5,5	11	12	8...12	168
PKZM0-16	6827284	4	7,5	9	9	12,5	16	10...16	224
PKZM0-25	6827285	5,5	12,5	12,5	15	22	25	20...25	350
PKZM0-32	6827261	7,5	15	15	22	30	32	25...32	448

## Tripping characteristic for motor protection switch PKZM0-...

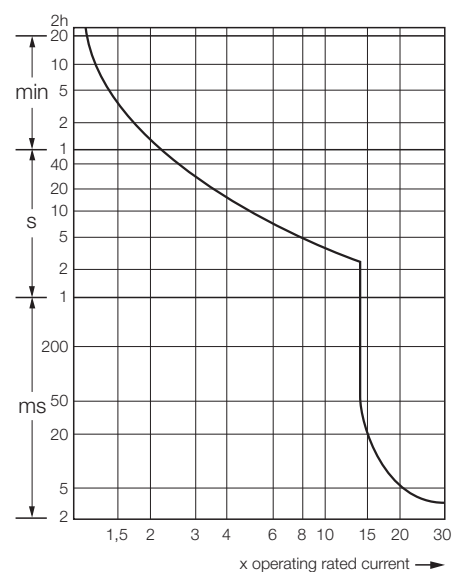

# BL20 motor starter – Technical specification power contactor

Type	Ident-no.	Rated operating current	Max. rated operating performance three-phase AC motor 50...60 Hz						$I_{th} = I_e$ , AC-1 at 60°C, open	Contact-complement	
			AC-3			AC-4					
			380 V	220 V	380 V	660 V	220 V	380 V	660 V		
			400 V	230 V	400 V	690 V	230 V	400 V	690 V		
			$I_e$ [A]	P [kW]			P [kW]			$I_{th} = I_e$ [A]	N.O./N.C.
DILM7-01(24VDC)	6827541	7	2,2	3	3,5	1	2,2	2,9	20	N.C.	
DILM7-10(24VDC)	6827267	7	2,2	3	3,5	1	2,2	2,9	20	N.O.	
DILM9-01(24VDC)	6827543	9	2,5	4	4,5	1,5	2,5	3,6	20	N.C.	
DILM9-10(24VDC)	6827268	9	2,5	4	4,5	1,5	2,5	3,6	20	N.O.	
DILM12-01(24VDC)	6827542	12	3,5	5,5	6,5	2	3	4,4	20	N.C.	
DILM12-10(24VDC)	6827278	12	3,5	5,5	6,5	2	3	4,4	20	N.O.	
DILM15-01(24VDC)	6827538	15,5	4	7,5	7	2	3	4,4	20	N.C.	
DILM15-10(24VDC)	6827287	15,5	4	7,5	7	2	3	4,4	20	N.O.	
DILM17-01(RDC24)	6827298	18	5	7,5	11	2,5	4,5	6,5	35	N.C.	
DILM17-10(RDC24)	6827297	18	5	7,5	11	2,5	4,5	6,5	35	N.O.	
DILM25-01(RDC24)	6827539	25	7,5	11	14	3,5	6	8,5	40	N.C.	
DILM25-10(RDC24)	6827281	25	7,5	11	14	3,5	6	8,5	40	N.O.	
DILM32-01(RDC24)	6827540	32	10	15	17	4	7	10	40	N.C.	
DILM32-01(RDC24)	6827270	32	10	15	17	4	7	10	40	N.O.	

## Electrical interlock wiring for reversing starters

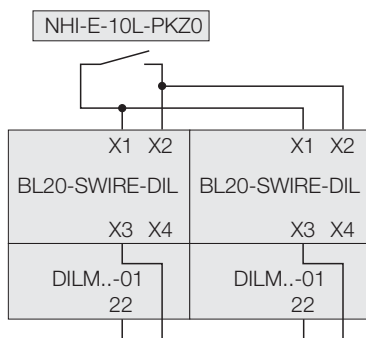

Power contactors with a N.C. output are obligatory for the electrical interlock of reversing starters. The wiring is implemented by the user as shown on the left. All other necessary connections are implemented with pluggable bridges which are included in the wiring sets.

# BL20 motor starter – Accessories

Figure	Description	Type	Ident-no.
	Three-phase current rail, insulated, $U_e = 690\text{ V}$ , $I_U = 63\text{ A}$ , extension enabled by rotated mounting, length 90 mm	<b>B3.0/2-PKZ0</b>	6827099
	Three-phase current rail, insulated, $U_e = 690\text{ V}$ , $I_U = 63\text{ A}$ , extension enabled by rotated mounting, length 180 mm	<b>B3.0/4-PKZ1</b>	6827098
	Input terminal for three-phase current rail, insulated, $U_e = 690\text{ V}$ , $I_U = 63\text{ A}$ ,	<b>BK25/3-PKZ0</b>	6827134
	No-load connection cover for non-assigned connections at three-phase current rails 20 pcs/ package	<b>H-B3-PKZ0(20pcs)</b>	6827544
	SWIRE power module. For power supply of SWIRE branches. Is applied when groups of motor starters have to be disconnected. Max. 4 Power modules per SWIRE branch.	<b>BL20-SWIRE-PF</b>	6827288
	Terminating connector for SWIRE-branches, no electrical function 25 pcs / package	<b>BL20-SWIRE-CAB-000 (25pcs)</b>	6827292
	SWIRE connection cable, length 85 mm 25 pcs / package	<b>BL20-SWIRE-CAB-008 (25pcs)</b>	6827274
	SWIRE connection cable, length 110 mm 25 pcs / package	<b>BL20-SWIRE-CAB-011 (25pcs)</b>	6827275
	SWIRE connection cable, length 150 mm 5 pcs / package	<b>BL20-SWIRE-CAB-015 (5pcs)</b>	6827293
	SWIRE connection cable, length 250 mm 5 pcs / package	<b>BL20-SWIRE-CAB-025 (5pcs)</b>	6827276
	SWIRE connection cable, length 500 mm	<b>BL20-SWIRE-CAB-050</b>	6827296
	SWIRE connection cable, length 1000 mm	<b>BL20-SWIRE-CAB-100</b>	6827294
	SWIRE connection cable, length 2000 mm	<b>BL20-SWIRE-CAB-200</b>	6827295
	Mechanical interlock for reversing starters with power contactors DILM7-DILM15	<b>DILM12-XMV</b>	6827269
	Mechanical interlock for reversing starters with power contactors DILM17-DILM32	<b>DILM32-XMV</b>	6827545

## User manuals

The user manual for BL20 systems is only available as PDF file and can be downloaded on [www.turck.com](http://www.turck.com)





**DIGITAL**  
**ANALOGUE**  
**TECHNOLOGY**  
**RFID**

  
**EtherNet/IP™**

**PROFI**<sup>®</sup>  
INDUSTRIAL ETHERNET  
**NET**

**CANopen**

**Modbus TCP**

**PROFI**  
PROCESS FIELD BUS  
**BUS**

  
**DeviceNet™**

	<b>Page</b>
<b>The JIT-5D-Programme</b>	
Type code	A0 – 5
PROFIBUS-DP-cables and power cables	A0 – 6
DeviceNet™/CAN-cables	A0 – 7
PROFIBUS-PA-cables	A0 – 8
FOUNDATION fieldbus™-cables	A0 – 9
<b>Bus cables</b>	
Bus cables and power cables	A1 – 2
PROFIBUS-DP – bus cables	A1 – 6
DeviceNet™ – bus cables	A1 – 14
Ethernet – bus cables	A1 – 28
<b>Power cables</b>	
PROFIBUS-DP – power cable, cable type 52	A2 – 2
DeviceNet™ – power cable, cable type 43	A2 – 6
<i>piconet</i> ® – power cable, cable type IPS	A2 – 10
<b>Accessories – bus</b>	
PROFIBUS-DP – T-pieces, Y-pieces, terminating resistors, Prefabricated connectors, flanges, feed-through receptacles	A3 – 2
DeviceNet™/CANopen – T-pieces, Y-pieces, terminating resistors, Passive junctions, prefabricated connectors, flanges, feed-through recept.	A3 – 8
Ethernet – Switches, M12/RJ45-Umsetzer	A3 – 17
<b>Accessories – power supply</b>	
Kabeltyp 52 – T-pieces, prefabricated connectors, feed-through recept.	A4 – 2
Kabeltyp 43 – T-pieces, prefabricated connectors, feed-through recept.	A4 – 5
<b>Accessories – connectors for sensors/actuators</b>	
Connectors in connection technology M8, M12 und M23	A5 – 2

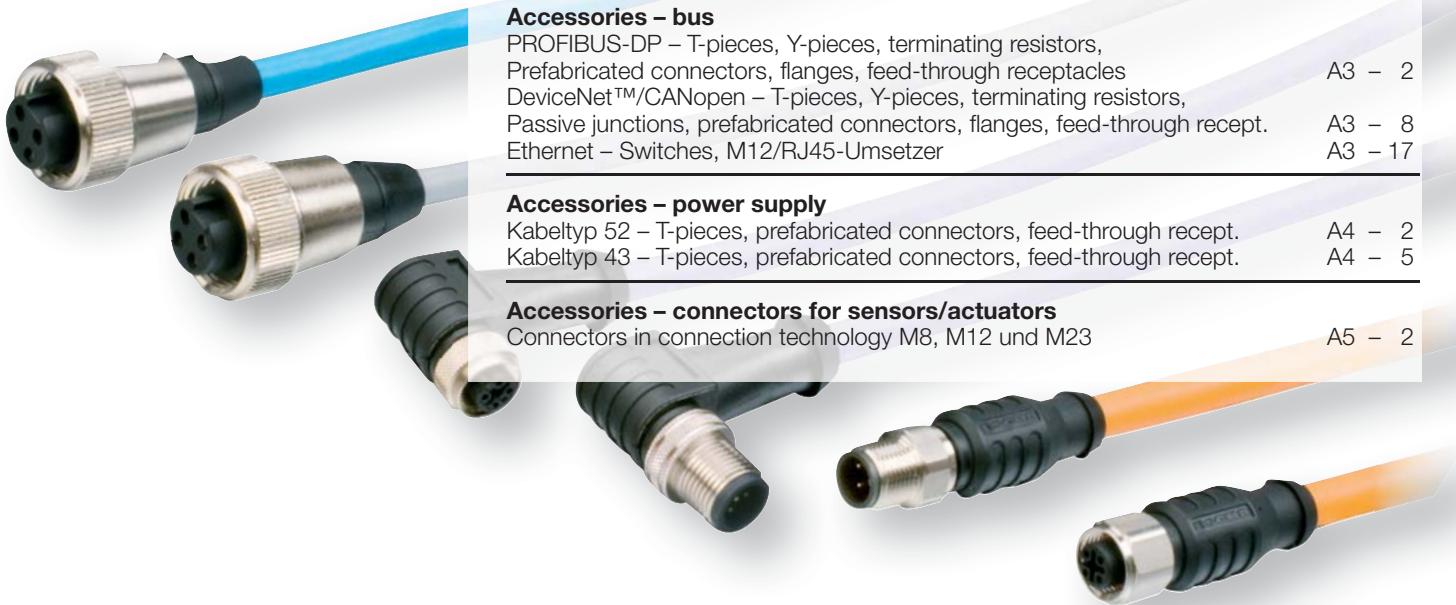

# JIT – Just in Time

Ideally the length of the cord set is adjusted according to the requirements of the plant. For this reason TURCK now offers a Just-In-Time-delivery service (JIT) for premoulded cables.

## The new JIT-5D-Programme for perfect connections:

- Just-In-Time delivery within 5 days only\*
- Free choice of cable length
- Premoulded fieldbus and power cables
- High flexibility with respect to planning and mounting of your application
- High cost savings



\* valid for deliveries within the European Union (EU)

# JIT – product range

## Type code

**TURCK**

Industrial  
Automation

<b>RKCV – RSCV – FBY49x – *M / 5D</b>	
<p><b>Geometry</b>  <b>R:</b> straight  <b>W:</b> angled</p>	<p><b>Just-in-time-Programme (5 days)</b></p>
<p><b>Connection mode</b>  <b>S:</b> male  <b>K:</b> female</p>	<p><b>Cable length</b>            0,3 and 0,5 m            1 ... 5 m (available in 0.5 m steps)            5 ... 50 m (available in 1.0 m steps)</p>
<p><b>Mechanical connection</b>  <b>C:</b> M12  <b>without:</b> 7/8"  <b>S:</b> M12 shielded</p>	<p><b>Fieldbus system</b>  <b>451:</b> PROFIBUS-DP, suited for trailing applications  <b>452:</b> PROFIBUS-DP  <b>572:</b> DeviceNet™  <b>52:</b> power cable 7/8", 5-pole  <b>43:</b> power cable 7/8", 4-pole  <b>FBY48x:</b> PROFIBUS-PA  <b>FBY49x:</b> FOUNDATION™ fieldbus            x = colour: BU = blue, BK = black, OG = orange, YE= yellow</p>
<p><b>Coupling nut/Coding</b>  <b>M/without:</b> coupling nut: brass, nickel-plated  <b>V:</b> coupling nut: stainless steel  <b>W:</b> coupling nut: brass, nickel-plated, reverse-keyed connectors</p>	<p><b>for premoulded cables on both ends</b></p>

**A0**

# PROFIBUS-DP – cables, type 451/452 power cables, type 43/52



M12 x 1	Type designation x = cable type 451 or 452, *M = variable length in m (see type code)				
	<b>one-sided premoduled</b>	<b>RSSW</b> 	<b>WSSW</b> 	<b>RKSW</b> 	<b>WKSW</b> 
<b>RSSW</b> 	RSSW-45x-*M/5D	RSSW-RSSW-45x-*M/5D	—	RSSW-RKSW-45x-*M/5D	—
<b>WSSW</b> 	WSSW-45x-*M/5D	—	WSSW-WSSW-45x-*M/5D	—	WSSW-WKSW-45x-*M/5D
<b>RKSW</b> 	RKSW-45x-*M/5D	—	—	RKSW-RKSW-45x-*M/5D	—
<b>WKSW</b> 	WKSW-45x-*M/5D	—	—	—	WKSW-WKSW-45x-*M/5D

### Pin configuration:

Male   
 Female

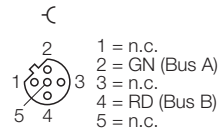
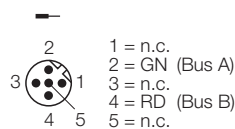

7/8"	Type designation x = cable type 43 or 52, *M = variable length in m (see type code)				
	<b>one-sided premoduled</b>	<b>RSM</b> 	<b>WSM</b> 	<b>RKM</b> 	<b>WKM</b> 
<b>RSM</b> 	RSM-x-*M/5D	RSM-RSM-x-*M/5D	—	RSM-RKM-x-*M/5D	—
<b>WSM</b> 	WSM-x-*M/5D	—	WSM-WSM-x-*M/5D	—	WSM-WKM-x-*M/5D
<b>RKM</b> 	RKM-x-*M/5D	—	—	RKM-RKM-x-*M/5D	—
<b>WKM</b> 	WKM-x-*M/5D	—	—	—	WKM-WKM-x-*M/5D

### Cable type 43

### Pin configuration:

Male   
 Female

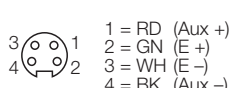
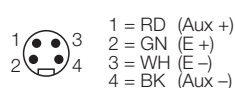

### Cable type 52

### Pin configuration:

Male   
 Female

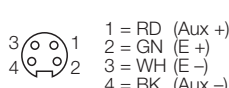
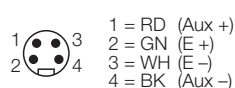

### Connectors:

Coupling nut: Brass  
nickel-plated  
Contacts: Gold-plated  
Grip: PA  
Protection degree: IP67

### Cable layout

	451	452	43	52
Outer Jacket:	TPU, purple	PVC, purple	PUR, grey	PUR, grey
Core isolation:	PE	PE	PP	PP
Colour code:	GN, RD	GN, RD	BK, GN, RD, WH	BK, BU, GNYE, BN, WH
	Aluminium foil, tin-plated copper braid	Aluminium foil, tin-plated copper braid	—	—
Diameter:	approx. 8.5 mm	approx. 8.1 mm	approx. 7.5 mm	approx. 8.1 mm
Core diameter:	AWG22/7	AWG22/1	4 x 1.5 mm <sup>2</sup>	5 x 1.5 mm <sup>2</sup>
Trailing application:	5 mio. cycles	—	yes	yes
U <sub>L</sub> approval:	—	yes	—	—

# DeviceNet™/CAN – cables, type 572



**TURCK**

Industrial  
Automation

M12 x 1	Type designation cable type 572, *M = variable length in m (see type code)				
	<b>RSC</b>	<b>WSC</b>	<b>RKC</b>	<b>WKC</b>	
<b>RSC</b>	RSC-572-*M/5D	RSC-RSC-572-*M/5D	—	RSC-RKC-572-*M/5D	—
<b>WSC</b>	WSC-572-*M/5D	—	WSC-WSC-572-*M/5D	—	WSC-WKC-572-*M/5D
<b>RKC</b>	RKC-572-*M/5D	—	—	RKC-RKC-572-*M/5D	—
<b>WKC</b>	WKC-572-*M/5D	—	—	—	WKC-WKC-572-*M/5D

**Pin configuration:**

Male   
Female

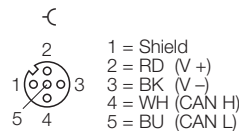
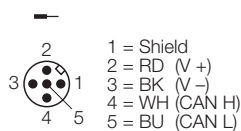

7/8"	Type designation cable type 572, *M = variable length in m (see type code)				
	<b>RSM</b>	<b>WSM</b>	<b>RKM</b>	<b>WKM</b>	
<b>RSM</b>	RSM-572-*M/5D	RSM-RSM-572-*M/5D	—	RSM-RKM-572-*M/5D	—
<b>WSM</b>	WSM-572-*M/5D	—	WSM-WSM-572-*M/5D	—	WSM-WKM-572-*M/5D
<b>RKM</b>	RKM-572-*M/5D	—	—	RKM-RKM-572-*M/5D	—
<b>WKM</b>	WKM-572-*M/5D	—	—	—	WKM-WKM-572-*M/5D

**Pin configuration:**

Male   
Female

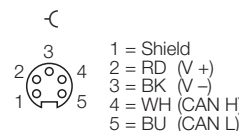
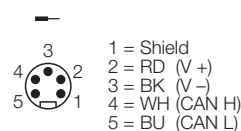

**Connectors:**

Coupling nut: Brass,  
nickel-plated  
Contacts: Gold-plated  
Grip: PA  
Protection degree: IP67

**Cable layout**

Outer jacket: PVC, grey  
Core isolation: PE  
Colour code: RD, BK, WH, BU  
Shield: Aluminium foil  
Diameter: approx. 7.2 mm  
Core diameter: AWG22/19  
Trailing application: —  
U<sub>L</sub> approval: yes

**572**

# PROFIBUS-PA – cables

## Cable FBY48...



M12 x 1		Type designation cable type FBY48x, x = colour (BU, BK, OG, YE), *M = variable length in m (see type code)			
	einseitig vorkonfektioniert	<b>RSCV</b> 	<b>WSCV</b> 	<b>RKCV</b> 	<b>WKCV</b> 
<b>RSCV</b>	RSCV-FBY48x-*M/5D	RSCV-RSCV-FBY48x-*M/5D	—	RSCV-RKCV-FBY48x-*M/5D	—
<b>WSCV</b>	WSCV-FBY48x-*M/5D	—	WSCV-WSCV-FBY48x-*M/5D	—	WSCV-WKCV-FBY48x-*M/5D
<b>RKCV</b>	RKCV-FBY48x-*M/5D	—	—	RKCV-RKCV-FBY48x-*M/5D	—
<b>WKCV</b>	WKCV-FBY48x-*M/5D	—	—	—	WKCV-WKCV-FBY48x-*M/5D

### Pin configuration:

Male   
 Female

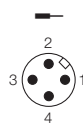

1 = + (BN)  
2 = n.c.  
3 = - (BU)  
4 = S (Shield)

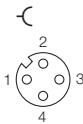

1 = + (BN)  
2 = n.c.  
3 = - (BU)  
4 = S (Shield)

7/8"		Type designation cable type FBY48x, x = colour (BU, BK, OG, YE), *M = variable length in m (see type code)			
	einseitig vorkonfektioniert	<b>RSV</b> 	<b>WSV</b> 	<b>RKV</b> 	<b>WKV</b> 
<b>RSV</b>	RSV-FBY48x-*M/5D	RSV-RSV-FBY48x-*M/5D	—	RSV-RKV-FBY48x-*M/5D	—
<b>WSV</b>	WSV-FBY48x-*M/5D	—	WSV-WSV-FBY48x-*M/5D	—	WSV-WKV-FBY48x-*M/5D
<b>RKV</b>	RKV-FBY48x-*M/5D	—	—	RKV-RKV-FBY48x-*M/5D	—
<b>WKV</b>	WKV-FBY48x-*M/5D	—	—	—	WKV-WKV-FBY48x-*M/5D

### Pin configuration:

Male   
 Female



1 = + (BN)  
2 = n.c.  
3 = - (BU)  
4 = S (Shield)

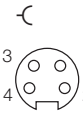

1 = + (BN)  
2 = n.c.  
3 = - (BU)  
4 = S (Shield)

### Connectors:

Coupling nut: Stainless steel  
Contacts: Gold-plated  
Grip: PA  
Protection degree: IP67

### Cable layout

Outer jacket: Polyvinyl chloride (PVC)  
Core isolation: PE-foam with PR-jacket  
Colour code: BN, BU  
Insulation: Extruded special compound  
Shield: One side plastic coated with aluminium strip, metal exterior with contact to tin-plated copper braid and stranded  
Drain wire  
Diameter: < 8 mm  
Conductor: 18/7 AWG (0.8 mm<sup>2</sup>), stranded blank copper



# FOUNDATION fieldbus™ – cables, Cable FBY49...



**TURCK**

Industrial Automation

M12 x 1	Type designation cable type FBY49x, x = colour (BU, BK, OG, YE), *M = variable length in m (see type code)				
	<b>einseitig vorkonfektioniert</b>	<b>RSCV</b>	<b>WSCV</b>	<b>RKCV</b>	<b>WKCV</b>
<b>RSCV</b>	RSCV-FBY49x-*M/5D	RSCV-RSCV-FBY49x-*M/5D	—	RSCV-RKCV-FBY49x-*M/5D	—
<b>WSCV</b>	WSCV-FBY49x-*M/5D	—	WSCV-WSCV-FBY49x-*M/5D	—	WSCV-WKCV-FBY49x-*M/5D
<b>RKCV</b>	RKCV-FBY49x-*M/5D	—	—	RKCV-RKCV-FBY49x-*M/5D	—
<b>WKCV</b>	WKCV-FBY49x-*M/5D	—	—	—	WKCV-WKCV-FBY49x-*M/5D

**Pin configuration:**

Male Female

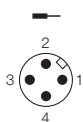

1 = + (BN)  
2 = - (BU)  
3 = S (Shield)  
4 = n.c.

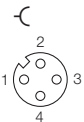

1 = + (BN)  
2 = - (BU)  
3 = S (Shield)  
4 = n.c.

7/8"	Type designation cable type FBY49x, x = colour (BU, BK, OG, YE), *M = variable length in m (see type code)				
	<b>einseitig vorkonfektioniert</b>	<b>RSV</b>	<b>WSV</b>	<b>RKV</b>	<b>WKV</b>
<b>RSV</b>	RSV-FBY49x-*M/5D	RSV-RSV-FBY49x-*M/5D	—	RSV-RKV-FBY49x-*M/5D	—
<b>WSV</b>	WSV-FBY49x-*M/5D	—	WSV-WSV-FBY49x-*M/5D	—	WSV-WKV-FBY49x-*M/5D
<b>RKV</b>	RKV-FBY49x-*M/5D	—	—	RKV-RKV-FBY49x-*M/5D	—
<b>WKV</b>	WKV-FBY49x-*M/5D	—	—	—	WKV-WKV-FBY49x-*M/5D

**Pin configuration:**

Male Female



1 = + (BN)  
2 = - (BU)  
3 = S (Shield)  
4 = n.c.



1 = + (BN)  
2 = - (BU)  
3 = S (Shield)  
4 = n.c.

**Connectors**

Coupling nut: Stainless steel  
Contacts: Gold-plated  
Grip: PA  
Protection degree: IP67

**Cable layout**

Outer jacket: Polyvinyl chloride (PVC)  
Core isolation: PE-foam with PR-jacket  
Colour code: BN, BU  
Insulation: Extruded special compound  
Shield: One side plastic coated with aluminium strip, metal exterior with contact to tin-plated copper braid and stranded drain wire  
Diameter: < 8 mm  
Conductor: 18/7 AWG (0.8 mm<sup>2</sup>), stranded blank copper

A0

# Buskabel-Qualitäten PROFIBUS-DP, CAN (DeviceNet™, CANopen), Ethernet (vorkonfektionierte Leitungen ab Seite A1 – 6)

## Bus Cable Materials PROFIBUS-DP, CAN (DeviceNet™, CANopen), Ethernet (premoulded cables from page A1 – 6 onwards)

Feldbus Fieldbus	Kabeltyp Cable type	Abb. Fig.	Material Kabelmantel Material cable jacket	Halogenfrei Halogen-free	Schleppkettenfähig Suited to trailing applications	Data pair		
						Leiterquerschnitt Connection profile [mm <sup>2</sup> ]	Nennstrom Rated current [A]	DC-Widerstand DC resistance [Ω/Km]
PROFIBUS-DP	451	(A)	TPUS	•	• <sup>1)</sup>	2 x 0.34	4	50
	452	(B)	PVC	–	–	2 x 0.34	4	50
DeviceNet™, CANopen	572	(C)	PVC	–	–	2 x 0.21	6.4	54.1
	5711	(D)	PVC	–	–	2 x 0.52	9.6	34.1
	5723	(D)	PUR	–	• <sup>2)</sup>	2 x 0.52	9.6	34.1
Ethernet Leitungen/cables gem./acc. to ISO/IEC 11801, CAT 5	441/S2174	(E)	PUR	–	• <sup>3)</sup>	4 x 0.32	4	53
	841	(F)	PVC	–	•	8 x 0.21	1.5	94
	843	(F)	PVC	–	–	8 x 0.21	1.5	94

- 1) Biegeradius: einmalig > 45 mm, mehrmalig > 65 mm, 5 Mio. Biegezyklen ( $a_{max} = 4 \text{ m/s}^2$ )  
bending radius: once > 45 mm, repeated > 65 mm, 5 mill. bending cycles ( $a_{max} = 4 \text{ m/s}^2$ )
- 2) Biegeradius: 6,5 inch = 165 mm, 10 Mio. Biegezyklen/  
bending radius: 6,5 inch = 165 mm, 10 mill. bending cycles
- 3) Biegeradius: einmalig > 33 mm, mehrmalig > 46 mm, 5 Mio. Biegezyklen ( $\varnothing 200 \text{ mm}$ )  
bending radius: once > 33 mm, repeated > 46 mm, 5 mill. bending cycles ( $\varnothing 200 \text{ mm}$ )

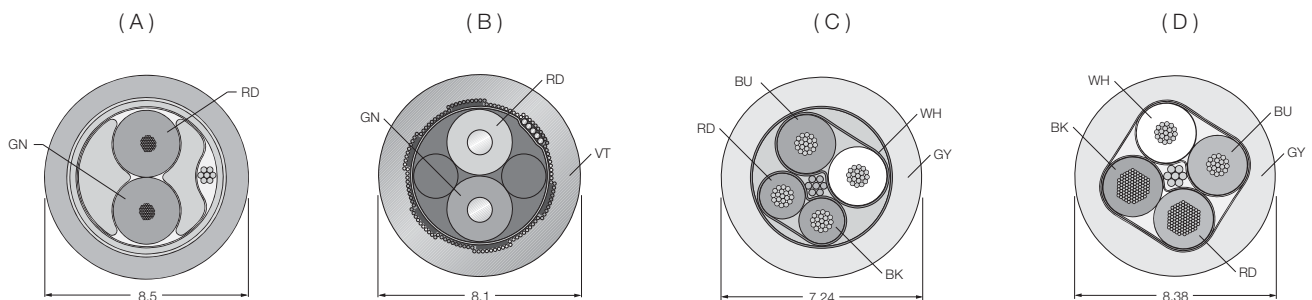

	Power pair			Nennwerte Ratings	Nom. Impedanz Power pair nom. impedance Power pair [Ω]	Nom. Kapazität Power pair nom. capacitance Power pair [pF/m]	Schirmung Shield	Zulassungen Approvals
	Leiterquerschnitt Connection profile [mm <sup>2</sup> ]	Nennstrom Rated current [A]	DC-Widerstand DC resistance [Ω/Km]					
	-	-	-	300 V, 80 °C	150 (3...20 MHz)	30	•	-
				300 V, 75 °C	110 (1 MHz)	30	•	UL
	2 x 0.33	6.4	54.1	300 V, 75 °C	126 (1 MHz)	37.17	•	UL, CSA
	2 x 1.3	15.2	13.5	300 V, 75 °C	110 (1 MHz)	40.52	•	UL, CSA
	2 x 1.04	13.6	16.9	300 V, 80 °C	110 (1 MHz)	40.52	•	UL, CSA
	-	-	-	300 V, 75 °C	120 (1 MHz)	52	•	UL
	-	-	-	300 V, 75 °C	100 (1 MHz)	46	•	UL
	-	-	-	300 V, 75 °C	100 (1 MHz)	46	•	UL

**A1**

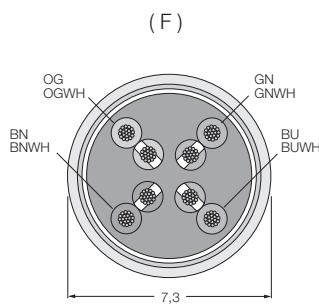
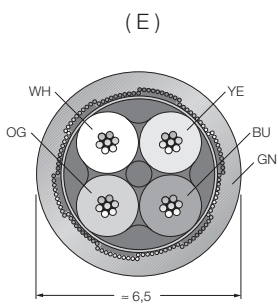

**Versorgungskabel-Qualitäten PROFIBUS-DP, CAN (DeviceNet™, CANopen)**  
**(vorkonfektionierte Leitungen ab Seite A2 – 2)**  
**Power Cable Materials PROFIBUS-DP, CAN (DeviceNet™, CANopen)**  
**(premoulded cables from page A2 – 2 onwards)**

Nutzbar für Gerätefamilien (Bussystem) Usable for product family (Bus system)	Kabeltyp Cable type	Abb. Fig.	Material Kabelmantel Material cable jacket	Halogenfrei Halogen-free	Schleppkettenfähig Suited to trailing applications	Leiter-Querschnitt Connection profile  [mm <sup>2</sup> ]
BL67, FLDP, PDP, FXDP, FENP	52	(G)	PUR	•	•	5 x 1.5
FDN...	43	(H)	PUR	•	•	4 x 1.5

(G)

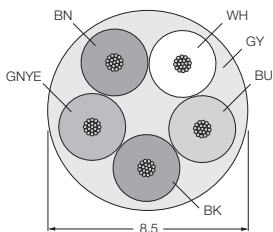

(H)

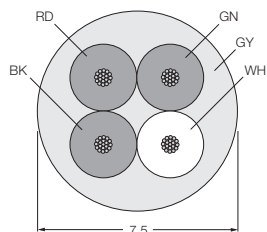

	Nennstrom Rated current  [A]	DC-Widerstand DC resistance  [Ω/Km]	Nennwerte Ratings	Nom. Impedanz Power pair nom. impedance Power pair  [Ω]	Nom.Kapazität Power pair nom. capacitance Power pair  [pF/m]	Schirmung Shield	Zulassungen Approvals
	15	13.3	240 V, 90 °C	-	-	-	-
	15	13.3	240 V, 90 °C	-	-	-	-

# Vorkonfektionierte Buskabel für PROFIBUS-DP, Typ 451, 452

## Premoulded Bus Cables for PROFIBUS-DP, Type 451, 452

Konfektionierbare Steckverbinder siehe Seite A3 – 4  
Field wireable connectors see page A3 – 4

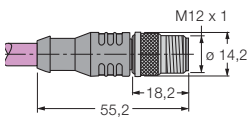
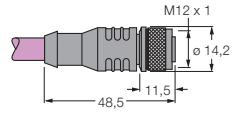
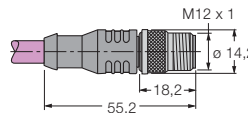
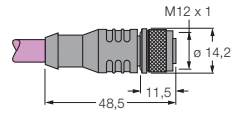
Abmessungen/Bauform Dimensions/Housing style  [mm]	Kabeltyp Cable type	Kabellänge Cable length  [m]	Werkstoffe/Materials		
			Kabelmantel Cable jacket	Überwurfmutter Coupling nut	Griffteil Grip
Kabel-Meterware Bulk cable	451	30	TPUS		
	451	150	TPUS		
	451	500	TPUS		
	452	30	PVC		
	452	150	PVC		
	452	500	PVC		
	451	1	TPUS	CuZn-Ni	PUR
	451	2	TPUS	CuZn-Ni	PUR
	451	3	TPUS	CuZn-Ni	PUR
	451	6	TPUS	CuZn-Ni	PUR
	451	10	TPUS	CuZn-Ni	PUR
	451	15	TPUS	CuZn-Ni	PUR
	451	20	TPUS	CuZn-Ni	PUR
	451	6	TPUS	CuZn-Ni	PUR
	451	10	TPUS	CuZn-Ni	PUR
	451	15	TPUS	CuZn-Ni	PUR
	451	6	TPUS	CuZn-Ni	PUR
	451	10	TPUS	CuZn-Ni	PUR
	451	15	TPUS	CuZn-Ni	PUR
	451	20	TPUS	CuZn-Ni	PUR
 	451	0.2	TPUS	CuZn-Ni	PUR
	451	0.3	TPUS	CuZn-Ni	PUR
	451	0.5	TPUS	CuZn-Ni	PUR
	451	1	TPUS	CuZn-Ni	PUR
	451	1,5	TPUS	CuZn-Ni	PUR
	451	2	TPUS	CuZn-Ni	PUR
	451	3	TPUS	CuZn-Ni	PUR
	451	4	TPUS	CuZn-Ni	PUR
	451	5	TPUS	CuZn-Ni	PUR
	451	6	TPUS	CuZn-Ni	PUR
	451	7	TPUS	CuZn-Ni	PUR
	451	8	TPUS	CuZn-Ni	PUR
	451	10	TPUS	CuZn-Ni	PUR
	451	12	TPUS	CuZn-Ni	PUR
	451	15	TPUS	CuZn-Ni	PUR
	451	30	TPUS	CuZn-Ni	PUR

### Anschlussbelegung Pin Configuration

C071

C072

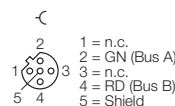
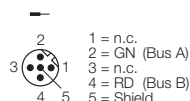

<sup>1)</sup> B = invers codiert gem. PNO-Richtlinie/reverse keyed acc. to PNO directive

Typenbezeichnung Type	Ident-Nr. Ident no.	Anschluss Connection	Steckverbinder- codierung Connector coding	Schleppkettenfähig Suited to trailing applications	Zulassungen Approvals	Schutzart Degree of protection
<b>KABEL451-30M</b>	6915601			•	–	
<b>KABEL451-150M</b>	6915603			•	–	
<b>KABEL451-500M</b>	6915606			•	–	
<b>KABEL452-30M</b>	6611474			–	UL	
<b>KABEL452-150M</b>	6611475			–	UL	
<b>KABEL452-300M</b>	6611476			–	UL	
<b>RSSW451-1M</b>	8029320	C071	B <sup>1</sup> )	•	–	IP67
<b>RSSW451-2M</b>	6914229	C071	B <sup>1</sup> )	•	–	IP67
<b>RSSW451-3M</b>	6914402	C071	B <sup>1</sup> )	•	–	IP67
<b>RSSW451-6M</b>	6914111	C071	B <sup>1</sup> )	•	–	IP67
<b>RSSW451-10M</b>	6914112	C071	B <sup>1</sup> )	•	–	IP67
<b>RSSW451-15M</b>	6914113	C071	B <sup>1</sup> )	•	–	IP67
<b>RSSW451-20M</b>	6914228	C071	B <sup>1</sup> )	•	–	IP67
<b>RKSW451-1M</b>	6915609	C072	B <sup>1</sup> )	•	–	IP67
<b>RKSW451-2M</b>	6915611	C072	B <sup>1</sup> )	•	–	IP67
<b>RKSW451-3M</b>	6915613	C072	B <sup>1</sup> )	•	–	IP67
<b>RKSW451-6M</b>	6914114	C072	B <sup>1</sup> )	•	–	IP67
<b>RKSW451-10M</b>	6914115	C072	B <sup>1</sup> )	•	–	IP67
<b>RKSW451-15M</b>	6914116	C072	B <sup>1</sup> )	•	–	IP67
<b>RKSW451-20M</b>	8030688	C072	B <sup>1</sup> )	•	–	IP67
<b>RSSW-RKSW451-0,2M</b>	6915901	C071 / C072	B <sup>1</sup> )	•	–	IP67 / IP67
<b>RSSW-RKSW451-0,3M</b>	6915655	C071 / C072	B <sup>1</sup> )	•	–	IP67 / IP67
<b>RSSW-RKSW451-0,5M</b>	6914117	C071 / C072	B <sup>1</sup> )	•	–	IP67 / IP67
<b>RSSW-RKSW451-1M</b>	6914118	C071 / C072	B <sup>1</sup> )	•	–	IP67 / IP67
<b>RSSW-RKSW451-1,5M</b>	6915656	C071 / C072	B <sup>1</sup> )	•	–	IP67 / IP67
<b>RSSW-RKSW451-2M</b>	6914119	C071 / C072	B <sup>1</sup> )	•	–	IP67 / IP67
<b>RSSW-RKSW451-3M</b>	6915658	C071 / C072	B <sup>1</sup> )	•	–	IP67 / IP67
<b>RSSW-RKSW451-4M</b>	6914120	C071 / C072	B <sup>1</sup> )	•	–	IP67 / IP67
<b>RSSW-RKSW451-5M</b>	6915669	C071 / C072	B <sup>1</sup> )	•	–	IP67 / IP67
<b>RSSW-RKSW451-6M</b>	6914121	C071 / C072	B <sup>1</sup> )	•	–	IP67 / IP67
<b>RSSW-RKSW451-7M</b>	6914206	C071 / C072	B <sup>1</sup> )	•	–	IP67 / IP67
<b>RSSW-RKSW451-8M</b>	6915660	C071 / C072	B <sup>1</sup> )	•	–	IP67 / IP67
<b>RSSW-RKSW451-10M</b>	6914122	C071 / C072	B <sup>1</sup> )	•	–	IP67 / IP67
<b>RSSW-RKSW451-12M</b>	8029319	C071 / C072	B <sup>1</sup> )	•	–	IP67 / IP67
<b>RSSW-RKSW451-15M</b>	6914123	C071 / C072	B <sup>1</sup> )	•	–	IP67 / IP67
<b>RSSW-RKSW451-30M</b>	6914124	C071 / C072	B <sup>1</sup> )	•	–	IP67 / IP67

**A1**

# Vorkonfektionierte Buskabel für PROFIBUS-DP, Typ 451

## Premoulded Bus Cables for PROFIBUS-DP, Type 451

Konfektionierbare Steckverbinder siehe Seite A3 – 4  
Field wireable connectors see page A3 – 4

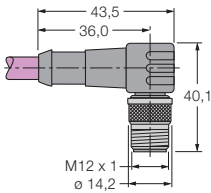
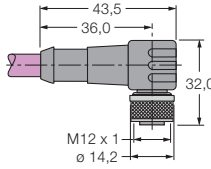
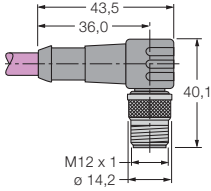
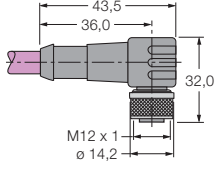
Abmessungen/Bauform Dimensions/Housing style  [mm]	Kabeltyp Cable type	Kabellänge Cable length  [m]	Werkstoffe/Materials		
			Kabelmantel Cable jacket	Überwurfmutter Coupling nut	Griffteil Grip
	451	6	TPUS	CuZn-Ni	PUR
	451	10	TPUS	CuZn-Ni	PUR
	451	15	TPUS	CuZn-Ni	PUR
	451	2	TPUS	CuZn-Ni	PUR
	451	6	TPUS	CuZn-Ni	PUR
	451	10	TPUS	CuZn-Ni	PUR
	451	15	TPUS	CuZn-Ni	PUR
 	451	0.3	TPUS	CuZn-Ni	PUR
	451	0.5	TPUS	CuZn-Ni	PUR
	451	1	TPUS	CuZn-Ni	PUR
	451	2	TPUS	CuZn-Ni	PUR
	451	4	TPUS	CuZn-Ni	PUR
	451	6	TPUS	CuZn-Ni	PUR
	451	10	TPUS	CuZn-Ni	PUR
	451	15	TPUS	CuZn-Ni	PUR
	451	30	TPUS	CuZn-Ni	PUR

### Anschlussbelegung Pin Configuration

C071

C072

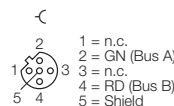
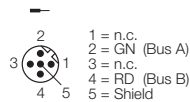

<sup>1)</sup> B = invers codiert gem. PNO-Richtlinie/reverse keyed acc. to PNO directive



Typenbezeichnung Type	Ident-Nr. Ident no.	Anschluss Connection	Steckverbinder- codierung Connector coding	Schleppkettenfähig Suited to trailing applications	Zulassungen Approvals	Schutzart Degree of protection
<b>WSSW451-6M</b>	6914128	C071	B <sup>1</sup> )	•	–	IP67
<b>WSSW451-10M</b>	6914129	C071	B <sup>1</sup> )	•	–	IP67
<b>WSSW451-15M</b>	6914130	C071	B <sup>1</sup> )	•	–	IP67
<b>WKSW451-2M</b>	6914209	C072	B <sup>1</sup> )	•	–	IP67
<b>WKSW451-6M</b>	6914131	C072	B <sup>1</sup> )	•	–	IP67
<b>WKSW451-10M</b>	6914132	C072	B <sup>1</sup> )	•	–	IP67
<b>WKSW451-15M</b>	6914133	C072	B <sup>1</sup> )	•	–	IP67
<b>WSSW-WKSW451-0,3M</b>	6915680	C071 / C072	B <sup>1</sup> )	•	–	IP67 / IP67
<b>WSSW-WKSW451-0,5M</b>	6914134	C071 / C072	B <sup>1</sup> )	•	–	IP67 / IP67
<b>WSSW-WKSW451-1M</b>	6914135	C071 / C072	B <sup>1</sup> )	•	–	IP67 / IP67
<b>WSSW-WKSW451-2M</b>	6914136	C071 / C072	B <sup>1</sup> )	•	–	IP67 / IP67
<b>WSSW-WKSW451-4M</b>	6914137	C071 / C072	B <sup>1</sup> )	•	–	IP67 / IP67
<b>WSSW-WKSW451-6M</b>	6914138	C071 / C072	B <sup>1</sup> )	•	–	IP67 / IP67
<b>WSSW-WKSW451-10M</b>	6914139	C071 / C072	B <sup>1</sup> )	•	–	IP67 / IP67
<b>WSSW-WKSW451-15M</b>	6914140	C071 / C072	B <sup>1</sup> )	•	–	IP67 / IP67
<b>WSSW-WKSW451-30M</b>	6914141	C071 / C072	B <sup>1</sup> )	•	–	IP67 / IP67

**A1**

# Vorkonfektionierte Buskabel für PROFIBUS-DP, Typ 451

## Premoulded Bus Cables for PROFIBUS-DP, Type 451

Konfektionierbare Steckverbinder siehe Seite A3 – 4  
Field wireable connectors see page A3 – 4

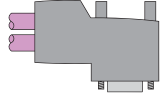
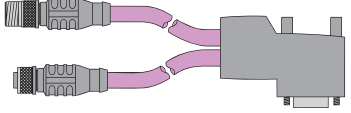
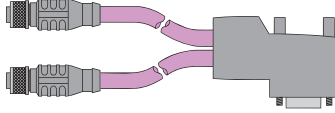
Abmessungen/Bauform Dimensions/Housing style  [mm]	Kabeltyp Cable type	Kabellänge Cable length  [m]	Werkstoffe/Materials/Materiaux		
			Kabelmantel Cable jacket	Überwurfmutter Coupling nut	Griffteil Grip
	451	0.5 / 0.5	TPUS		
	451	1 / 1	TPUS		
	451	2 / 2	TPUS		
	451	0.3 / 0.3	TPUS	CuZn-Ni	PUR
	451	0.5 / 0.5	TPUS	CuZn-Ni	PUR
	451	0.5 / 1.5	TPUS	CuZn-Ni	PUR
	451	1 / 1	TPUS	CuZn-Ni	PUR
	451	1.5 / 1.5	TPUS	CuZn-Ni	PUR
	451	2 / 2	TPUS	CuZn-Ni	PUR
	451	3 / 3	TPUS	CuZn-Ni	PUR
	451	0.3 / 0.3	TPUS	CuZn-Ni	PUR
	451	0.5 / 0.5	TPUS	CuZn-Ni	PUR
	451	1 / 1	TPUS	CuZn-Ni	PUR
	451	2 / 2	TPUS	CuZn-Ni	PUR

### Anschlussbelegung Pin Configuration

**C064**

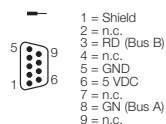

**C071**

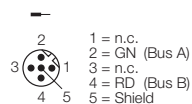

**C072**

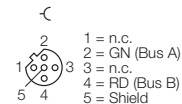

<sup>1)</sup> B = invers codiert gem. PNO-Richtlinie/reverse keyed acc. to PNO directive

Typenbezeichnung Type	Ident-Nr. Ident no.	Anschluss Connection	Steckverbinder Codierung Connector coding	Schleppkettenfähig Suited to trailing applications	Zulassungen Approvals	Schutzart Degree of protection
<b>D9-451-0,5M-0,5M</b>	6915747	C064		•	–	IP20
<b>D9-451-1M-1M</b>	6915748	C064		•	–	IP20
<b>D9-451-2M-2M</b>	6915749	C064		•	–	IP20
<b>RSSW-D9-RKSW-451-0,3M-0,3M</b>	6914125	C064 / C071 / C072	B <sup>1</sup> )	•	–	IP20 / IP67
<b>RSSW-D9-RKSW-451-0,5M-0,5M</b>	6915741	C064 / C071 / C072	B <sup>1</sup> )	•	–	IP20 / IP67
<b>RSSW-D9-RKSW-451-0,5M-1,5M</b>	8030192	C064 / C071 / C072	B <sup>1</sup> )	•	–	IP20 / IP67
<b>RSSW-D9-RKSW-451-1M-1M</b>	6914126	C064 / C071 / C072	B <sup>1</sup> )	•	–	IP20 / IP67
<b>RSSW-D9-RKSW-451-1,5M-1,5M</b>	6915917	C064 / C071 / C072	B <sup>1</sup> )	•	–	IP20 / IP67
<b>RSSW-D9-RKSW-451-2M-2M</b>	6914127	C064 / C071 / C072	B <sup>1</sup> )	•	–	IP20 / IP67
<b>RSSW-D9-RKSW-451-3M-3M</b>	6915902	C064 / C071 / C072	B <sup>1</sup> )	•	–	IP20 / IP67
<b>RKSW-D9-RKSW-451-0,3M-0,3M</b>	6604659	C064 / C072 / C072	B <sup>1</sup> )	•	–	IP20 / IP67
<b>RKSW-D9-RKSW-451-0,5M-0,5M</b>	6915792	C064 / C072 / C072	B <sup>1</sup> )	•	–	IP20 / IP67
<b>RKSW-D9-RKSW-451-1M-1M</b>	6604661	C064 / C072 / C072	B <sup>1</sup> )	•	–	IP20 / IP67
<b>RKSW-D9-RKSW-451-2M-2M</b>	6604663	C064 / C072 / C072	B <sup>1</sup> )	•	–	IP20 / IP67

# Vorkonfektionierte Buskabel für PROFIBUS-DP, Typ 451

## Premoulded Bus Cables for PROFIBUS-DP, Type 451

Konfektionierbare Steckverbinder siehe Seite A3 – 4  
Field wireable connectors see page A3 – 4

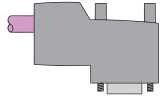
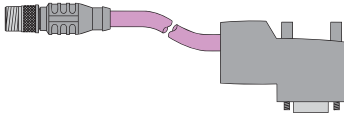
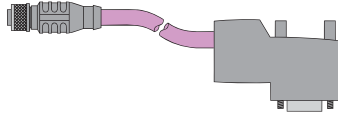
Abmessungen/Bauform Dimensions/Housing style  [mm]	Kabeltyp Cable type	Kabellänge Cable length  [m]	Werkstoffe/Materials/Materiaux		
			Kabelmantel Cable jacket	Überwurfmutter Coupling nut	Griffteil Grip
	451	0.5	TPUS		
	451	1	TPUS		
	451	2	TPUS		
	451	0.3	TPUS	CuZn-Ni	PUR
	451	0.5	TPUS	CuZn-Ni	PUR
	451	1	TPUS	CuZn-Ni	PUR
	451	2	TPUS	CuZn-Ni	PUR
	451	0.3	TPUS	CuZn-Ni	PUR
	451	0.5	TPUS	CuZn-Ni	PUR
	451	1	TPUS	CuZn-Ni	PUR
	451	2	TPUS	CuZn-Ni	PUR
	451	6	TPUS	CuZn-Ni	PUR

### Anschlussbelegung Pin Configuration

**C064**

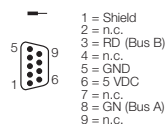

**C071**

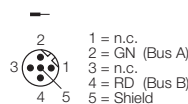

**C072**

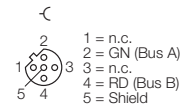

<sup>1)</sup> B = invers codiert gem. PNO-Richtlinie/reverse keyed acc. to PNO directive

Typenbezeichnung Type	Ident-Nr. Ident no.	Anschluss Connection	Steckverbinder Codierung Connector coding	Schleppkettenfähig Suited to trailing applications	Zulassungen Approvals	Schutzart Degree of protection
<b>D9T451-0,5M</b>	6915757	C064		•	–	IP20
<b>D9T451-1M</b>	6915758	C064		•	–	IP20
<b>D9T451-2M</b>	6915759	C064		•	–	IP20
<b>RSSW-D9T451-0,3M</b>	6915775	C064 / C071	B <sup>1</sup> )	•	–	IP20 / IP67
<b>RSSW-D9T451-0,5M</b>	6915777	C064 / C071	B <sup>1</sup> )	•	–	IP20 / IP67
<b>RSSW-D9T451-1M</b>	6915778	C064 / C071	B <sup>1</sup> )	•	–	IP20 / IP67
<b>RSSW-D9T451-2M</b>	6915779	C064 / C071	B <sup>1</sup> )	•	–	IP20 / IP67
<b>RKSW-D9T451-0,3M</b>	6915765	C064 / C072	B <sup>1</sup> )	•	–	IP20 / IP67
<b>RKSW-D9T451-0,5M</b>	6915767	C064 / C072	B <sup>1</sup> )	•	–	IP20 / IP67
<b>RKSW-D9T451-1M</b>	6915768	C064 / C072	B <sup>1</sup> )	•	–	IP20 / IP67
<b>RKSW-D9T451-2M</b>	6915769	C064 / C072	B <sup>1</sup> )	•	–	IP20 / IP67
<b>RKSW-D9T451-6M</b>	6914187	C064 / C072	B <sup>1</sup> )	•	–	IP20 / IP67

# Vorkonfektionierte Buskabel für DeviceNet™, Typ 572

## Premoulded Bus Cables for DeviceNet™, Type 572

Konfektionierbare Steckverbinder siehe Seite A3 – 12  
Field wireable connectors see page A3 – 12

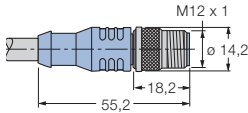
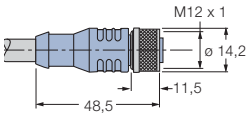
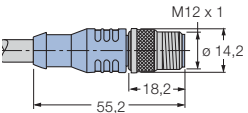
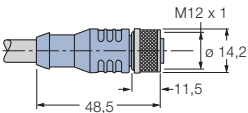
Abmessungen/Bauform Dimensions/Housing style  [mm]	Kabeltyp Cable type	Kabellänge Cable length  [m]	Werkstoffe/Materials		
			Kabelmantel Cable jacket	Überwurfmutter Coupling nut	Griffteil Grip
Kabel-Meterware Bulk cable	572	30	PVC		
	572	150	PVC		
	572	500	PVC		
	572	0.3	PVC	CuZn-Ni	PUR
	572	1.5	PVC	CuZn-Ni	PUR
	572	2	PVC	CuZn-Ni	PUR
	572	5	PVC	CuZn-Ni	PUR
	572	6	PVC	CuZn-Ni	PUR
	572	10	PVC	CuZn-Ni	PUR
	572	15	PVC	CuZn-Ni	PUR
	572	1	PVC	CuZn-Ni	PUR
	572	2	PVC	CuZn-Ni	PUR
	572	5	PVC	CuZn-Ni	PUR
	572	6	PVC	CuZn-Ni	PUR
	572	10	PVC	CuZn-Ni	PUR
	572	15	PVC	CuZn-Ni	PUR
 	572	0.3	PVC	CuZn-Ni	PUR
	572	0.5	PVC	CuZn-Ni	PUR
	572	1	PVC	CuZn-Ni	PUR
	572	2	PVC	CuZn-Ni	PUR
	572	4	PVC	CuZn-Ni	PUR
	572	6	PVC	CuZn-Ni	PUR
	572	10	PVC	CuZn-Ni	PUR
	572	15	PVC	CuZn-Ni	PUR
	572	20	PVC	CuZn-Ni	PUR
	572	30	PVC	CuZn-Ni	PUR

### Anschlussbelegung Pin Configuration

C069

C070

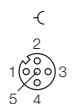

1 = Shield  
2 = RD (V+)  
3 = BK (V-)  
4 = WH (CAN H)  
5 = BU (CAN L)



1 = Shield  
2 = RD (V+)  
3 = BK (V-)  
4 = WH (CAN H)  
5 = BU (CAN L)

Typenbezeichnung Type	Ident-Nr. Ident no.	Anschluss Connection	Steckverbinder- codierung Connector coding	Schleppkettenfähig Suited to trailing applications	Zulassungen Approvals	Schutzart Degree of protection
<b>KABEL572-30M</b>	6958118			–	UL, CSA	
<b>KABEL572-150M</b>	6958120			–	UL, CSA	
<b>KABEL572-500M</b>	6604900			–	UL, CSA	
<b>RSC572-0,3M</b>	6602485	C070	A	–	UL, CSA	IP67
<b>RSC572-1,5M</b>	6602449	C070	A	–	UL, CSA	IP67
<b>RSC572-2M</b>	6602486	C070	A	–	UL, CSA	IP67
<b>RSC572-5M</b>	6602644	C070	A	–	UL, CSA	
<b>RSC572-6M</b>	6602447	C070	A	–	UL, CSA	IP67
<b>RSC572-10M</b>	6602640	C070	A	–	UL, CSA	IP67
<b>RSC572-15M</b>	6603623	C070	A	–	UL, CSA	IP67
<b>RKC572-1M</b>	6602487	C069	A	–	UL, CSA	IP67
<b>RKC572-2M</b>	6602076	C069	A	–	UL, CSA	IP67
<b>RKC572-5M</b>	6602084	C069	A	–	UL, CSA	IP67
<b>RKC572-6M</b>	6603624	C069	A	–	UL, CSA	IP67
<b>RKC572-10M</b>	6602428	C069	A	–	UL, CSA	IP67
<b>RKC572-15M</b>	6604933	C069	A	–	UL, CSA	IP67
<b>RSC-RKC572-0,3M</b>	6602473	C070 / C069	A	–	UL, CSA	IP67 / IP67
<b>RSC-RKC572-0,5M</b>	6602332	C070 / C069	A	–	UL, CSA	IP67 / IP67
<b>RSC-RKC572-1M</b>	6603628	C070 / C069	A	–	UL, CSA	IP67 / IP67
<b>RSC-RKC572-2M</b>	6603629	C070 / C069	A	–	UL, CSA	IP67 / IP67
<b>RSC-RKC572-4M</b>	6603630	C070 / C069	A	–	UL, CSA	IP67 / IP67
<b>RSC-RKC572-6M</b>	6603631	C070 / C069	A	–	UL, CSA	IP67 / IP67
<b>RSC-RKC572-10M</b>	6603632	C070 / C069	A	–	UL, CSA	IP67 / IP67
<b>RSC-RKC572-15M</b>	6603633	C070 / C069	A	–	UL, CSA	IP67 / IP67
<b>RSC-RKC572-20M</b>	6603816	C070 / C069	A	–	UL, CSA	IP67 / IP67
<b>RSC-RKC572-30M</b>	6603395	C070 / C069	A	–	UL, CSA	IP67 / IP67

**A1**

# Vorkonfektionierte Buskabel für DeviceNet™, Typ 572

## Premoulded Bus Cables for DeviceNet™, Type 572

Konfektionierbare Steckverbinder siehe Seite A3 – 12  
Field wireable connectors see page A3 – 12

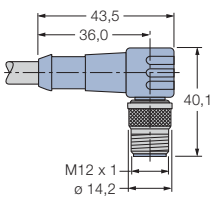
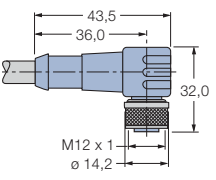
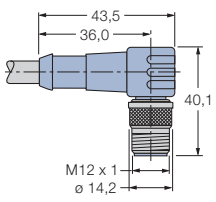
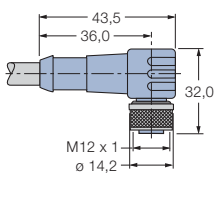
Abmessungen/Bauform Dimensions/Housing style  [mm]	Kabeltyp Cable type	Kabellänge Cable length  [m]	Werkstoffe/Materials		
			Kabelmantel Cable jacket	Überwurfmutter Coupling nut	Griffteil Grip
	572	2	PVC	CuZn-Ni	PUR
	572	6	PVC	CuZn-Ni	PUR
	572	10	PVC	CuZn-Ni	PUR
	572	15	PVC	CuZn-Ni	PUR
	572	1	PVC	CuZn-Ni	PUR
	572	2	PVC	CuZn-Ni	PUR
	572	5	PVC	CuZn-Ni	PUR
	572	6	PVC	CuZn-Ni	PUR
	572	10	PVC	CuZn-Ni	PUR
	572	15	PVC	CuZn-Ni	PUR
 	572	0.3	PVC	CuZn-Ni	PUR
	572	0.5	PVC	CuZn-Ni	PUR
	572	1	PVC	CuZn-Ni	PUR
	572	2	PVC	CuZn-Ni	PUR
	572	4	PVC	CuZn-Ni	PUR
	572	6	PVC	CuZn-Ni	PUR
	572	10	PVC	CuZn-Ni	PUR
	572	15	PVC	CuZn-Ni	PUR
	572	30	PVC	CuZn-Ni	PUR

### Anschlussbelegung Pin Configuration

C069

C070

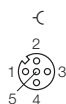

1 = Shield  
2 = RD (V+)  
3 = BK (V-)  
4 = WH (CAN H)  
5 = BU (CAN L)

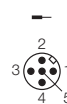

1 = Shield  
2 = RD (V+)  
3 = BK (V-)  
4 = WH (CAN H)  
5 = BU (CAN L)



Typenbezeichnung Type	Ident-Nr. Ident no.	Anschluss Connection	Steckverbinder- codierung Connector coding	Schleppkettenfähig Suited to trailing applications	Zulassungen Approvals	Schutzart Degree of protection
<b>WSC572-2M</b>	6602688	C070	A	–	UL, CSA	IP67
<b>WSC572-6M</b>	6603635	C070	A	–	UL, CSA	IP67
<b>WSC572-10M</b>	6603636	C070	A	–	UL, CSA	IP67
<b>WSC572-15M</b>	6603637	C070	A	–	UL, CSA	IP67
<b>WKC572-1M</b>	6602705	C069	A	–	UL, CSA	IP67
<b>WKC572-2M</b>	6602687	C069	A	–	UL, CSA	IP67
<b>WKC572-5M</b>	6602641	C069	A	–	UL, CSA	IP67
<b>WKC572-6M</b>	6603638	C069	A	–	UL, CSA	IP67
<b>WKC572-10M</b>	6602637	C069	A	–	UL, CSA	IP67
<b>WKC572-15M</b>	6603640	C069	A	–	UL, CSA	IP67
<b>WSC-WKC572-0,3M</b>	6603608	C070 / C069	A	–	UL, CSA	IP67 / IP67
<b>WSC-WKC572-0,5M</b>	6602024	C070 / C069	A	–	UL, CSA	IP67 / IP67
<b>WSC-WKC572-1M</b>	6602027	C070 / C069	A	–	UL, CSA	IP67 / IP67
<b>WSC-WKC572-2M</b>	6602030	C070 / C069	A	–	UL, CSA	IP67 / IP67
<b>WSC-WKC572-4M</b>	6602542	C070 / C069	A	–	UL, CSA	IP67 / IP67
<b>WSC-WKC572-6M</b>	6603645	C070 / C069	A	–	UL, CSA	IP67 / IP67
<b>WSC-WKC572-10M</b>	6602638	C070 / C069	A	–	UL, CSA	IP67 / IP67
<b>WSC-WKC572-15M</b>	6602684	C070 / C069	A	–	UL, CSA	IP67 / IP67
<b>WSC-WKC572-30M</b>	6603648	C070 / C069	A	–	UL, CSA	IP67 / IP67

# Vorkonfektionierte Buskabel für DeviceNet™, Typ 5711

## Premoulded Bus Cables for DeviceNet™, Type 5711

Konfektionierbare Steckverbinder siehe Seite A3 – 12  
Field wireable connectors see page A3 – 12

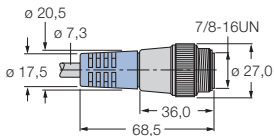
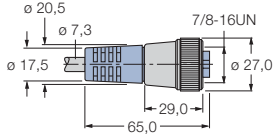
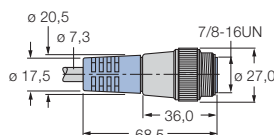
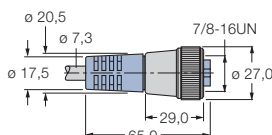
Abmessungen/Bauform Dimensions/Housing style  [mm]	Kabeltyp Cable type	Kabellänge Cable length  [m]	Werkstoffe/Materials		
			Kabelmantel Cable jacket	Überwurfmutter Coupling nut	Griffteil Grip
Kabel-Meterware Bulk cable	5711	30	PVC		
	5711	150	PVC		
	5711	500	PVC		
	5711	1	PVC	CuZn-Ni	PUR
	5711	3	PVC	CuZn-Ni	PUR
	5711	6	PVC	CuZn-Ni	PUR
	5711	10	PVC	CuZn-Ni	PUR
	5711	15	PVC	CuZn-Ni	PUR
	5711	1	PVC	CuZn-Ni	PUR
	5711	6	PVC	CuZn-Ni	PUR
	5711	10	PVC	CuZn-Ni	PUR
	5711	15	PVC	CuZn-Ni	PUR
 	5711	0.3	PVC	CuZn-Ni	PUR
	5711	0.5	PVC	CuZn-Ni	PUR
	5711	1	PVC	CuZn-Ni	PUR
	5711	2	PVC	CuZn-Ni	PUR
	5711	3	PVC	CuZn-Ni	PUR
	5711	4	PVC	CuZn-Ni	PUR
	5711	6	PVC	CuZn-Ni	PUR
	5711	10	PVC	CuZn-Ni	PUR
	5711	15	PVC	CuZn-Ni	PUR
	5711	30	PVC	CuZn-Ni	PUR

### Anschlussbelegung Pin Configuration

C054

C055



1 = Shield  
2 = RD (V+)  
3 = BK (V-)  
4 = WH (CAN H)  
5 = BU (CAN L)



1 = Shield  
2 = RD (V+)  
3 = BK (V-)  
4 = WH (CAN H)  
5 = BU (CAN L)

Typenbezeichnung Type	Ident-Nr. Ident no.	Anschluss Connection	Steckverbinder- codierung Connector coding	Schleppkettenfähig Suited to trailing applications	Zulassungen Approvals	Schutzart Degree of protection
<b>KABEL5711-30M</b>	6602453			–	UL, CSA	
<b>KABEL5711-150M</b>	6602455			–	UL, CSA	
<b>KABEL5711-500M</b>	6604922			–	UL, CSA	
<b>RSM5711-1M</b>	6602043	C054		–	UL, CSA	IP67
<b>RSM5711-3M</b>	6604419	C054		–	UL, CSA	IP67
<b>RSM5711-6M</b>	6603649	C054		–	UL, CSA	IP67
<b>RSM5711-10M</b>	6603650	C054		–	UL, CSA	IP67
<b>RSM5711-15M</b>	6603651	C054		–	UL, CSA	IP67
<b>RKM5711-1M</b>	6602391	C055		–	UL, CSA	IP67
<b>RKM5711-6M</b>	6603652	C055		–	UL, CSA	IP67
<b>RKM5711-10M</b>	6603653	C055		–	UL, CSA	IP67
<b>RKM5711-15M</b>	6602395	C055		–	UL, CSA	IP67
<b>RSM-RKM5711-0,3M</b>	6602611	C054 / C055		–	UL, CSA	IP67 / IP67
<b>RSM-RKM5711-0,5M</b>	6602050	C054 / C055		–	UL, CSA	IP67 / IP67
<b>RSM-RKM5711-1M</b>	6602356	C054 / C055		–	UL, CSA	IP67 / IP67
<b>RSM-RKM5711-2M</b>	6602045	C054 / C055		–	UL, CSA	IP67 / IP67
<b>RSM-RKM5711-3M</b>	6602080	C054 / C055		–	UL, CSA	IP67 / IP67
<b>RSM-RKM5711-4M</b>	6602051	C054 / C055		–	UL, CSA	IP67 / IP67
<b>RSM-RKM5711-6M</b>	6602052	C054 / C055		–	UL, CSA	IP67 / IP67
<b>RSM-RKM5711-10M</b>	6602023	C054 / C055		–	UL, CSA	IP67 / IP67
<b>RSM-RKM5711-15M</b>	6602504	C054 / C055		–	UL, CSA	IP67 / IP67
<b>RSM-RKM5711-30M</b>	6603662	C054 / C055		–	UL, CSA	IP67 / IP67

**A1**

# Vorkonfektionierte Buskabel für DeviceNet™, Typ 5711

## Premoulded Bus Cables for DeviceNet™, Type 5711

Konfektionierbare Steckverbinder siehe Seite A3 – 12  
Field wireable connectors see page A3 – 12

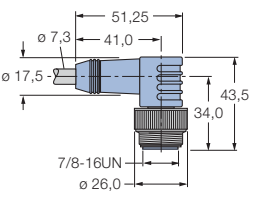
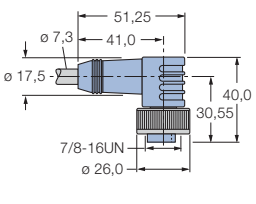
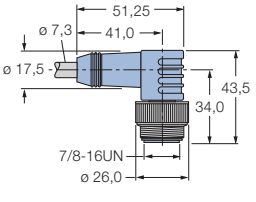
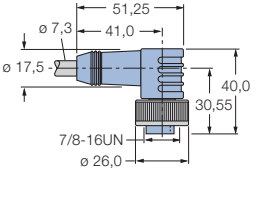
Abmessungen/Bauform Dimensions/Housing style  [mm]	Kabeltyp Cable type	Kabellänge Cable length  [m]	Werkstoffe/Materials		
			Kabelmantel Cable jacket	Überwurfmutter Coupling nut	Griffteil Grip
	5711	6	PVC	CuZn-Ni	PUR
	5711	10	PVC	CuZn-Ni	PUR
	5711	15	PVC	CuZn-Ni	PUR
	5711	6	PVC	CuZn-Ni	PUR
	5711	10	PVC	CuZn-Ni	PUR
	5711	15	PVC	CuZn-Ni	PUR
 	5711	0.3	PVC	CuZn-Ni	PUR
	5711	0.5	PVC	CuZn-Ni	PUR
	5711	1	PVC	CuZn-Ni	PUR
	5711	2	PVC	CuZn-Ni	PUR
	5711	4	PVC	CuZn-Ni	PUR
	5711	6	PVC	CuZn-Ni	PUR
	5711	10	PVC	CuZn-Ni	PUR
	5711	15	PVC	CuZn-Ni	PUR
	5711	30	PVC	CuZn-Ni	PUR

### Anschlussbelegung Pin Configuration

C054

C055



- 1 = Shield
- 2 = RD (V+)
- 3 = BK (V-)
- 4 = WH (CAN H)
- 5 = BU (CAN L)



- 1 = Shield
- 2 = RD (V+)
- 3 = BK (V-)
- 4 = WH (CAN H)
- 5 = BU (CAN L)

Type	Typenbezeichnung	Ident-Nr. Ident no.	Anschluss Connection	Steckverbinder- codierung Connector coding	Schleppkettenfähig Suited to trailing applications	Zulassungen Approvals	Schutzart Degree of protection
	<b>WSM5711-6M</b>	6606039	C054		–	UL, CSA	IP67
	<b>WSM5711-10M</b>	6602718	C054		–	UL, CSA	IP67
	<b>WSM5711-15M</b>	6603225	C054		–	UL, CSA	IP67
	<b>WKM5711-6M</b>	6605296	C055		–	UL, CSA	IP67
	<b>WKM5711-10M</b>	6605298	C055		–	UL, CSA	IP67
	<b>WKM5711-15M</b>	6605299	C055		–	UL, CSA	IP67
	<b>WSM-WKM5711-0,3M</b>	6605652	C054 / C055		–	UL, CSA	IP67 / IP67
	<b>WSM-WKM5711-0,5M</b>	6602014	C054 / C055		–	UL, CSA	IP67 / IP67
	<b>WSM-WKM5711-1M</b>	6602016	C054 / C055		–	UL, CSA	IP67 / IP67
	<b>WSM-WKM5711-2M</b>	6602018	C054 / C055		–	UL, CSA	IP67 / IP67
	<b>WSM-WKM5711-4M</b>	6605654	C054 / C055		–	UL, CSA	IP67 / IP67
	<b>WSM-WKM5711-6M</b>	6602401	C054 / C055		–	UL, CSA	IP67 / IP67
	<b>WSM-WKM5711-10M</b>	6602022	C054 / C055		–	UL, CSA	IP67 / IP67
	<b>WSM-WKM5711-15M</b>	6603447	C054 / C055		–	UL, CSA	IP67 / IP67
	<b>WSM-WKM5711-30M</b>	6605657	C054 / C055		–	UL, CSA	IP67 / IP67

# Vorkonfektionierte Buskabel für DeviceNet™, Typ 5723 Premoulded Bus Cables for DeviceNet™, Type 5723

Konfektionierbare Steckverbinder siehe Seite A3 – 12  
Field wireable connectors see page A3 – 12

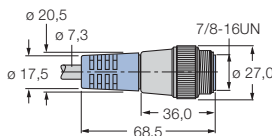
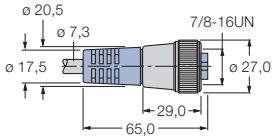
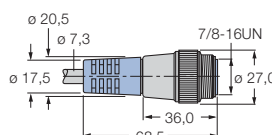
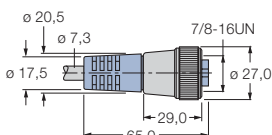
Abmessungen/Bauform Dimensions/Housing style  [mm]	Kabeltyp Cable type	Kabellänge Cable length  [m]	Werkstoffe/Materials		
			Kabelmantel Cable jacket	Überwurfmutter Coupling nut	Griffteil Grip
Kabel-Meterware Bulk cable	5723	30	PUR		
	5723	150	PUR		
	5723	500	PUR		
	5723	6	PUR	CuZn-Ni	PUR
	5723	10	PUR	CuZn-Ni	PUR
	5723	15	PUR	CuZn-Ni	PUR
	5723	6	PUR	CuZn-Ni	PUR
	5723	10	PUR	CuZn-Ni	PUR
	5723	15	PUR	CuZn-Ni	PUR
 	5723	0.3	PUR	CuZn-Ni	PUR
	5723	0.5	PUR	CuZn-Ni	PUR
	5723	1	PUR	CuZn-Ni	PUR
	5723	2	PUR	CuZn-Ni	PUR
	5723	4	PUR	CuZn-Ni	PUR
	5723	6	PUR	CuZn-Ni	PUR
	5723	10	PUR	CuZn-Ni	PUR
	5723	15	PUR	CuZn-Ni	PUR
	5723	30	PUR	CuZn-Ni	PUR

## Anschlussbelegung Pin Configuration

C054

C055



- 1 = Shield
- 2 = RD (V+)
- 3 = BK (V-)
- 4 = WH (CAN H)
- 5 = BU (CAN L)



- 1 = Shield
- 2 = RD (V+)
- 3 = BK (V-)
- 4 = WH (CAN H)
- 5 = BU (CAN L)

Typenbezeichnung Type	Ident-Nr. Ident no.	Anschluss Connection	Steckverbinder- codierung Connector coding	Schleppkettenfähig Suited to trailing applications	Zulassungen Approvals	Schutzart Degree of protection
<b>KABEL5723-30M</b>	6604923			•	UL, CSA	
<b>KABEL5723-150M</b>	6604925			•	UL, CSA	
<b>KABEL5723-500M</b>	6604928			•	UL, CSA	
<b>RSM5723-6M</b>	6605933	C054		•	UL, CSA	IP67
<b>RSM5723-10M</b>	6605935	C054		•	UL, CSA	IP67
<b>RSM5723-15M</b>	6605936	C054		•	UL, CSA	IP67
<b>RKM5723-6M</b>	6605189	C055		•	UL, CSA	IP67
<b>RKM5723-10M</b>	6605191	C055		•	UL, CSA	IP67
<b>RKM5723-15M</b>	6605192	C055		•	UL, CSA	IP67
<b>RSM-RKM5723-0,3M</b>	6605544	C054 / C055		•	UL, CSA	IP67 / IP67
<b>RSM-RKM5723-0,5M</b>	6605545	C054 / C055		•	UL, CSA	IP67 / IP67
<b>RSM-RKM5723-1M</b>	6605546	C054 / C055		•	UL, CSA	IP67 / IP67
<b>RSM-RKM5723-2M</b>	6605548	C054 / C055		•	UL, CSA	IP67 / IP67
<b>RSM-RKM5723-4M</b>	6605551	C054 / C055		•	UL, CSA	IP67 / IP67
<b>RSM-RKM5723-6M</b>	6605553	C054 / C055		•	UL, CSA	IP67 / IP67
<b>RSM-RKM5723-10M</b>	6605555	C054 / C055		•	UL, CSA	IP67 / IP67
<b>RSM-RKM5723-15M</b>	6605556	C054 / C055		•	UL, CSA	IP67 / IP67
<b>RSM-RKM5723-30M</b>	6605559	C054 / C055		•	UL, CSA	IP67 / IP67

**A1**

# Vorkonfektionierte Buskabel für DeviceNet™, Typ 5723

## Premoulded Bus Cables for DeviceNet™, Type 5723

Konfektionierbare Steckverbinder siehe Seite A3 – 12  
Field wireable connectors see page A3 – 12

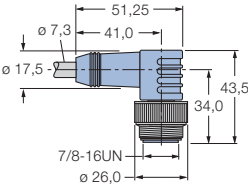
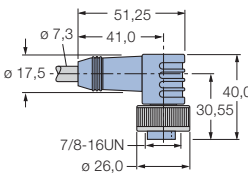
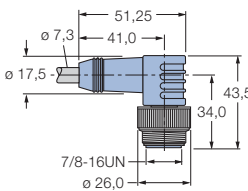
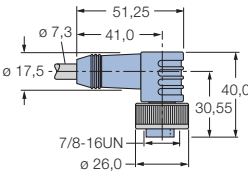
Abmessungen/Bauform Dimensions/Housing style  [mm]	Kabeltyp Cable type	Kabellänge Cable length  [m]	Werkstoffe/Materials		
			Kabelmantel Cable jacket	Überwurfmutter Coupling nut	Griffteil Grip
	5723	6	PUR	CuZn-Ni	PUR
	5723	10	PUR	CuZn-Ni	PUR
	5723	15	PUR	CuZn-Ni	PUR
	5723	6	PUR	CuZn-Ni	PUR
	5723	10	PUR	CuZn-Ni	PUR
	5723	15	PUR	CuZn-Ni	PUR
 	5723	0.3	PUR	CuZn-Ni	PUR
	5723	0.5	PUR	CuZn-Ni	PUR
	5723	1	PUR	CuZn-Ni	PUR
	5723	2	PUR	CuZn-Ni	PUR
	5723	4	PUR	CuZn-Ni	PUR
	5723	6	PUR	CuZn-Ni	PUR
	5723	10	PUR	CuZn-Ni	PUR
	5723	15	PUR	CuZn-Ni	PUR
	5723	30	PUR	CuZn-Ni	PUR

### Anschlussbelegung Pin Configuration

C054

C055



1 = Shield  
2 = RD (V+)  
3 = BK (V-)  
4 = WH (CAN H)  
5 = BU (CAN L)





1 = Shield  
2 = RD (V+)  
3 = BK (V-)  
4 = WH (CAN H)  
5 = BU (CAN L)



Typenbezeichnung Type	Ident-Nr. Ident no.	Anschluss Connection	Steckverbinder- codierung Connector coding	Schleppkettenfähig Suited to trailing applications	Zulassungen Approvals	Schutzart Degree of protection
<b>WSM5723-6M</b>	6606055	C054		•	UL, CSA	IP67
<b>WSM5723-10M</b>	6606057	C054		•	UL, CSA	IP67
<b>WSM5723-15M</b>	6606058	C054		•	UL, CSA	IP67
<b>WKM5723-6M</b>	6605314	C055		•	UL, CSA	IP67
<b>WKM5723-10M</b>	6605316	C055		•	UL, CSA	IP67
<b>WKM5723-15M</b>	6605317	C055		•	UL, CSA	IP67
<b>WSM-WKM5723-0,3M</b>	6605660	C054 / C055		•	UL, CSA	IP67 / IP67
<b>WSM-WKM5723-0,5M</b>	6605661	C054 / C055		•	UL, CSA	IP67 / IP67
<b>WSM-WKM5723-1M</b>	6605662	C054 / C055		•	UL, CSA	IP67 / IP67
<b>WSM-WKM5723-2M</b>	6605664	C054 / C055		•	UL, CSA	IP67 / IP67
<b>WSM-WKM5723-4M</b>	6605667	C054 / C055		•	UL, CSA	IP67 / IP67
<b>WSM-WKM5723-6M</b>	6605669	C054 / C055		•	UL, CSA	IP67 / IP67
<b>WSM-WKM5723-10M</b>	6605671	C054 / C055		•	UL, CSA	IP67 / IP67
<b>WSM-WKM5723-15M</b>	6605672	C054 / C055		•	UL, CSA	IP67 / IP67
<b>WSM-WKM5723-30M</b>	6605675	C054 / C055		•	UL, CSA	IP67 / IP67

# Vorkonfektionierte Buskabel für DeviceNet™, open connector (OC) Premoulded Bus Cables for DeviceNet™, open connector (OC)

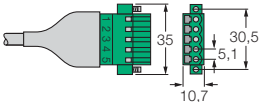
Konfektionierbare Steckverbinder siehe Seite A3 – 12  
Field wireable connectors see page A3 – 12

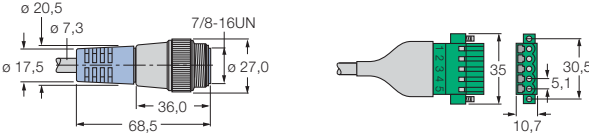
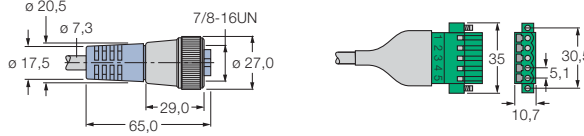
Abmessungen/Bauform Dimensions/Housing style  [mm]	Kabeltyp Cable type	Kabellänge Cable length  [m]	Werkstoffe/Materials		
			Kabelmantel Cable jacket	Überwurfmutter Coupling nut	Griffteil Grip
	572	0.5	PVC		
	572	1	PVC		
	572	2	PVC		
	5711	0.5	PVC		
	5711	1	PVC		
	5711	2	PVC		
	5723	0.5	PUR		
	5723	1	PUR		
	5723	2	PUR		
	572	0.5	PVC	CuZn-Ni	PUR
	572	1	PVC	CuZn-Ni	PUR
	572	2	PVC	CuZn-Ni	PUR
	572	4	PVC	CuZn-Ni	PUR
	572	25	PVC	CuZn-Ni	PUR
	572	0.5	PVC	CuZn-Ni	PUR
	572	1	PVC	CuZn-Ni	PUR
	572	2	PVC	CuZn-Ni	PUR
	5711	0.5	PVC	CuZn-Ni	PUR
	5711	1	PVC	CuZn-Ni	PUR
	5711	2	PVC	CuZn-Ni	PUR
	5723	0.5	PUR	CuZn-Ni	PUR
	5723	1	PUR	CuZn-Ni	PUR
	5711	0.5	PVC	CuZn-Ni	PUR
	5711	1	PVC	CuZn-Ni	PUR
	5711	2	PVC	CuZn-Ni	PUR
	5723	0.5	PUR	CuZn-Ni	PUR
	5723	1	PUR	CuZn-Ni	PUR
	5723	2	PUR	CuZn-Ni	PUR

## Anschlussbelegung Pin Configuration

C054

C055

C065

C069



1 = Shield  
2 = RD (V+)  
3 = BK (V-)  
4 = WH (CAN H)  
5 = BU (CAN L)



1 = Shield  
2 = RD (V+)  
3 = BK (V-)  
4 = WH (CAN H)  
5 = BU (CAN L)

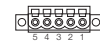

1 = BK (V-)  
2 = BU (CAN L)  
3 = Shield  
4 = WH (CAN H)  
5 = RD (V+)



1 = Shield  
2 = RD (V+)  
3 = BK (V-)  
4 = WH (CAN H)  
5 = BU (CAN L)

Typenbezeichnung Type	Ident-Nr. Ident no.	Anschluss Connection	Steckverbinder- codierung Connector coding	Schleppkettenfähig Suited to trailing applications	Zulassungen Approvals	Schutzart Degree of protection
<b>CBC5-572-0,5M</b>	6606064	C065		–	UL, CSA	IP20
<b>CBC5-572-1M</b>	6602545	C065		–	UL, CSA	IP20
<b>CBC5-572-2M</b>	6606065	C065		–	UL, CSA	IP20
<b>CBC5-5711-0,5M</b>	6606091	C065		–	UL, CSA	IP20
<b>CBC5-5711-1M</b>	6606092	C065		–	UL, CSA	IP20
<b>CBC5-5711-2M</b>	6606093	C065		–	UL, CSA	IP20
<b>CBC5-5723-0,5M</b>	6606097	C065		•	UL, CSA	IP20
<b>CBC5-5723-1M</b>	6606098	C065		•	UL, CSA	IP20
<b>CBC5-5723-2M</b>	6606099	C065		•	UL, CSA	IP20
<b>RSC-CBC5-572-0,5M</b>	6602737	C070 / C065	A	–	UL, CSA	IP67 / IP20
<b>RSC-CBC5-572-1M</b>	6606133	C070 / C065	A	–	UL, CSA	IP67 / IP20
<b>RSC-CBC5-572-2M</b>	6602340	C070 / C065	A	–	UL, CSA	IP67 / IP20
<b>RSC-CBC5-572-4M</b>	6606134	C070 / C065	A	–	UL, CSA	IP67 / IP20
<b>RSC-CBC5-572-25M</b>	6611350	C070 / C065	A	–	UL, CSA	IP67 / IP20
<b>RKC-CBC5-572-0,5M</b>	6606103	C069 / C065	A	–	UL, CSA	IP67 / IP20
<b>RKC-CBC5-572-1M</b>	6606104	C069 / C065	A	–	UL, CSA	IP67 / IP20
<b>RKC-CBC5-572-2M</b>	6606105	C069 / C065	A	–	UL, CSA	IP67 / IP20
<b>RSM-CBC5-5711-0,5M</b>	6606234	C054 / C065		–	UL, CSA	IP67 / IP20
<b>RSM-CBC5-5711-1M</b>	6606235	C054 / C065		–	UL, CSA	IP67 / IP20
<b>RSM-CBC5-5711-2M</b>	6606236	C054 / C065		–	UL, CSA	IP67 / IP20
<b>RSM-CBC5-5723-0,5M</b>	6606240	C054 / C065		•	UL, CSA	IP67 / IP20
<b>RSM-CBC5-5723-1M</b>	6606241	C054 / C065		•	UL, CSA	IP67 / IP20
<b>RSM-CBC5-5723-2M</b>	6606242	C054 / C065		•	UL, CSA	IP67 / IP20
<b>RKM-CBC5-5711-0,5M</b>	6606195	C055 / C065		–	UL, CSA	IP67 / IP20
<b>RKM-CBC5-5711-1M</b>	6606196	C055 / C065		–	UL, CSA	IP67 / IP20
<b>RKM-CBC5-5711-2M</b>	6606197	C055 / C065		–	UL, CSA	IP67 / IP20
<b>RKM-CBC5-5723-0,5M</b>	6606201	C055 / C065		•	UL, CSA	IP67 / IP20
<b>RKM-CBC5-5723-1M</b>	6606202	C055 / C065		•	UL, CSA	IP67 / IP20
<b>RKM-CBC5-5723-2M</b>	6606203	C055 / C065		•	UL, CSA	IP67 / IP20

A1

**Anschlussbelegung  
Pin Configuration**

**C070**

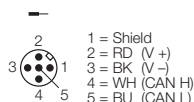

# Vorkonfektionierte Buskabel für Ethernet, Typ 441/S2174<sup>1)</sup> Premoulded Bus Cables for Ethernet, Typ 441/S2174<sup>1)</sup>

Abmessungen/Bauform Dimensions/Housing style  [mm]	Kabeltyp Cable type	Kabellänge Cable length  [m]	Werkstoffe/Materials		
			Kabelmantel Cable jacket	Überwurfmutter Coupling nut	Griffteil Grip
Kabel-Meterware Bulk cable	441/S2174	100	PUR	–	–
	441/S2174	0.5	PUR	CuZn-Ni	PUR
	441/S2174	2	PUR	CuZn-Ni	PUR
	441/S2174	6	PUR	CuZn-Ni	PUR
	441/S2174	10	PUR	CuZn-Ni	PUR
	441/S2174	20	PUR	CuZn-Ni	PUR
	441/S2174	30	PUR	CuZn-Ni	PUR
	441/S2174	0.5	PUR	CuZn-Ni	PUR
	441/S2174	1	PUR	CuZn-Ni	PUR
	441/S2174	2	PUR	CuZn-Ni	PUR
	441/S2174	6	PUR	CuZn-Ni	PUR
	441/S2174	10	PUR	CuZn-Ni	PUR
	441/S2174	15	PUR	CuZn-Ni	PUR
	441/S2174	25	PUR	CuZn-Ni	PUR
	441/S2174	40	PUR	CuZn-Ni	PUR
	441/S2174	0.5	PUR	CuZn-Ni	PUR
	441/S2174	0.5	PUR	CuZn-Ni	PUR

## Anschlussbelegung Pin Configuration

C061

C063

C067



1 = YE (TX+)  
2 = WH (RX+)  
3 = OG (TX-)  
4 = BU (RX-)



1 = YE (TX+)  
2 = WH (RX+)  
3 = OG (TX-)  
4 = BU (RX-)



1 = YE (TX+)  
2 = OG (TX-)  
3 = WH (RX+)  
4 = n.c.  
5 = n.c.  
6 = BU (RX-)  
7 = n.c.  
8 = n.c.

<sup>1)</sup> 8-polige Ethernet-Leitungen auf Anfrage/8-pole Ethernet cables on request

Typenbezeichnung Type	Ident-Nr. Ident no.	Anschluss Connection	Steckverbinder- codierung Connector coding	Schleppkettenfähig Suited to trailing applications	Zulassungen Approvals	Schutzart Degree of protection
<b>KABEL441-100M/S2174</b>	6914212	–	–	•	UL	–
<b>RSSD-RSSD-441-0,5M/S2174</b>	6914217	C061 / C061	D	•	UL	IP67 / IP67
<b>RSSD-RSSD-441-2M/S2174</b>	6914218	C061 / C061	D	•	UL	IP67 / IP67
<b>RSSD-RSSD-441-6M/S2174</b>	6914219	C061 / C061	D	•	UL	IP67 / IP67
<b>RSSD-RSSD-441-10M/S2174</b>	6914220	C061 / C061	D	•	UL	IP67 / IP67
<b>RSSD-RSSD-441-20M/S2174</b>	6914210	C061 / C061	D	•	UL	IP67 / IP67
<b>RSSD-RSSD-441-30M/S2174</b>	6914211	C061 / C061	D	•	UL	IP67 / IP67
<b>RSSD-RJ45-441-0,5M/S2174</b>	6915780	C061 / C067	D	•	UL	IP67 / IP20
<b>RSSD-RJ45-441-1M/S2174</b>	8031217	C061 / C067	D	•	UL	IP67 / IP20
<b>RSSD-RJ45-441-2M/S2174</b>	6915781	C061 / C067	D	•	UL	IP67 / IP20
<b>RSSD-RJ45-441-6M/S2174</b>	6914222	C061 / C067	D	•	UL	IP67 / IP20
<b>RSSD-RJ45-441-10M/S2174</b>	6914223	C061 / C067	D	•	UL	IP67 / IP20
<b>RSSD-RJ45-441-15M/S2174</b>	6915663	C061 / C067	D	•	UL	IP67 / IP20
<b>RSSD-RJ45-441-25M/S2174</b>	6915665	C061 / C067	D	•	UL	IP67 / IP20
<b>RSSD-RJ45-441-30M/S2174</b>	6915666	C061 / C067	D	•	UL	IP67 / IP20
<b>RSSD-RJ45-441-40M/S2174</b>	6915667	C061 / C067	D	•	UL	IP67 / IP20
<b>RJ45-FKSDD-441-0,5M/S2174</b>	6914221	C067 / C063	D	•	UL	IP20 / IP67
<b>RKSD-RJ45-441-0,5M/S2174</b>	6914224	C063 / C067	D	•	UL	IP67 / IP20

**A1**

# Vorkonfektionierte Versorgungskabel für PROFIBUS-DP, Typ 52

## Premoulded Power Cables for PROFIBUS-DP, Type 52

Konfektionierbare Steckverbinder siehe Seite A4 – 3  
Field wireable connectors see page A4 – 3

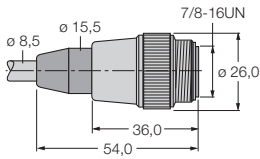
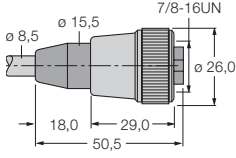
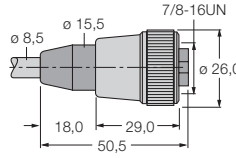
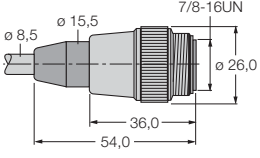
Abmessungen/Bauform Dimensions/Housing style  [mm]	Kabeltyp Cable type	Kabellänge Cable length  [m]	Werkstoffe/Materials		
			Kabelmantel Cable jacket	Überwurfmutter Coupling nut	Griffteil Grip
Kabel-Meterware Bulk cable	52	100	PUR		
	52	500	PUR		
	52	2	PUR	CuZn-Ni	PUR
	52	4	PUR	CuZn-Ni	PUR
	52	6	PUR	CuZn-Ni	PUR
	52	10	PUR	CuZn-Ni	PUR
	52	15	PUR	CuZn-Ni	PUR
	52	30	PUR	CuZn-Ni	PUR
	52	2	PUR	CuZn-Ni	PUR
	52	4	PUR	CuZn-Ni	PUR
	52	6	PUR	CuZn-Ni	PUR
	52	10	PUR	CuZn-Ni	PUR
	52	15	PUR	CuZn-Ni	PUR
	52	30	PUR	CuZn-Ni	PUR
 	52	0.3	PUR	CuZn-Ni	PUR
	52	0.5	PUR	CuZn-Ni	PUR
	52	1	PUR	CuZn-Ni	PUR
	52	2	PUR	CuZn-Ni	PUR
	52	3	PUR	CuZn-Ni	PUR
	52	4	PUR	CuZn-Ni	PUR
	52	5	PUR	CuZn-Ni	PUR
	52	6	PUR	CuZn-Ni	PUR
	52	10	PUR	CuZn-Ni	PUR
	52	15	PUR	CuZn-Ni	PUR
	52	20	PUR	CuZn-Ni	PUR
	52	30	PUR	CuZn-Ni	PUR

### Anschlussbelegung Pin Configuration

C056

C058



1 = BK (GND)  
2 = BU (GND)  
3 = GNYE (PE)  
4 = BN (UB)  
5 = WH (UL)



1 = BK (GND)  
2 = BU (GND)  
3 = GNYE (PE)  
4 = BN (UB)  
5 = WH (UL)

Typenbezeichnung Type	Ident-Nr. Ident no.	Anschluss Connection	Steckverbinder- codierung Connector coding	Schleppkettenfähig Suited to trailing applications	Zulassungen Approvals	Schutzart Degree of protection
<b>KABEL-PDP-52-100M</b>	6604716			•	–	
<b>KABEL-PDP-52-500M</b>	6604717			•	–	
<b>RSM52-2M</b>	6604712	C058		•	–	IP67
<b>RSM52-4M</b>	6604732	C058		•	–	IP67
<b>RSM52-6M</b>	6914142	C058		•	–	IP67
<b>RSM52-10M</b>	6914143	C058		•	–	IP67
<b>RSM52-15M</b>	6914144	C058		•	–	IP67
<b>RSM52-30M</b>	6604740	C058		•	–	IP67
<b>RKM52-2M</b>	6604711	C056		•	–	IP67
<b>RKM52-4M</b>	6604714	C056		•	–	IP67
<b>RKM52-6M</b>	6914145	C056		•	–	IP67
<b>RKM52-10M</b>	6914146	C056		•	–	IP67
<b>RKM52-15M</b>	6914147	C056		•	–	IP67
<b>RKM52-30M</b>	6604722	C056		•	–	IP67
<b>RKM52-0,3-RSM52</b>	6604743	C056 / C058		•	–	IP67 / IP67
<b>RKM52-0,5-RSM52</b>	6914148	C056 / C058		•	–	IP67 / IP67
<b>RKM52-1-RSM52</b>	6914149	C056 / C058		•	–	IP67 / IP67
<b>RKM52-2-RSM52</b>	6914150	C056 / C058		•	–	IP67 / IP67
<b>RKM52-3-RSM52</b>	6604749	C056 / C058		•	–	IP67 / IP67
<b>RKM52-4-RSM52</b>	6914151	C056 / C058		•	–	IP67 / IP67
<b>RKM52-5-RSM52</b>	6604751	C056 / C058		•	–	IP67 / IP67
<b>RKM52-6-RSM52</b>	6914152	C056 / C058		•	–	IP67 / IP67
<b>RKM52-10-RSM52</b>	6914153	C056 / C058		•	–	IP67 / IP67
<b>RKM52-15-RSM52</b>	6914154	C056 / C058		•	–	IP67 / IP67
<b>RKM52-20-RSM52</b>	6604756	C056 / C058		•	–	IP67 / IP67
<b>RKM52-30-RSM52</b>	6914306	C056 / C058		•	–	IP67 / IP67

# Vorkonfektionierte Versorgungskabel für PROFIBUS-DP, Typ 52

## Premoulded Power Cables for PROFIBUS-DP, Type 52

Konfektionierbare Steckverbinder siehe Seite A4 – 3  
Field wireable connectors see page A4 – 3

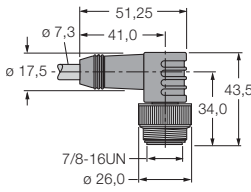
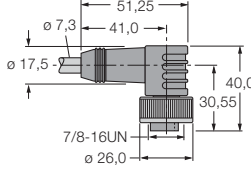
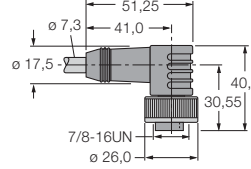
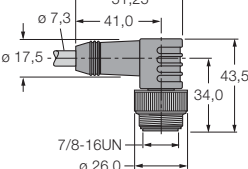
Abmessungen/Bauform Dimensions/Housing style  [mm]	Kabeltyp Cable type	Kabellänge Cable length  [m]	Werkstoffe/Materials		
			Kabelmantel Cable jacket	Überwurfmutter Coupling nut	Griffteil Grip
	52	6	PUR	CuZn-Ni	PUR
	52	10	PUR	CuZn-Ni	PUR
	52	15	PUR	CuZn-Ni	PUR
	52	0.5	PUR	CuZn-Ni	PUR
	52	2	PUR	CuZn-Ni	PUR
	52	4	PUR	CuZn-Ni	PUR
	52	6	PUR	CuZn-Ni	PUR
	52	10	PUR	CuZn-Ni	PUR
	52	15	PUR	CuZn-Ni	PUR
 	52	0.3	PUR	CuZn-Ni	PUR
	52	0.5	PUR	CuZn-Ni	PUR
	52	1	PUR	CuZn-Ni	PUR
	52	2	PUR	CuZn-Ni	PUR
	52	4	PUR	CuZn-Ni	PUR
	52	6	PUR	CuZn-Ni	PUR
	52	10	PUR	CuZn-Ni	PUR
	52	15	PUR	CuZn-Ni	PUR
	52	30	PUR	CuZn-Ni	PUR

### Anschlussbelegung Pin Configuration

C056

C058



1 = BK (GND)  
2 = BU (GND)  
3 = GNYE (PE)  
4 = BN (U<sub>B</sub>)  
5 = WH (U<sub>L</sub>)

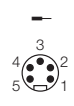

1 = BK (GND)  
2 = BU (GND)  
3 = GNYE (PE)  
4 = BN (U<sub>B</sub>)  
5 = WH (U<sub>L</sub>)



Type	Type	Ident-Nr. Ident no.	Anschluss Connection	Steckverbinder- codierung Connector coding	Schleppkettenfähig Suited to trailing applications	Zulassungen Approvals	Schutzart Degree of protection
	<b>WSM52-6M</b>	6604788	C058		•	–	IP67
	<b>WSM52-10M</b>	6604790	C058		•	–	IP67
	<b>WSM52-15M</b>	6604791	C058		•	–	IP67
	<b>WKM52-0.5M</b>	6604762	C056		•	–	IP67
	<b>WKM52-2M</b>	6604765	C056		•	–	IP67
	<b>WKM52-4M</b>	6604768	C056		•	–	IP67
	<b>WKM52-6M</b>	6604770	C056		•	–	IP67
	<b>WKM52-10M</b>	6604772	C056		•	–	IP67
	<b>WKM52-15M</b>	6604773	C056		•	–	IP67
	<b>WKM52-0,3-WSM52</b>	6604797	C056 / C058		•	–	IP67 / IP67
	<b>WKM52-0,5-WSM52</b>	6604798	C056 / C058		•	–	IP67 / IP67
	<b>WKM52-1-WSM52</b>	6604799	C056 / C058		•	–	IP67 / IP67
	<b>WKM52-2-WSM52</b>	6604801	C056 / C058		•	–	IP67 / IP67
	<b>WKM52-4-WSM52</b>	6604804	C056 / C058		•	–	IP67 / IP67
	<b>WKM52-6-WSM52</b>	6604806	C056 / C058		•	–	IP67 / IP67
	<b>WKM52-10-WSM52</b>	6604808	C056 / C058		•	–	IP67 / IP67
	<b>WKM52-15-WSM52</b>	6604809	C056 / C058		•	–	IP67 / IP67
	<b>WKM52-30-WSM52</b>	6604812	C056 / C058		•	–	IP67 / IP67

# Vorkonfektionierte Versorgungskabel für DeviceNet™, Typ 43 Premoulded Power Cables for DeviceNet™, Type 43

Konfektionierbare Steckverbinder siehe Seite A4 – 6  
Field wireable connectors see page A4 – 6

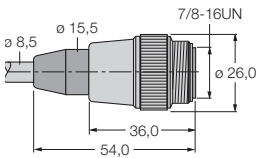
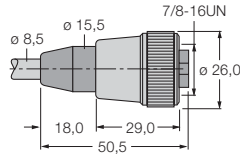
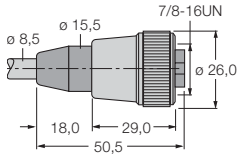
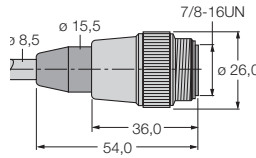
Abmessungen/Bauform Dimensions/Housing style  [mm]	Kabeltyp Cable type	Kabellänge Cable length  [m]	Werkstoffe/Materials		
			Kabelmantel Cable jacket	Überwurfmutter Coupling nut	Griffteil Grip
Kabel-Meterware Bulk cable	43	100	PUR		
	43	1000	PUR		
	43	6	PUR	CuZn-Ni	PUR
	43	10	PUR	CuZn-Ni	PUR
	43	15	PUR	CuZn-Ni	PUR
	43	6	PUR	CuZn-Ni	PUR
	43	10	PUR	CuZn-Ni	PUR
	43	15	PUR	CuZn-Ni	PUR
 	43	0.3	PUR	CuZn-Ni	PUR
	43	0.5	PUR	CuZn-Ni	PUR
	43	1	PUR	CuZn-Ni	PUR
	43	2	PUR	CuZn-Ni	PUR
	43	4	PUR	CuZn-Ni	PUR
	43	6	PUR	CuZn-Ni	PUR
	43	10	PUR	CuZn-Ni	PUR
	43	15	PUR	CuZn-Ni	PUR

## Anschlussbelegung Pin Configuration

C057

C060



1 = RD (Aux +)  
2 = GN (E +)  
3 = WH (E -)  
4 = BK (Aux -)

↺



1 = RD (Aux +)  
2 = GN (E +)  
3 = WH (E -)  
4 = BK (Aux -)

Typenbezeichnung Type	Ident-Nr. Ident no.	Anschluss Connection	Steckverbinder- codierung Connector coding	Schleppkettenfähig Suited to trailing applications	Zulassungen Approvals	Schutzart Degree of protection
<b>KABEL-DN-43-100M</b>	8037697			•	–	
<b>KABEL-DN-43-1000M</b>	8020227			•	–	
<b>RSM43-6M</b>	6915621	C057		•	–	IP67
<b>RSM43-10M</b>	6915622	C057		•	–	IP67
<b>RSM43-15M</b>	6915623	C057		•	–	IP67
<b>RKM43-6M</b>	6914307	C060		•	–	IP67
<b>RKM43-10M</b>	6914308	C060		•	–	IP67
<b>RKM43-15M</b>	6914310	C060		•	–	IP67
<b>RKM43-0,3-RSM43</b>	6914319	C060 / C057		•	–	IP67 / IP67
<b>RKM43-0,5-RSM43</b>	6914311	C060 / C057		•	–	IP67 / IP67
<b>RKM43-1-RSM43</b>	6914312	C060 / C057		•	–	IP67 / IP67
<b>RKM43-2-RSM43</b>	6914313	C060 / C057		•	–	IP67 / IP67
<b>RKM43-4-RSM43</b>	6914314	C060 / C057		•	–	IP67 / IP67
<b>RKM43-6-RSM43</b>	6914315	C060 / C057		•	–	IP67 / IP67
<b>RKM43-10-RSM43</b>	6914316	C060 / C057		•	–	IP67 / IP67
<b>RKM43-15-RSM43</b>	6914317	C060 / C057		•	–	IP67 / IP67

# Vorkonfektionierte Versorgungskabel für DeviceNet™, Typ 43 Premoulded Power Cables for DeviceNet™, Type 43

Konfektionierbare Steckverbinder siehe Seite A4 – 6  
Field wireable connectors see page A4 – 6

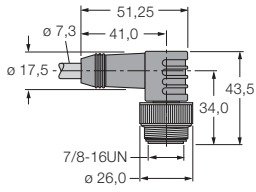
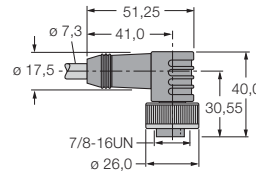
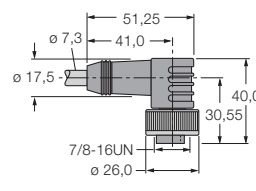
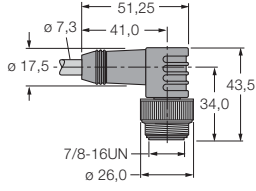
Abmessungen/Bauform Dimensions/Housing style  [mm]	Kabeltyp Cable type	Kabellänge Cable length  [m]	Werkstoffe/Materials		
			Kabelmantel Cable jacket	Überwurfmutter Coupling nut	Griffteil Grip
	43	6	PUR	CuZn-Ni	PUR
	43	10	PUR	CuZn-Ni	PUR
	43	15	PUR	CuZn-Ni	PUR
	43	6	PUR	CuZn-Ni	PUR
	43	10	PUR	CuZn-Ni	PUR
	43	15	PUR	CuZn-Ni	PUR
 	43	0.3	PUR	CuZn-Ni	PUR
	43	0.5	PUR	CuZn-Ni	PUR
	43	1	PUR	CuZn-Ni	PUR
	43	2	PUR	CuZn-Ni	PUR
	43	4	PUR	CuZn-Ni	PUR
	43	6	PUR	CuZn-Ni	PUR
	43	10	PUR	CuZn-Ni	PUR
	43	15	PUR	CuZn-Ni	PUR

## Anschlussbelegung Pin Configuration

C057

C060



1 = RD (Aux +)  
2 = GN (E +)  
3 = WH (E -)  
4 = BK (Aux -)



1 = RD (Aux +)  
2 = GN (E +)  
3 = WH (E -)  
4 = BK (Aux -)

Typenbezeichnung Type	Ident-Nr. Ident no.	Anschluss Connection	Steckverbinder- codierung Connector coding	Schleppkettenfähig Suited to trailing applications	Zulassungen Approvals	Schutzart Degree of protection
<b>WSM43-6M</b>	6915844	C057		•	–	IP67
<b>WSM43-10M</b>	6915845	C057		•	–	IP67
<b>WSM43-15M</b>	6915846	C057		•	–	IP67
<b>WKM43-6M</b>	6913940	C060		•	–	IP67
<b>WKM43-10M</b>	6913941	C060		•	–	IP67
<b>WKM43-15M</b>	6913942	C060		•	–	IP67
<b>WKM43-0,3-WSM43</b>	6913948	C060 / C057		•	–	IP67 / IP67
<b>WKM43-0,5-WSM43</b>	6913949	C060 / C057		•	–	IP67 / IP67
<b>WKM43-1-WSM43</b>	6913950	C060 / C057		•	–	IP67 / IP67
<b>WKM43-2-WSM43</b>	6913951	C060 / C057		•	–	IP67 / IP67
<b>WKM43-4-WSM43</b>	6913916	C060 / C057		•	–	IP67 / IP67
<b>WKM43-6-WSM43</b>	6913918	C060 / C057		•	–	IP67 / IP67
<b>WKM43-10-WSM43</b>	6913917	C060 / C057		•	–	IP67 / IP67
<b>WKM43-15-WSM43</b>	6913928	C060 / C057		•	–	IP67 / IP67

# Vorkonfektionierte Versorgungskabel für *piconet*<sup>®</sup> Premoulded Power Cables for *piconet*<sup>®</sup>

Konfektionierbare Steckverbinder siehe Seite A5 – 12  
Field wireable connectors see page A5 – 12

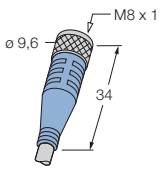
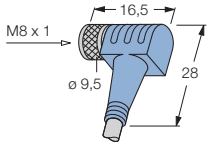
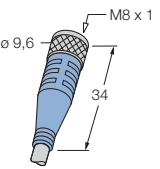
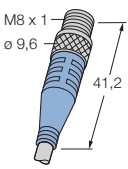
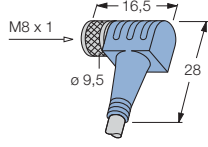
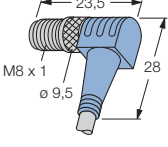
Abmessungen/Bauform Dimensions/Housing style  [mm]	Kabeltyp Cable type	Kabellänge Cable length  [m]	Werkstoffe/Materials		
			Kabelmantel Cable jacket	Überwurfmutter Coupling nut	Griffteil Grip
	IPS	2	PUR	CuZn-Ni	PUR
	IPS	5	PUR	CuZn-Ni	PUR
	IPS	10	PUR	CuZn-Ni	PUR
	IPS	2	PUR	CuZn-Ni	PUR
	IPS	5	PUR	CuZn-Ni	PUR
	IPS	10	PUR	CuZn-Ni	PUR
 	IPS	0.12	PUR	CuZn-Ni	PUR
	IPS	0.15	PUR	CuZn-Ni	PUR
	IPS	0.5	PUR	CuZn-Ni	PUR
	IPS	1	PUR	CuZn-Ni	PUR
	IPS	2	PUR	CuZn-Ni	PUR
	IPS	5	PUR	CuZn-Ni	PUR
 	IPS	0.15	PUR	CuZn-Ni	PUR
	IPS	0.5	PUR	CuZn-Ni	PUR
	IPS	1	PUR	CuZn-Ni	PUR
	IPS	2	PUR	CuZn-Ni	PUR
	IPS	5	PUR	CuZn-Ni	PUR

## Anschlussbelegung Pin Configuration

C059

C062

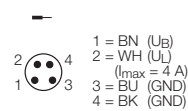
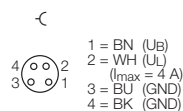

Typenbezeichnung Type	Ident-Nr. Ident no.	Anschluss Connection	Steckverbinder- codierung Connector coding	Schleppkettenfähig Suited to trailing applications	Zulassungen Approvals	Schutzart Degree of protection
<b>IPSKP4-2/S90</b>	6900323	C059		•	–	IP67
<b>IPSKP4-5/S90</b>	6900325	C059		•	–	IP67
<b>IPSKP4-10/S90</b>	6900321	C059		•	–	IP67
<b>IPSWKP4-2/S90</b>	6900331	C059		•	–	IP67
<b>IPSWKP4-5/S90</b>	6900333	C059		•	–	IP67
<b>IPSWKP4-10/S90</b>	6900329	C059		•	–	IP67
<b>IPSKP4-0,12-SSP4/S90</b>	8030976	C059 / C062		•	–	IP67 / IP67
<b>IPSKP4-0,15-SSP4/S90</b>	6900334	C059 / C062		•	–	IP67 / IP67
<b>IPSKP4-0,5-SSP4/S90</b>	6900320	C059 / C062		•	–	IP67 / IP67
<b>IPSKP4-1-SSP4/S90</b>	6900322	C059 / C062		•	–	IP67 / IP67
<b>IPSKP4-2-SSP4/S90</b>	6900324	C059 / C062		•	–	IP67 / IP67
<b>IPSKP4-5-SSP4/S90</b>	6900326	C059 / C062		•	–	IP67 / IP67
<b>IPSWKP4-0,15-SWSP4/S90</b>	6900327	C059 / C062		•	–	IP67 / IP67
<b>IPSWKP4-0,5-SWSP4/S90</b>	6900328	C059 / C062		•	–	IP67 / IP67
<b>IPSWKP4-1-SWSP4/S90</b>	6900330	C059 / C062		•	–	IP67 / IP67
<b>IPSWKP4-2-SWSP4/S90</b>	6900332	C059 / C062		•	–	IP67 / IP67
<b>IPSWKP4-5-SWSP4/S90</b>	6900319	C059 / C062		•	–	IP67 / IP67

# PROFIBUS-DP Repeater/T-Stücke/Y-Stücke Repeater/T-pieces/Y-pieces

Abmessung Dimensions [mm]	Anwendung Application	Verbindungs- technik Connection  Fig. (Fxxx)	Typenbezeichnung Type	Ident-Nr. Ident-no.
	PROFIBUS-DP Repeater, M12 B-codiert, bis 12 MBit/s, IP67 PROFIBUS-DP Repeater, M12 B-coded, up to 12 MBps, IP67	1 x 7/8" (F052) 1 x M12 (F100) 4 x M12 (F083)	<b>REP-DP 0002</b>	6825354
	Bus-T-Stück, geschirmt, 12 MBit/s Bus tee, shielded, 12 MBps	2 x M12 (F100) 1 x M12 (F083)	<b>RKSW4.5[5]-2RSSWS</b>	6999021
	Bus-T-Stück, geschirmt, 12 MBit/s, direkte T-Stück Kopplung möglich Bus tee, shielded, 12 MBps, direct coupling possible	1 x M12 (F008) 1 x M12 (F083) 1 x M12 (F100)	<b>RKSW-2RSSW45-0001</b>	6914180
	Bus-Y-Stück, komplett geschirmt, 12 MBit/s Bus Y junction, fully shielded, 12 MBps	2 x M12 (F100) 1 x M12 (F083)	<b>VB2-FSW-FKW-FSW-45<sup>1)</sup></b>	6996009

Anschlussbelegung Pin Configuration	( F008 )	( F052 )	( F083 )	( F100 )

<sup>1)</sup> Gleichzeitiger Anschluss von zwei konfektionierbaren Steckverbindern nicht möglich/Simultaneous connection of two field wireable connectors not possible



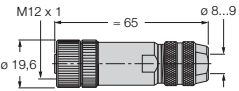
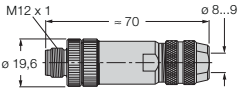
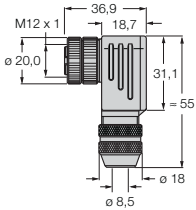
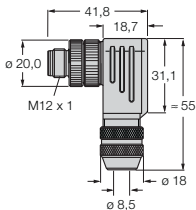

# PROFIBUS-DP Konfektionierbare Steckverbinder Field wireable Connectors

Abmessung Dimensions [mm]	Anwendung Application	Verbindungs- technik Connection  Fig. (Fxxx)	Typenbezeichnung Type	Ident-Nr. Ident-no.
	Konfektionierbare M12-Kupplung, gerade, Metallgehäuse, schirmbar Field-wireable female M12 connector, straight, metal housing, shieldable	1 x M12 (F034)	<b>FW-M12KU5W-G-ZF-ME-SH-9</b>	6604210
	Konfektionierbarer M12-Stecker, gerade, Metallgehäuse, schirmbar Field-wireable male M12 connector, straight, metal housing, shieldable	1 x M12 (F008)	<b>FW-M12ST5W-G-ZF-ME-SH-9</b>	6604211
	Konfektionierbare M12-Kupplung, abge- winkelt, Metallgehäuse, schirmbar Field-wireable female M12 connector, angled, metal housing, shieldable	1 x M12 (F034)	<b>BMWS8251-8,5</b>	6904723
	Konfektionierbarer M12-Stecker, abge- winkelt, Metallgehäuse, schirmbar Field-wireable male M12 connector, angled, metal housing, shieldable	1 x M12 (F008)	<b>BMSWS8251-8,5</b>	6904724

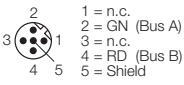
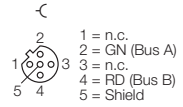
Anschlussbelegung Pin Configuration	( F008 )	( F034 )		
				

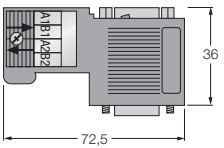
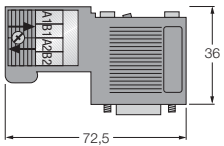
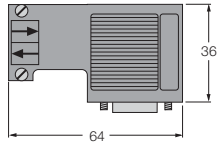
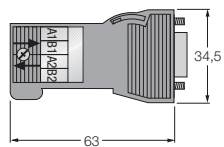
Abmessung Dimensions [mm]	Anwendung Application	Verbindungs- technik Connection Fig. (Fxxx)	Typenbezeichnung Type	Ident-Nr. Ident-no.
	Abgewinkelter Stecker und Kupplung, 12 MBit/s, Bus IN und OUT, zuschaltbarer Abschlusswiderstand, Schneid-Klemm-Anschluss-technik/Right-angled male and female connector, 12 Mbps, bus IN and OUT, selectable terminating resistor, insulation displacement connection	1 x SUB-D (C064) 1 x SUB-D (C077)	<b>6ES7972-0BB50-0XA0</b>	6780101
	Abgewinkelter Stecker, 12 MBit/s, Bus IN und OUT, zuschaltbarer Abschlusswiderstand, Schneid-Klemm-Anschluss-technik/Right-angled male connector, 12 Mbps bus IN and OUT, selectable terminating resistor, insulation displacement connection	1 x SUB-D (C064)	<b>6ES7972-0BA50-0XA0</b>	6780102
	Abgewinkelter Stecker, 12 MBit/s, Bus IN und OUT, zuschaltbarer Abschlusswiderstand, Schraub-Anschluss-technik/Right-angled male connector, 12 Mbps, bus IN and OUT, selectable terminating resistor, screw connection	1 x SUB-D (C064)	<b>6ES7972-0BA12-0XA0</b>	6890934
	Gerader Stecker, 12 MBit/s, Bus IN und OUT, zuschaltbarer Abschlusswiderstand, Schneid-Klemm-Anschluss-technik/Right-angled male connector, 12 Mbps, bus IN and OUT, selectable terminating resistor, insulation displacement connection	1 x SUB-D (C064)	<b>6GK1500-0FC00</b>	6780088

**Anschlussbelegung  
Pin Configuration**

( C064 )

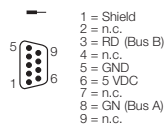

( C077 )

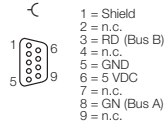

# PROFIBUS-DP Flansche (metrisches Gewinde) Flange Connectors (metric thread)

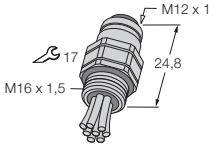
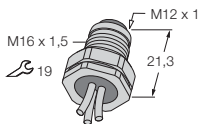
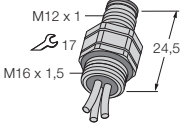
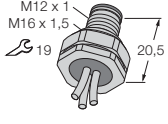
Abmessung Dimensions [mm]	Anwendung Application	Verbindungs- technik Connection Fig. (Fxxx)	Typenbezeichnung Type	Ident-Nr. Ident-no.
	<p>M12-Kupplung, B-codiert, frontseitig schraubbar (M16), drehbar, 0,5 m Litze</p> <p>Female M12 connector, B-coded, for front screw connection (M16), rotatable, 0.5 m litz wire</p>	1 x M12 (F034)	<b>EC-FKDW4.54-0,5/16</b>	8030752
	<p>M12-Kupplung, B-codiert, Rückwandmontage (M16), 0,5 m Litze</p> <p>Female M12 connector, B-coded, for back panel mounting (M16), 0.5 m litz wire</p>	1 x M12 (F034)	<b>EC-FKFDW4.54-0,5/16</b>	8030753
	<p>M12-Stecker, B-codiert, frontseitig schraubbar (M16), drehbar, 0,5 m Litze</p> <p>Female M12 connector, B-coded, for front screw connection (M16), rotatable, 0.5 m litz wire</p>	1 x M12 (F008)	<b>EC-FSDW4.54-0,5/16</b>	8030756
	<p>M12-Stecker, B-codiert, Rückwandmontage (M16), 0,5 m Litze</p> <p>Male M12 connector, B-coded, for back panel mounting (M16), 0.5 m litz wire</p>	1 x M12 (F008)	<b>EC-FSFDW4.54-0,5/16</b>	8030757

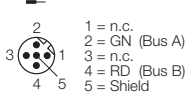
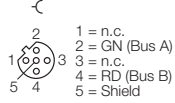
Anschlussbelegung Pin Configuration	( F008 )	( F034 )		
				

**PROFIBUS-DP Flansche (PG-Gewinde)  
Flange Connector (PG thread)**

Abmessung Dimensions [mm]	Anwendung Application	Verbindungs- technik Connection Fig. (Fxxx)	Typenbezeichnung Type	Ident-Nr. Ident-no.
	M12-Kupplung, frontseitig schraubbar, 0,5 m Litze Female M12 connector, for front screw connection, 0,5 m litz wire	1 x M12 (F034)	<b>FKW4.54-0,5</b>	8016042
	M12-Kupplung, frontseitig schraubbar, drehbar, 0,5 m Litze Female M12 connector, for front screw connection, rotatable, 0,5 m litz wire	1 x M12 (F034)	<b>FKDW4.54-0,5</b>	8015777
	M12-Kupplung, Rückwandmontage, 0,5 m Litze Female M12 connector, for back-panel mounting, 0,5 m litz wire	1 x M12 (F101)	<b>FKFDW4.54-0,5</b>	8016041
	M12-Kupplung, frontseitig schraubbar Male M12 connector, for front screw connection	1 x M12 (F034)	<b>FKW5L</b>	8016718

Anschlussbelegung Pin Configuration	( F034 )	( F101 )		

# PROFIBUS-DP Flansche (PG-Gewinde) Flange Connectors (PG thread)

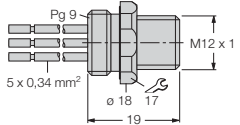
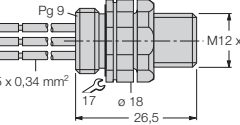
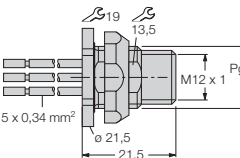
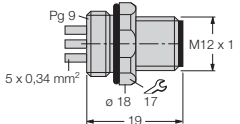
Abmessung Dimensions [mm]	Anwendung Application	Verbindungs- technik Connection Fig. (Fxxx)	Typenbezeichnung Type	Ident-Nr. Ident-no.
	M12-Stecker, frontseitig schraubbar, 0,5 m Litze Male M12 connector, for front screw connection, 0.5 m litz wire	1 x M12 (F008)	<b>FSW4.54-0,5</b>	8016038
	M12-Stecker, frontseitig schraubbar, drehbar, 0,5 m Litze Male M12 connector, for front screw connection, rotatable, 0.5 m litz wire	1 x M12 (F008)	<b>FSDW4.54-0,5</b>	8015776
	M12-Stecker, Rückwandmontage, 0,5 m Litze Male M12 connector, for back-panel mounting , 0.5 m litz wire	1 x M12 (F099)	<b>FSFDW4.54-0,5</b>	8016043
	M12-Stecker, frontseitig schraubbar Male M12 connector, for front screw connection	1 x M12 (F008)	<b>FSW5L</b>	8016717

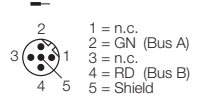
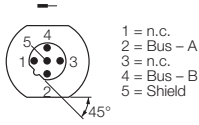
Anschlussbelegung Pin Configuration	( F008 )	( F099 )		
				

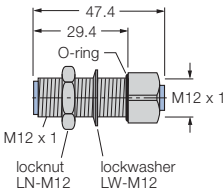
Abmessung Dimensions [mm]	Anwendung Application	Verbindungs- technik Connection Fig. (Fxxx)	Typenbezeichnung Type	Ident-Nr. Ident-no.
	<p>M12-Durchführung, Stecker, Kupplung, Lochmaß 12,7mm M12 feed-through connection male/female, through-hole 12.7 mm</p>	<p>1 x M12 (F008) 1 x M12 (F034)</p>	<b>FKW-FSW45-M12</b>	6602309

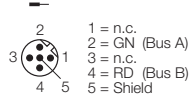
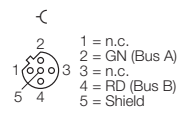
Anschlussbelegung Pin Configuration	( F008 )	( F034 )		
				

**A3**

Abmessung Dimensions [mm]	Anwendung Application	Verbindungs- technik Connection  Fig. (Fxxx)	Typenbezeichnung Type	Ident-Nr. Ident-no.
	CAN/DeviceNet Repeater, 7/8" 5-polig, bis 500 KBit/s, IP67 CAN/DeviceNet repeater, 7/8" 5-pole, up to 500 Kbps, IP67	2 x 7/8" (F060) 2 x 7/8" (F065)	<b>REP-DN</b>	6825349
	DeviceNet™-Spanner, 7/8" 5-polig, bis 128 Byte Daten, IP67 DeviceNet™ spanner, 7/8" 5-pole, up to 128 data bytes, IP67	2 x 7/8" (F060) 2 x 7/8" (F065)	<b>FDN-DN1</b>	6603596
	T-Stück für Bus und Versorgung Nicht geeignet für piconet®-Module! T piece for bus and power Not suitable for piconet® modules!	1 x 7/8" (F060) 2 x 7/8" (F065)	<b>RSM-2RKM57</b>	6602007
	T-Stück für Bus und Versorgung T piece for bus and power	1 x 7/8" (F060) 1 x 7/8" (F065) 1 x M12 (F061)	<b>RSM-FKM-RKM57</b>	6602392

Anschlussbelegung Pin Configuration	( F060 )	( F061 )	( F065 )	
	<p>           1 = Shield            2 = RD (V+)            3 = BK (V-)            4 = WH (CAN H)            5 = BU (CAN L)         </p>	<p>           1 = Shield            2 = RD (V+)            3 = BK (V-)            4 = WH (CAN H)            5 = BU (CAN L)         </p>	<p>           1 = Shield            2 = RD (V+)            3 = BK (V-)            4 = WH (CAN H)            5 = BU (CAN L)         </p>	



Abmessung Dimensions [mm]	Anwendung Application	Verbindungs- technik Connection Fig. (Fxxx)	Typenbezeichnung Type	Ident-Nr. Ident-no.
	T-Stück für Bus und Versorgung T piece for bus and power	2 x M12 (F061) 1 x M12 (F098)	<b>FSM-2FKM57</b>	6622101
	Y-Stück für Bus und Versorgung Y piece for bus and power	2 x M12 (F061) 1 x M12 (F098)	<b>VB2-FKM-FKM-FSM57</b>	6602331
	Y-Stück für Bus und Versorgung Y piece for bus and power	2 x M12 (F061) 1 x M12 (F098)	<b>VB2-RKC572-1M-FKM-FSM</b>	6996011
	Y-Stück für Bus und Versorgung Y piece for bus and power	2 x M12 (F061) 1 x M12 (F098)	<b>VB2-FKM-RKC-RSC572-0,5M-0,5M</b>	6602490

Anschlussbelegung Pin Configuration	( F061 )	( F098 )		

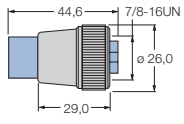
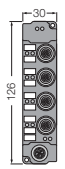
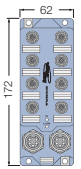

Abmessung Dimensions [mm]	Anwendung Application	Verbindungs- technik Connection  Fig. (Fxxx)	Typenbezeichnung Type	Ident-Nr. Ident-no.
	Y-Stück für Bus und Versorgung Y piece for bus and power	2 x M12 (F061) 1 x M12 (F098)	<b>VB2-FKM-FKM-RSC572-1M</b>	6602613
	Abschlusswiderstand (Stecker) Terminating resistor (male)	1 x M12 (F038)	<b>RSE57-TR2</b>	6602308
	Abschlusswiderstand (Kupplung) Terminating resistor (female)	1 x M12 (F104)	<b>RKE57-TR2</b>	6602629
	Abschlusswiderstand (Stecker) Terminating resistor (male)	1 x 7/8" (F036)	<b>RSM57-TR2</b>	6602011

Anschlussbelegung Pin Configuration	( F036 )	( F038 )	( F061 )	( F098 )	( F104 )

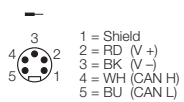
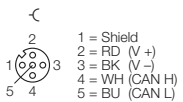
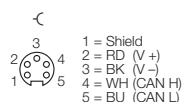
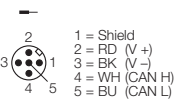
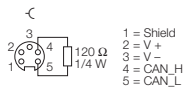
Abmessung Dimensions [mm]	Anwendung Application	Verbindungs- technik Connection Fig. (Fxxx)	Typenbezeichnung Type	Ident-Nr. Ident-no.
	Abschlusswiderstand (Kupplung) Terminating resistor (female)	1 x 7/8" (F108)	<b>RKM57-TR2</b>	6602065
	4fach-Passiv-Verteiler, IP67 4-port passive junction, IP67	1 x M12 (F098) 4 x M12 (F061)	<b>JBBS-57-E411</b>	6603378
	8fach-Passiv-Verteiler, IP67, Spannungsüberwachung 8-port passive junction, IP67, voltage monitoring	1 x 7/8" (F060) 1 x 7/8" (F065) 8 x M12 (F061)	<b>JBBS-57-E811-VM</b>	6602068

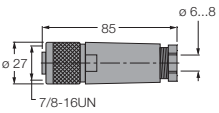
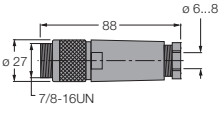
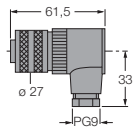
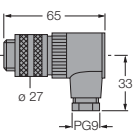
Anschlussbelegung Pin Configuration	( F060 )	( F061 )	( F065 )	( F098 )	( F108 )
					

Abmessung Dimensions [mm]	Anwendung Application	Verbindungs- technik Connection Fig. (Fxxx)	Typenbezeichnung Type	Ident-Nr. Ident-no.
	<p>Konfektionierbare 7/8"-Kupplung, Klemmbereich: 6...8 mm Field-wireable female 7/8" connector, clamping width: 6...8 mm</p>	1 x 7/8" (F065)	<b>B4151-0/9</b>	6904717
	<p>Konfektionierbarer 7/8"-Stecker, Klemmbereich: 6...8 mm Field-wireable male 7/8" connector, clamping width: 6...8 mm</p>	1 x 7/8" (F060)	<b>BS4151-0/9</b>	6904718
	<p>Konfektionierbare 7/8"-Kupplung, Klemmbereich: 6...8 mm Field-wireable female 7/8" connector, clamping width: 6...8 mm</p>	1 x 7/8" (F065)	<b>B4251-0/9</b>	6901113
	<p>Konfektionierbarer 7/8"-Stecker, Klemmbereich: 6...8 mm Field-wireable male 7/8" connector, clamping width: 6...8 mm</p>	1 x 7/8" (F060)	<b>BS4251-0/9</b>	6901112

Anschlussbelegung Pin Configuration	( F060 )	( F065 )		
	 <p>                     1 = Shield                      2 = RD (V+)                      3 = BK (V-)                      4 = WH (CAN H)                      5 = BU (CAN L)                 </p>	 <p>                     1 = Shield                      2 = RD (V+)                      3 = BK (V-)                      4 = WH (CAN H)                      5 = BU (CAN L)                 </p>		

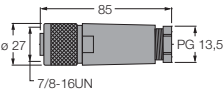
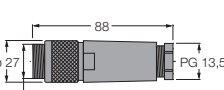
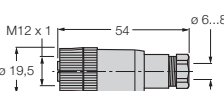
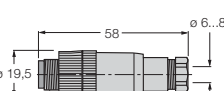
Abmessung Dimensions [mm]	Anwendung Application	Verbindungs- technik Connection Fig. (Fxxx)	Typenbezeichnung Type	Ident-Nr. Ident-no.
	Konfektionierbare 7/8"-Kupplung, Klemmbereich: 6...12 mm Field-wireable female 7/8" connector, clamping width: 6...12 mm	1 x 7/8" (F065)	<b>B4151-0/13.5</b>	6904715
	Konfektionierbarer 7/8"-Stecker, Klemmbereich: 6...12 mm Field-wireable male 7/8" connector, clamping width: 6...12 mm	1 x 7/8" (F060)	<b>BS4151-0/13.5</b>	6904716
	Konfektionierbare M12-Kupplung, Klemmbereich: 6...8 mm Field-wireable female M12 connector, clamping width: 6...8 mm	1 x M12 (F061)	<b>B8151-0/9</b>	6904604
	Konfektionierbarer M12-Stecker, Klemmbereich: 6...8 mm Field-wireable male M12 connector, clamping width: 6...8 mm	1 x M12 (F098)	<b>BS8151-0/9</b>	6904613

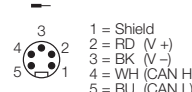
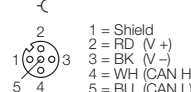
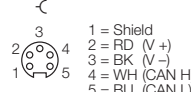
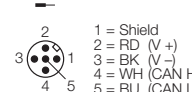
Anschlussbelegung Pin Configuration	( F060 )	( F061 )	( F065 )	( F098 )
				

Abmessung Dimensions [mm]	Anwendung Application	Verbindungs- technik Connection Fig. (Fxxx)	Typenbezeichnung Type	Ident-Nr. Ident-no.
	Konfektionierbare M12-Kupplung, Klemmbereich: 6...8 mm Field-wireable female M12 connector, clamping width: 6...8 mm	1 x M12 (F061)	<b>B8251-0/9</b>	6904603
	Konfektionierbarer M12-Stecker, Klemmbereich: 6...8 mm Field-wireable male M12 connector, clamping width: 6...8 mm	1 x M12 (F098)	<b>BS8251-0/9</b>	6904615

Anschlussbelegung Pin Configuration	( F061 )	( F098 )		
	<p>           1 = Shield            2 = RD (V +)            3 = BK (V -)            4 = WH (CAN H)            5 = BU (CAN L)         </p>	<p>           1 = Shield            2 = RD (V +)            3 = BK (V -)            4 = WH (CAN H)            5 = BU (CAN L)         </p>		

Abmessung Dimensions [mm]	Anwendung Application	Verbindungs- technik Connection Fig. (Fxxx)	Typenbezeichnung Type	Ident-Nr. Ident-no.
	Lötbare 7/8"-Flanschkupplung Solderable female 7/8" flange connector	1 x 7/8" (F065)	<b>RKF57</b>	6602217
	Lötbarer 7/8"-Flanschstecker Solderable male 7/8" flange connector	1 x 7/8" (F060)	<b>RSF57</b>	6602342
	Lötbare M12-Flanschkupplung Solderable female M12 flange connection	1 x M12 (F061)	<b>FK57</b>	6602216
	Lötbarer M12-Flanschstecker Solderable male M12 flange connection	1 x M12 (F098)	<b>FS57</b>	6602314





Anschlussbelegung Pin Configuration	( F060 )	( F061 )	( F065 )	( F098 )

Abmessung Dimensions [mm]	Anwendung Application	Verbindungs- technik Connection  Fig. (Fxxx)	Typenbezeichnung Type	Ident-Nr. Ident-no.
	<p>7/8"-Durchführung, Stecker, Kupplung, Lochmaß 22,5 mm</p> <p>7/8" feed-through connection, male, female, hole diameter 22.5 mm</p>	<p>1 x 7/8" (F060) 1 x 7/8" (F065)</p>	<b>RSF-RKF-57/22</b>	6602218
	<p>M12-Durchführung, Stecker, Kupplung, Lochmaß 12,7mm</p> <p>M12 feed-through connection male, female, hole diameter 12.7 mm</p>	<p>1 x M12 (F098) 1 x M12 (F061)</p>	<b>FKM-FS57-M12</b>	6602223

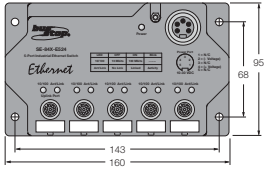
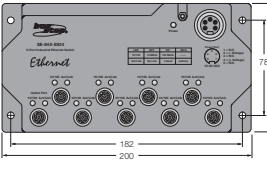
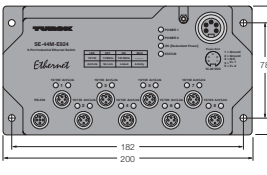
Anschlussbelegung Pin Configuration	( F060 )	( F061 )	( F065 )	( F098 )
	<p>1 = Shield 2 = RD (V +) 3 = BK (V -) 4 = WH (CAN H) 5 = BU (CAN L)</p>	<p>1 = Shield 2 = RD (V +) 3 = BK (V -) 4 = WH (CAN H) 5 = BU (CAN L)</p>	<p>1 = Shield 2 = RD (V +) 3 = BK (V -) 4 = WH (CAN H) 5 = BU (CAN L)</p>	<p>1 = Shield 2 = RD (V +) 3 = BK (V -) 4 = WH (CAN H) 5 = BU (CAN L)</p>





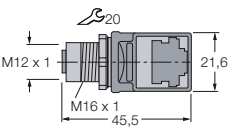
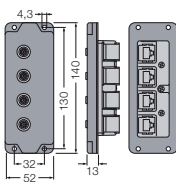
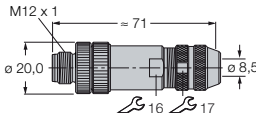
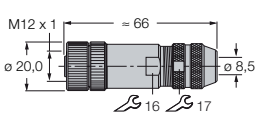
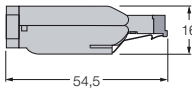

Abmessung Dimensions [mm]	Anwendung Application	Verbindungs- technik Connection Fig. (Fxxx)	Typenbezeichnung Type	Ident-Nr. Ident-no.
	5-Port Ethernet Switch, M12 D-kodiert, 10/100 MBit/s, IP67 5-port Ethernet switch, M12 D-coded, 10/100 MBps, IP67	1 x 7/8" (F006) 5 x M12 (F103)	<b>SE-44X-E524<sup>1)</sup></b>	6607003
	9 Port Ethernet Switch, M12 D-kodiert, 10/100 MBit/s, IP67 9-port Ethernet switch, M12 D-coded, 10/100 MBps, IP67	1 x 7/8" (F006) 9 x M12 (F103)	<b>SE-44X-E924<sup>1)</sup></b>	6607002
	Managebarer 8 Port Ethernet Switch, VLAN-Unterstützung, IGMP-Snooping, M12 D-kodiert, 10/100 MBit/s, IP67 Manageable 8-port Ethernet switch, VLAN support, IGMP Snooping M12 D-coded, 10/100 MBps, IP67	1 x 7/8" (F115) 8 x M12 (F103) 1 x M12 (F116)	<b>SE-44M-E924</b>	6607004

Anschlussbelegung Pin Configuration	( F006 )	( F103 )	( F115 )	( F116 )
	 <ul style="list-style-type: none"> <li>1 = n.c.</li> <li>2 = GND</li> <li>3 = n.c.</li> <li>4 = U<sub>B</sub></li> <li>5 = n.c.</li> </ul>	 <ul style="list-style-type: none"> <li>1 = YE (TX+)</li> <li>2 = WH (RX+)</li> <li>3 = OG (TX-)</li> <li>4 = BU (RX-)</li> </ul>	 <ul style="list-style-type: none"> <li>1 = GND</li> <li>2 = GND</li> <li>3 = n.c.</li> <li>4 = V+1</li> <li>5 = V+2</li> </ul>	 <ul style="list-style-type: none"> <li>1 = n.c.</li> <li>2 = TXD</li> <li>3 = GND</li> <li>4 = RXD</li> <li>5 = n.c.</li> </ul>

<sup>1)</sup> Switch auch mit 8-poliger M12-Anschluss-technik verfügbar/Switch also available with 8-pole M12 connection technology

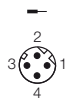
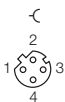
Abmessung Dimensions [mm]	Anwendung Application	Verbindungs- technik Connection  Fig. (Fxxx)	Typenbezeichnung Type	Ident-Nr. Ident-no.
	1-fach M12 D-codiert/ RJ45 Gehäusedurchführung 1-port M12 D-coded/RJ45 feed-through	1 x M12 (F103) 1 x RJ45 (F105)	<b>FKSDD-RJ45SF-44</b>	6611523
	4-fach M12 D-codiert/ RJ45-Gehäusedurchführung 4-port M12 D-coded/RJ45 feed-through	4 x M12 (F103) 4 x RJ45 (F105)	<b>BIC-44-E424<sup>1)</sup></b>	6604407
	Konfektionierbarer M12-Stecker D-codiert, gerade, Metallgehäuse, schirmbar Field-wireable male M12 connector D-coded, metall housing, shieldable	1 x M12 (C061)	<b>FW-M12ST5D-G-SB-ME-SH-8</b>	6604218
	Konfektionierbare M12-Kupplung D-codiert, gerade, Metallgehäuse, schirmbar Field-wireable female M12 connector D-coded, metall housing, shieldable	1 x M12 (C063)	<b>FW-M12KU5D-G-SB-ME-SH-8</b>	6604219
	Konfektionierbarer RJ45-Stecker, gerade, Metallgehäuse, schirmbar Field-wireable male RJ45 connector metall housing, shieldable	1 x RJ45 (C067)	<b>6GK1901-1BB10-2AA0/FC-RJ45</b>	6780031

**Anschlussbelegung  
Pin Configuration**

( C061 )	( C063 )	( C067 )	( F103 )	( F105 )
 <p>1 = YE (TX+) 2 = WH (RX+) 3 = OG (TX-) 4 = BU (RX-)</p>	 <p>1 = YE (TX+) 2 = WH (RX+) 3 = OG (TX-) 4 = BU (RX-)</p>	 <p>1 = YE (TX+) 2 = OG (TX-) 3 = WH (RX+) 4 = n.c. 5 = n.c. 6 = BU (RX-) 7 = n.c. 8 = n.c.</p>	 <p>1 = YE (TX+) 2 = WH (RX+) 3 = OG (TX-) 4 = BU (RX-)</p>	 <p>1 = YE (TX+) 2 = OG (TX-) 3 = WH (RX+) 4 = n.c. 5 = n.c. 6 = BU (RX-) 7 = n.c. 8 = n.c.</p>

<sup>1)</sup> Gehäusedurchführung auch mit 8-poliger M12-Anschluss-technik verfügbar/Feed-through also available with 8-pole M12 connection technology



# T-Stücke für Versorgungskabel, Typ 52

## T-pieces for Power Cables, Type 52

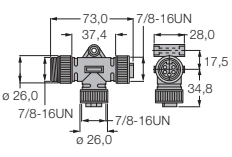
Abmessung Dimensions [mm]	Anwendung Application	Verbindungs- technik Connection  Fig. (Fxxx)	Typenbezeichnung Type	Ident-Nr. Ident-no.
	<p>T-Stück für Versorgung, Nennstrom: 9 A</p> <p>T piece for power Rated current: 9 A</p>	<p>2 x 7/8" (F037) 1 x 7/8" (F052)</p>	<b>RSM-2RKM50</b>	6914950

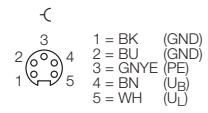
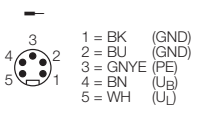
Anschlussbelegung Pin Configuration	( F037 )	( F052 )		
	 <p>           1 = BK (GND)            2 = BU (GND)            3 = GNYE (PE)            4 = BN (U<sub>B</sub>)            5 = WH (U<sub>L</sub>)         </p>	 <p>           1 = BK (GND)            2 = BU (GND)            3 = GNYE (PE)            4 = BN (U<sub>B</sub>)            5 = WH (U<sub>L</sub>)         </p>		

# Konfektionierbare Steckverbinder für Versorgungskabel, Typ 52

## Field wireable Connectors for Power Cables, Type 52

**TURCK**

Industrial  
Automation

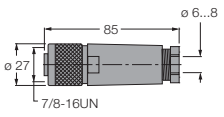
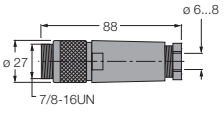
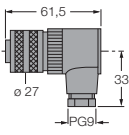
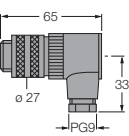
Abmessung Dimensions [mm]	Anwendung Application	Verbindungs- technik Connection Fig. (Fxxx)	Typenbezeichnung Type	Ident-Nr. Ident-no.
	Konfektionierbare 7/8"-Kupplung, Klemmbereich: 6...8 mm Nennstrom: 9 A Field-wireable female 7/8" connector, clamping width: 6...8 mm, Rated current: 9 A	1 x 7/8" (F037)	<b>B4151-0/9</b>	6904717
	Konfektionierbarer 7/8"-Stecker, Klemmbereich: 6...8 mm Nennstrom: 9 A Field-wireable male 7/8" connector, clamping width: 6...8 mm, Rated current: 9 A	1 x 7/8" (F052)	<b>BS4151-0/9</b>	6904718
	Konfektionierbare 7/8"-Kupplung, Klemmbereich: 6...8 mm, Nennstrom: 9 A Field-wireable female 7/8" connector, clamping width: 6...8 mm, Rated current: 9 A	1 x 7/8" (F037)	<b>B4251-0/9</b>	6901113
	Konfektionierbarer 7/8"-Stecker, Klemmbereich: 6...8 mm, Nennstrom: 9 A Field-wireable male 7/8" connector, clamping width: 6...8 mm, Rated current: 9 A	1 x 7/8" (F052)	<b>BS4251-0/9</b>	6901112

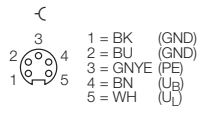
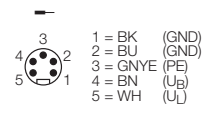
Anschlussbelegung Pin Configuration	( F037 )	( F052 )		
				

A4

# Durchführungen/Flansche für Versorgungskabel, Typ 52

## Feed-through Recept./Flange Connect. for Power Cables, Type 52



Abmessung Dimensions [mm]	Anwendung Application	Verbindungs- technik Connection  Fig. (Fxxx)	Typenbezeichnung Type	Ident-Nr. Ident-no.
	<p>7/8"-Durchführung, Stecker, Kupplung, Lochmaß 22,5 mm, Nennstrom: 9 A 7/8" feed-through connection, male, female, hole diameter 22.5 mm, Rated current: 9 A</p>	<p>1 x 7/8" (F052) 1 x 7/8" (F037)</p>	<b>RSF-RKF-57/22</b>	6602218
	<p>Lötbarer 7/8"-Flanschstecker, Nennstrom: 9 A Solderable male 7/8" flange connector, Rated current: 9 A</p>	1 x 7/8" (F052)	<b>RSF57</b>	6602342
	<p>Lötbare 7/8"-Flanschkupplung, Nennstrom: 9 A Solderable female 7/8" flange connector, Rated current: 9 A</p>	1 x 7/8" (F037)	<b>RKF57</b>	6602217
	<p>1/2"-Gegenmutter für NPT-Gewinde 1/2" locknut for NPT thread</p>	–	<b>LN1/2-14NPT/10</b>	6961002
	<p>1/2"-Gegenmutter für G-Gewinde, 100 Stck. 1/2" locknut for G thread, 100 pieces</p>	–	<b>Locknut G1/2"</b>	6900493

Anschlussbelegung Pin Configuration	( F037 )	( F052 )		
	<p>1 = BK (GND) 2 = BU (GND) 3 = GNYE (PE) 4 = BN (U<sub>B</sub>) 5 = WH (U<sub>L</sub>)</p>	<p>1 = BK (GND) 2 = BU (GND) 3 = GNYE (PE) 4 = BN (U<sub>B</sub>) 5 = WH (U<sub>L</sub>)</p>		

# T-Stücke für Versorgungskabel, Typ 43

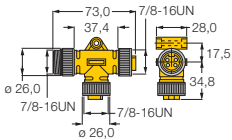
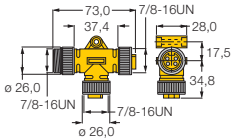
## T-pieces for Power Cables, Type 43

Abmessung Dimensions [mm]	Anwendung Application	Verbindungs- technik Connection Fig. (Fxxx)	Typenbezeichnung Type	Ident-Nr. Ident-no.
	<p>T-Stück für Auxiliary-Power, Nennstrom: 9 A</p> <p>T piece for auxiliary power, Rated current: 9 A</p>	<p>1 x 7/8" (F015) 2 x 7/8" (F097)</p>	<b>RSM-2RKM40</b>	6914828
	<p>T-Stück für Auxiliary-Power, (Keyway facing female), Nennstrom: 9 A</p> <p>T piece for auxiliary power, (keyway facing female), Rated current: 9 A</p>	<p>1 x 7/8" (F015) 2 x 7/8" (F097)</p>	<b>RKM40-RKM40-L-RSM40</b>	6914866



Anschlussbelegung Pin Configuration	( F015 )	( F097 )		
	 <p>1 = RD (Aux +) 2 = GN (E +) 3 = WH (E -) 4 = BK (Aux -)</p>	 <p>1 = RD (Aux +) 2 = GN (E +) 3 = WH (E -) 4 = BK (Aux -)</p>		

# Konfektionierbare Steckverbinder für Versorgungskabel, Typ 43

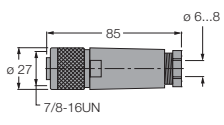
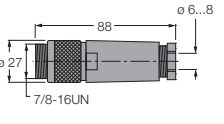
## Field wireable Connectors for Power Cables, Type 43

Abmessung Dimensions [mm]	Anwendung Application	Verbindungs- technik Connection Fig. (Fxxx)	Typenbezeichnung Type	Ident-Nr. Ident-no.
	<p>Konfektionierbare 7/8"-Kupplung, Klemmbereich: 6...8 mm, Nennstrom: 9 A Field-wireable female 7/8" connector, clamping width: 6...8 mm, Rated current: 9 A</p>	1 x 7/8" (F097)	<b>B4148-0/9</b>	6914925
	<p>Konfektionierbarer 7/8"-Stecker, Klemmbereich: 6...8 mm, Nennstrom: 9 A Field-wireable male 7/8" connector, clamping width: 6...8 mm, Rated current: 9 A</p>	1 x 7/8" (F015)	<b>BS4148-0/9</b>	6914522

### Anschlussbelegung Pin Configuration

	( F015 )	( F097 )		
	 <p>1 = RD (Aux +) 2 = GN (E +) 3 = WH (E -) 4 = BK (Aux -)</p>	 <p>1 = RD (Aux +) 2 = GN (E +) 3 = WH (E -) 4 = BK (Aux -)</p>		



# Durchführungen/Flansche für Versorgungskabel, Typ 43 Feed-through Recept./Flanged connect. for Power cables, Type 43

Abmessung Dimensions [mm]	Anwendung Application	Verbindungs- technik Connection Fig. (Fxxx)	Typenbezeichnung Type	Ident-Nr. Ident-no.
	<p>7/8"-Durchführung, Stecker, Kupplung, Lochmaß 22,5 mm, Nennstrom: 9 A 7/8" feed-through connection, male, female, hole diameter 22.5 mm, Rated current: 9 A</p>	<p>1 x 7/8" (F015) 1 x 7/8" (F097)</p>	<b>RSF-RKF-40/22</b>	6915014
	<p>Lötbarer 7/8"-Flanschstecker, Nennstrom: 9 A Solderable male 7/8" flange connector, Rated current: 9 A</p>	1 x 7/8" (F015)	<b>RSFL46</b>	6914836
	<p>Lötbare 7/8"-Flanschkupplung Nennstrom: 9 A Solderable female 7/8" flange connector, Rated current: 9 A</p>	1 x 7/8" (F097)	<b>RKFL46</b>	6915086
	<p>1/2"-Gegenmutter für NPT-Gewinde 1/2" locknut for NPT thread</p>	—	<b>LN1/2-14NPT/10</b>	6961002
	<p>1/2"-Gegenmutter für G-Gewinde, 100 Stck. 1/2" locknut for G thread, 100 pieces</p>	—	<b>Locknut G1/2"</b>	6900493

Anschlussbelegung Pin Configuration	( F015 )	( F097 )		
	<p>—</p>	<p>⌋</p>		

# Steckverbinder-Systeme für Sensoren und Aktuatoren (M8 x 1)

## Connector Systems for Sensors and Actuators (M8 x 1)

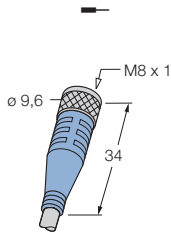
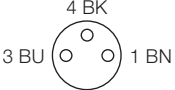
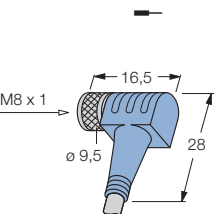
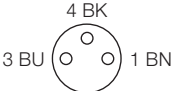
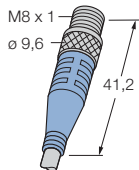
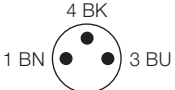
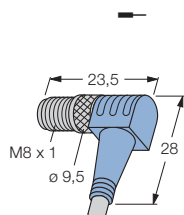
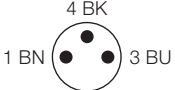
Abmessungen/Bauform Dimensions/Housing style [mm]	Anschluss Pin configuration	Leitung/Cable					
		Querschnitt Cross section [mm <sup>2</sup> ]	Adernaufbau Conductor construction [mm]	Länge Length [m]	Qualität Quality	Farbe Colour	Durchmesser Diameter [mm]
 <p>M8 x 1 ø 9,6 34</p>	<p>M8 x 1</p> 	3 x 0,25	32 x 0,1	2	PUR	GY	4,4
		3 x 0,25	32 x 0,1	5	PUR	GY	4,4
		3 x 0,25	32 x 0,1	10	PUR	GY	4,4
 <p>M8 x 1 ø 9,5 16,5 28</p>	<p>M8 x 1</p> 	3 x 0,25	32 x 0,1	2	PUR	GY	4,4
		3 x 0,25	32 x 0,1	5	PUR	GY	4,4
		3 x 0,25	32 x 0,1	10	PUR	GY	4,4
 <p>M8 x 1 ø 9,6 41,2</p>	<p>M8 x 1</p> 	3 x 0,25	32 x 0,1	2	PUR	GY	4,4
		3 x 0,25	32 x 0,1	5	PUR	GY	4,4
		3 x 0,25	32 x 0,1	10	PUR	GY	4,4
 <p>M8 x 1 ø 9,5 23,5 28</p>	<p>M8 x 1</p> 	3 x 0,25	32 x 0,1	2	PUR	GY	4,4
		3 x 0,25	32 x 0,1	5	PUR	GY	4,4
		3 x 0,25	32 x 0,1	10	PUR	GY	4,4

Typenbezeichnung Type	Ident-Nr. Ident no.	Nennstrom Rated current [A]	Nennspannung Rated voltage [V]	Werkstoff/Material Überwurfmutter Material Coupling nut	Umgebungstemperatur Temperature range [°C]		Schutzart Degree of protection	LED	
					Stecker Connector	Leitung Cable		U <sub>B</sub>	
<b>SKP3-2/S90</b>	8007332	4	max. 60	CuZn-Ni	-30...+90	-40...+80	IP67		
<b>SKP3-5/S90</b>	8007336	4	max. 60	CuZn-Ni	-30...+90	-40...+80	IP67		
<b>SKP3-10/S90</b>	8007340	4	max. 60	CuZn-Ni	-30...+90	-40...+80	IP67		
<b>SWKP3-2/S90</b>	8007368	4	max. 60	CuZn-Ni	-30...+90	-40...+80	IP67		
<b>SWKP3-5/S90</b>	8007372	4	max. 60	CuZn-Ni	-30...+90	-40...+80	IP67		
<b>SWKP3-10/S90</b>	8007376	4	max. 60	CuZn-Ni	-30...+90	-40...+80	IP67		
<b>SSP3-2/S90</b>	8007350	4	max. 60	CuZn-Ni	-30...+90	-40...+80	IP67		
<b>SSP3-5/S90</b>	8007354	4	max. 60	CuZn-Ni	-30...+90	-40...+80	IP67		
<b>SSP3-10/S90</b>	8007358	4	max. 60	CuZn-Ni	-30...+90	-40...+80	IP67		
<b>SWSP3-2/S90</b>	8007386	4	max. 60	CuZn-Ni	-30...+90	-40...+80	IP67		
<b>SWSP3-5/S90</b>	8007390	4	max. 60	CuZn-Ni	-30...+90	-40...+80	IP67		
<b>SWSP3-10/S90</b>	8007394	4	max. 60	CuZn-Ni	-30...+90	-40...+80	IP67		

# Steckverbinder-Systeme für Sensoren und Aktuatoren (M8 x 1)

## Connector Systems for Sensors and Actuators (M8 x 1)

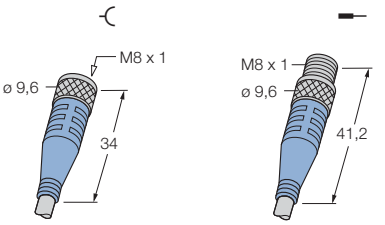
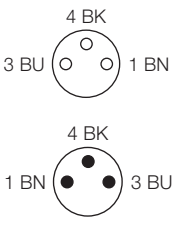
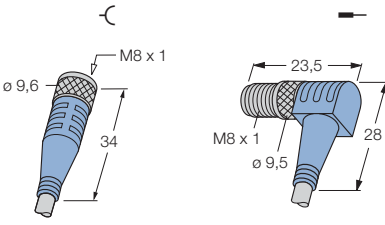
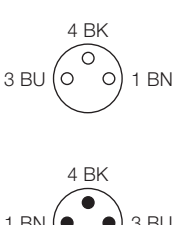
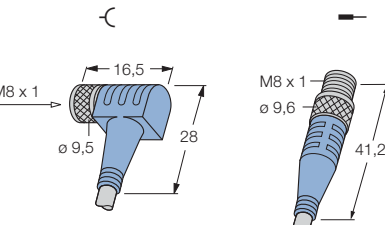
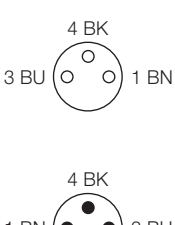
Abmessungen/Bauform Dimensions/Housing style [mm]	Anschluss Pin configuration	Leitung/Cable					
		Querschnitt Cross section [mm <sup>2</sup> ]	Adernaufbau Conductor construction [mm]	Länge Length [m]	Qualität Quality	Farbe Colour	Durchmesser Diameter [mm]
 <p>M8 x 1 - M8 x 1</p>		3 x 0,25	32 x 0,1	1	PUR	GY	4,4
		3 x 0,25	32 x 0,1	1,5	PUR	GY	4,4
		3 x 0,25	32 x 0,1	2	PUR	GY	4,4
		3 x 0,25	32 x 0,1	5	PUR	GY	4,4
 <p>M8 x 1 - M8 x 1</p>		3 x 0,25	32 x 0,1	1	PUR	GY	4,4
		3 x 0,25	32 x 0,1	1,5	PUR	GY	4,4
		3 x 0,25	32 x 0,1	2	PUR	GY	4,4
		3 x 0,25	32 x 0,1	5	PUR	GY	4,4
 <p>M8 x 1 - M8 x 1</p>		3 x 0,25	32 x 0,1	1	PUR	GY	4,4
		3 x 0,25	32 x 0,1	1,5	PUR	GY	4,4
		3 x 0,25	32 x 0,1	2	PUR	GY	4,4
		3 x 0,25	32 x 0,1	5	PUR	GY	4,4

Typenbezeichnung Type	Ident-Nr. Ident no.	Nennstrom Rated current [A]	Nennspannung Rated voltage [V]	Werkstoff/Material Überwurfmutter Material Coupling nut	Umgebungstemperatur Temperature range [°C]		Schutzart Degree of protection	LED	
					Stecker Connector	Leitung Cable		U <sub>B</sub>	⏏
<b>SKP3-1-SSP3/S90</b>	8008683	4	max. 60	CuZn-Ni	-30...+90	-40...+80	IP67		
<b>SKP3-1,5-SSP3/S90</b>	8008690	4	max. 60	CuZn-Ni	-30...+90	-40...+80	IP67		
<b>SKP3-2-SSP3/S90</b>	8008685	4	max. 60	CuZn-Ni	-30...+90	-40...+80	IP67		
<b>SKP3-5-SSP3/S90</b>	8008686	4	max. 60	CuZn-Ni	-30...+90	-40...+80	IP67		
<b>SKP3-1-SWSP3/S90</b>	8015454	4	max. 60	CuZn-Ni	-30...+90	-40...+80	IP67		
<b>SKP3-1,5-SWSP3/S90</b>	8024802	4	max. 60	CuZn-Ni	-30...+90	-40...+80	IP67		
<b>SKP3-2-SWSP3/S90</b>	8015457	4	max. 60	CuZn-Ni	-30...+90	-40...+80	IP67		
<b>SKP3-5-SWSP3/S90</b>	8015460	4	max. 60	CuZn-Ni	-30...+90	-40...+80	IP67		
<b>SWKP3-1-SSP3/S90</b>	8015408	4	max. 60	CuZn-Ni	-30...+90	-40...+80	IP67		
<b>SWKP3-1,5-SSP3/S90</b>	8016217	4	max. 60	CuZn-Ni	-30...+90	-40...+80	IP67		
<b>SWKP3-2-SSP3/S90</b>	8015456	4	max. 60	CuZn-Ni	-30...+90	-40...+80	IP67		
<b>SWKP3-5-SSP3/S90</b>	8015459	4	max. 60	CuZn-Ni	-30...+90	-40...+80	IP67		

# Steckverbinder-Systeme für Sensoren und Aktuatoren (M8 x 1)

## Connector Systems for Sensors and Actuators (M8 x 1)

Abmessungen/Bauform Dimensions/Housing style [mm]	Anschluss Pin configuration	Leitung/Cable					
		Querschnitt Cross section [mm <sup>2</sup> ]	Adernaufbau Conductor construction [mm]	Länge Length [m]	Qualität Quality	Farbe Colour	Durchmesser Diameter [mm]
	<b>M8 x 1- M8 x 1-</b> 	3 x 0,25	32 x 0,1	1	PUR	BK	4,4
		3 x 0,25	32 x 0,1	2	PUR	BK	4,4
		3 x 0,25	32 x 0,1	5	PUR	BK	4,4
	<b>M8 x 1</b> 	4 x 0,25	32 x 0,1	2	PUR	GY	4,4
		4 x 0,25	32 x 0,1	5	PUR	GY	4,4
		4 x 0,25	32 x 0,1	10	PUR	GY	4,4
	<b>M8 x 1</b> 	4 x 0,25	32 x 0,1	2	PUR	GY	4,4
		4 x 0,25	32 x 0,1	5	PUR	GY	4,4
		4 x 0,25	32 x 0,1	10	PUR	GY	4,4
	<b>M12 x 1- M8 x 1</b> 	3 x 0,25	32 x 0,1	1	PUR	BK	4,4
		3 x 0,25	32 x 0,1	2	PUR	BK	4,4
		3 x 0,25	32 x 0,1	5	PUR	BK	4,4
	<b>M12 x 1- M8 x 1</b> 	3 x 0,25	32 x 0,1	1	PUR	BK	4,4
		3 x 0,25	32 x 0,1	2	PUR	BK	4,4
		3 x 0,25	32 x 0,1	5	PUR	BK	4,4
	<b>M12 x 1- M8 x 1</b> 	3 x 0,25	32 x 0,1	1	PUR	BK	4,4
		3 x 0,25	32 x 0,1	2	PUR	BK	4,4
		3 x 0,25	32 x 0,1	5	PUR	BK	4,4

Typenbezeichnung Type	Ident-Nr. Ident no.	Nennstrom Rated current [A]	Nennspannung Rated voltage [V]	Werkstoff/Material Überwurfmutter Material Coupling nut	Umgebungstemperatur Temperature range [°C]		Schutzart Degree of protection	LED	
					Stecker Connector	Leitung Cable		U <sub>B</sub>	┘
<b>SWKP3-1-SWSP3/S90</b>	8015455	4	max. 60	CuZn-Ni	-40...+80	-25...+80	IP67		
<b>SWKP3-2-SWSP3/S90</b>	8015458	4	max. 60	CuZn-Ni	-40...+80	-25...+80	IP67		
<b>SWKP3-5-SWSP3/S90</b>	8015461	4	max. 60	CuZn-Ni	-40...+80	-25...+80	IP67		
<b>SSP4-2/S90</b>	8007362	4	max. 30	CuZn-Ni	-30...+90	-40...+80	IP67		
<b>SSP4-5/S90</b>	8007364	4	max. 30	CuZn-Ni	-30...+90	-40...+80	IP67		
<b>SSP4-10/S90</b>	8007366	4	max. 30	CuZn-Ni	-30...+90	-40...+80	IP67		
<b>SWSP4-2/S90</b>	8007398	4	max. 30	CuZn-Ni	-30...+90	-40...+80	IP67		
<b>SWSP4-5/S90</b>	8007400	4	max. 30	CuZn-Ni	-30...+90	-40...+80	IP67		
<b>SWSP4-10/S90</b>	8007402	4	max. 30	CuZn-Ni	-30...+90	-40...+80	IP67		
<b>WAK3-1-SWSP3/S90</b>	8015463	4	max. 60	CuZn-Ni	-40...+80	-25...+80	IP67		
<b>WAK3-2-SWSP3/S90</b>	8015464	4	max. 60	CuZn-Ni	-40...+80	-25...+80	IP67		
<b>WAK3-5-SWSP3/S90</b>	8015465	4	max. 60	CuZn-Ni	-40...+80	-25...+80	IP67		
<b>WWAK3-1-SSP3/S90</b>	8012996	4	max. 60	CuZn-Ni	-40...+80	-25...+80	IP67		
<b>WWAK3-2-SSP3/S90</b>	8015476	4	max. 60	CuZn-Ni	-40...+80	-25...+80	IP67		
<b>WWAK3-5-SSP3/S90</b>	8015477	4	max. 60	CuZn-Ni	-40...+80	-25...+80	IP67		
<b>WWAK3-1-SWSP3/S90</b>	8015471	4	max. 60	CuZn-Ni	-40...+80	-25...+80	IP67		
<b>WWAK3-2-SWSP3/S90</b>	8015472	4	max. 60	CuZn-Ni	-40...+80	-25...+80	IP67		
<b>WWAK3-5-SWSP3/S90</b>	8015473	4	max. 60	CuZn-Ni	-40...+80	-25...+80	IP67		

# Steckverbinder-Systeme für Sensoren und Aktuatoren (M12 x 1 auf M8 x 1/M12 x 1/Ende offen) Connector Systems for Sensors and Actuators (M12 x 1 to M8 x 1/M12 x 1/Open end)

Abmessungen/Bauform Dimensions/Housing style [mm]	Anschluss Pin configuration	Leitung/Cable					
		Querschnitt Cross section [mm <sup>2</sup> ]	Adernaufbau Conductor construction [mm]	Länge Length [m]	Qualität Quality	Farbe Colour	Durchmesser Diameter [mm]
<p><b>M12 x 1 - M8 x 1</b></p>		3 x 0,25	32 x 0,1	1	PUR	GY	4,4
		3 x 0,25	32 x 0,1	1,5	PUR	GY	4,4
		3 x 0,25	32 x 0,1	2	PUR	GY	4,4
		3 x 0,25	32 x 0,1	5	PUR	GY	4,4
		3 x 0,25	32 x 0,1	10	PUR	GY	4,4
		3 x 0,25	32 x 0,1	10	PUR	GY	4,4
<p><b>M12 x 1</b></p>		4 x 0,34	43 x 0,1	1	PUR	GY	5,2
		4 x 0,34	43 x 0,1	2	PUR	GY	5,2
		4 x 0,34	43 x 0,1	5	PUR	GY	5,2
		4 x 0,34	43 x 0,1	10	PUR	GY	5,2
<p><b>M12 x 1</b></p>		4 x 0,34	43 x 0,1	2	PUR	GY	5,2
		4 x 0,34	43 x 0,1	5	PUR	GY	5,2
		4 x 0,34	43 x 0,1	10	PUR	GY	5,2
<p><b>M12 x 1 - M12 x 1</b></p>		4 x 0,34	43 x 0,1	5	PVC	GY	5,2
		4 x 0,34	43 x 0,1	2	PUR	GY	5,2
		4 x 0,34	43 x 0,1	5	PUR	GY	5,2
		4 x 0,34	43 x 0,1	2	PVC-X	GY	5,2
		4 x 0,34	43 x 0,1	5	PVC-X	GY	5,2
		4 x 0,34	43 x 0,1	5	PVC-X	GY	5,2







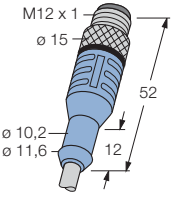
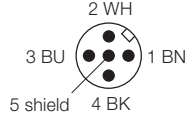
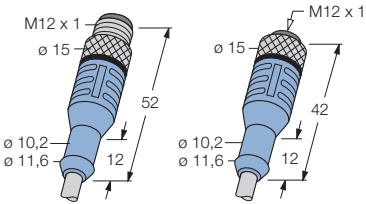
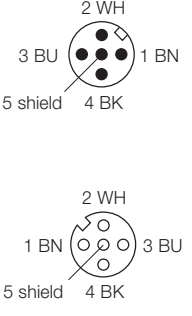



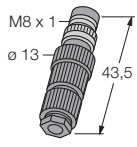

Typenbezeichnung Type	Ident-Nr. Ident no.	Nennstrom Rated current [A]	Nennspannung Rated voltage [V]	Werkstoff/Material Überwurfmutter Material Coupling nut	Umgebungstemperatur Temperature range [°C]		Schutzart Degree of protection	LED	
					Stecker Connector	Leitung Cable		U <sub>B</sub>	┘
<b>WAK3-1-SSP3/S90</b>	8009713	4	max. 60	CuZn-Ni	-30...+90	-40...+80	IP67		
<b>WAK3-1,5-SSP3/S90</b>	8017210	4	max. 60	CuZn-Ni	-30...+90	-40...+80	IP67		
<b>WAK3-2-SSP3/S90</b>	8010511	4	max. 60	CuZn-Ni	-30...+90	-40...+80	IP67		
<b>WAK3-5-SSP3/S90</b>	8015475	4	max. 60	CuZn-Ni	-30...+90	-40...+80	IP67		
<b>WAK3-10-SSP3/S90</b>	8028770	4	max. 60	CuZn-Ni	-30...+90	-40...+80	IP67		
<b>WAS4-1/S90</b>	8006968	4	max. 250	CuZn-Ni	-40...+80	-25...+80	IP67		
<b>WAS4-2/S90</b>	8007098	4	max. 250	CuZn-Ni	-40...+80	-25...+80	IP67		
<b>WAS4-5/S90</b>	8007105	4	max. 250	CuZn-Ni	-40...+80	-25...+80	IP67		
<b>WAS4-10/S90</b>	8007112	4	max. 250	CuZn-Ni	-40...+80	-25...+80	IP67		
<b>WWAS4-2/S90</b>	8007200	4	max. 250	CuZn-Ni	-40...+80	-25...+80	IP67		
<b>WWAS4-5/S90</b>	8007207	4	max. 250	CuZn-Ni	-40...+80	-25...+80	IP67		
<b>WWAS4-10/S90</b>	8007214	4	max. 250	CuZn-Ni	-40...+80	-25...+80	IP67		
<b>WAK4-5-WAS4/P00</b>	8006745	4	max. 250	CuZn-Ni	-40...+80	-25...+80	IP67		
<b>WAK4-2-WAS4/S90</b>	8006739	4	max. 250	CuZn-Ni	-40...+80	-25...+80	IP67		
<b>WAK4-5-WAS4/S90</b>	8006746	4	max. 250	CuZn-Ni	-40...+80	-25...+80	IP67		
<b>WAK4-2-WAS4/XOR</b>	8006740	4	max. 250	CuZn-Ni	-40...+80	-25...+80	IP67		
<b>WAK4-5-WAS4/XOR</b>	8006747	4	max. 250	CuZn-Ni	-40...+80	-25...+80	IP67		

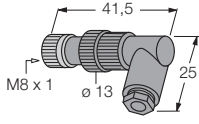
# Steckverbinder-Systeme für Sensoren und Aktuatoren (M12 x 1) – geschirmt Connector Systems for Sensors and Actuators (M12 x 1) – shielded

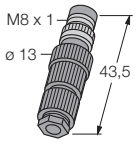

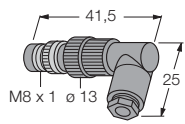

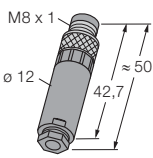

Abmessungen/Bauform Dimensions/Housing style [mm]	Anschluss Pin configuration	Leitung/Cable							
		Querschnitt Cross section [mm <sup>2</sup> ]	Adernaufbau Conductor construction [mm]	Länge Length [m]	Qualität Quality	Farbe Colour	Durchmesser Diameter [mm]	Halogenfrei Halogen free	
 <p><b>M12 x 1</b></p>		5 x 0,34	43 x 0,1	2	PUR	GY	5,2	•	
		5 x 0,34	43 x 0,1	5	PUR	GY	5,2	•	
		5 x 0,34	43 x 0,1	10	PUR	GY	5,2	•	
 <p><b>M12 x 1- M12 x 1</b></p>		5 x 0,34	43 x 0,1	1	PUR	GY	5,2	•	
		5 x 0,34	43 x 0,1	2	PUR	GY	5,2	•	
		5 x 0,34	43 x 0,1	5	PUR	GY	5,2	•	
		5 x 0,34	43 x 0,1	20	PUR	GY	5,2	•	

Typenbezeichnung Type	Ident-Nr. Ident no.	Nennstrom Rated current [A]	Nennspannung Rated voltage [VAC/VDC]	Werkstoff/Material Überwurfmutter Material Coupling nut	Umgebungstemperatur Temperature range [°C]		Schutzart Degree of protection	LED	
					Stecker Connector	Leitung Cable		U <sub>B</sub>	⏏
<b>WAS4.5-2/S57</b>	8016985	4	30/36		-40...+80	-40...+90	IP67		
<b>WAS4.5-5/S57</b>	8016986	4	30/36		-40...+80	-40...+90	IP67		
<b>WAS4.5-10/S57</b>	8024442	4	30/36		-40...+80	-40...+90	IP67		
<b>WAK4.5-1-WAS4.5/S57</b>	8016987	4	30/36	CuZn-Ni	-40...+80	-40...+90	IP67		
<b>WAK4.5-2-WAS4.5/S57</b>	8016988	4	30/36	CuZn-Ni	-40...+80	-40...+90	IP67		
<b>WAK4.5-5-WAS4.5/S57</b>	8016989	4	30/36	CuZn-Ni	-40...+80	-40...+90	IP67		
<b>WAK4.5-20-WAS4.5/S57</b>	8033558	4	30/36	CuZn-Ni	-40...+80	-40...+90	IP67		

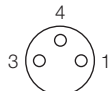
# Konfektionierbare Steckverbinder-Systeme (M8 x 1) Field wireable Connector Systems (M8 x 1)

Abmessungen/Bauform Dimensions/Housing style  [mm]	Leiteranzahl Number of conductors	Anschluss- technik <sup>1)</sup> Connection technology <sup>1)</sup>  [m]	Werkstoffe/Materials			
			Kontaktträger Contact carrier	Überwurfmutter Coupling nut	Griffteil Grip	
 M8 x 1 ø 13 43,5	<b>M8 x 1</b> 	3	E	PA	CuZn-Ni	PA
		4	E	PA	CuZn-Ni	PA
		3	L	PA	CuZn-Ni	PBT
		4	L	PA	CuZn-Ni	PBT
		3	S	PA	CuZn-Ni	PBT
		4	S	PA	CuZn-Ni	PBT
 M8 x 1 ø 13 41,5 25	<b>M8 x 1</b> 	3	E	PA	GD-Zn-Ni	PA
		4	E	PA	GD-Zn-Ni	PA
		3	L	PA	CuZn-Ni	PBT
		4	L	PA	CuZn-Ni	PBT
 M8 x 1 ø 13 43,5	<b>M8 x 1</b> 	3	E	PA	CuZn-Ni	PA
		4	E	PA	CuZn-Ni	PA
		3	L	PA	CuZn-Ni	PBT
		4	L	PA	CuZn-Ni	PBT
		3	S	PA	CuZn-Ni	PBT
		4	S	PA	CuZn-Ni	PBT
 M8 x 1 ø 13 41,5 25	<b>M8 x 1</b> 	3	E	PA	GD-Zn-Ni	PA
		4	E	PA	GD-Zn-Ni	PA
		3	L	PA	CuZn-Ni	PBT
		4	L	PA	CuZn-Ni	PBT
 M8 x 1 ø 12 ≈ 50 42,7	<b>M8 x 1</b> 	3	S	PA	GD-Zn-Ni	PA

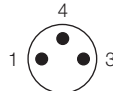





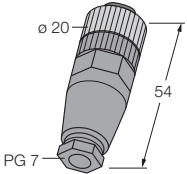

## Anschlussbelegung Pin Configuration

(C015)	(C016)	(C017)	(C018)
 	 	 	 

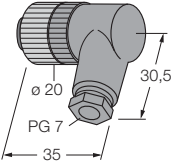

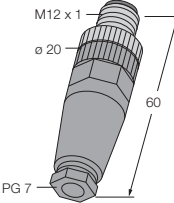

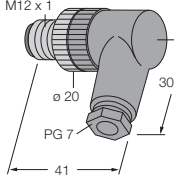

<sup>1)</sup> E = Eindringtechnik/pin penetration technology; L = Löttechnik/soldering technology; S = Schraubtechnik/screw technology

Typenbezeichnung Type	Ident-Nr. Ident no.	Nennstrom Rated current [A]	Nennspannung Rated voltage [VAC/VDC]	Anschluss Connection	max. Kabelquerschnitt max. cable diameter [mm <sup>2</sup> ]	Klemmbereich clamping range [mm]	Umgebungstemperatur/ Temperature range [°C]		Schutzart Degree of protection
							Stecker Connector	Leitung Cable	
<b>HA5131-0</b>	6905404	4	32/32	( C015 )	0,34	3,2...5,4	-25...+85	-	IP67
<b>HA5141-0</b>	6905405	4	32/32	( C016 )	0,34	3,2...5,4	-25...+85	-	IP67
<b>B5131-0</b>	6904910	4	60/60	( C015 )	0,25	4...5	-25...+85	-	IP67
<b>B5141-0</b>	6904915	4	60/60	( C016 )	0,25	4...5	-25...+85	-	IP67
<b>B5133-0</b>	6901030	4	60/60	( C015 )	0,25	4...5	-40...+80	-	IP67
<b>B5143-0</b>	6901031	4	60/60	( C016 )	0,25	4...5	-40...+80	-	IP67
<b>H5231-0</b>	6902800	4	60/60	( C015 )	0,25	4...5	-40...+80	-	IP67
<b>H5241-0</b>	6902820	4	60/60	( C016 )	0,25	4...5	-40...+80	-	IP67
<b>B5231-0</b>	6904810	4	60/60	( C015 )	0,25?	4...5	-40...+85	-	IP67
<b>B5241-0</b>	6904815	4	60/60	( C016 )	0,25	4...5	-40...+85	-	IP67
<b>HAS5131-0</b>	6905402	4	32/32	( C017 )	0,34	3,2...5,4	-25...+85	-	IP67
<b>HAS5141-0</b>	6905403	4	32/32	( C018 )	0,34	3,2...5,4	-25...+85	-	IP67
<b>BS5131-0</b>	6901010	4	60/60	( C017 )	0,34	4...5	-40...+80	-	IP67
<b>BS5141-0</b>	6901011	4	60/60	( C018 )	0,25	4...5	-40...+80	-	IP67
<b>BS5133-0</b>	6901012	4	60/60	( C017 )	0,34	4...5	-40...+80	-	IP67
<b>BS5143-0</b>	6901013	4	60/60	( C018 )	0,25	4...5	-40...+80	-	IP67
<b>HS5231-0</b>	6902810	4	60/60	( C017 )	0,34	4...5	-40...+80	-	IP67
<b>HS5241-0</b>	6902830	4	60/60	( C018 )	0,25	4...5	-40...+80	-	IP67
<b>BS5231-0</b>	6901110	4	60/60	( C017 )	0,34	4...5	-40...+85	-	IP67
<b>BS5241-0</b>	6901111	4	60/60	( C018 )	0,25	4...5	-40...+85	-	IP67
<b>SSPC 3K</b>	8004831	4	60/75	( C018 )	0,5	3...5	-40...+80	-	IP67

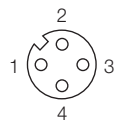
# Konfektionierbare Steckverbinder-Systeme (M12 x 1) Field wireable Connector Systems (M12 x 1)

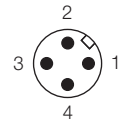
Abmessungen/Bauform Dimensions/Housing style  [mm]	Leiteranzahl Number of conductors	Anschluss- technik <sup>1)</sup> Connection technology <sup>1)</sup>	Werkstoffe/Materials		
			Kontaktträger Contact carrier	Überwurfmutter Coupling nut	Griffteil Grip
 <b>M12 x 1</b> 	4	E	PA	CuZn-Ni	PA
	5	S	PBT	CuZn-Ni	PBT
	8	S	PA	PA	PA
 <b>M12 x 1</b> 	4	E	PA	CuZn-Ni	PA
	5	S	PA	PA	PA
 <b>M12 x 1</b> 	4	E	PA	CuZn-Ni	PA
	5	S	PA	CuZn-Ni	PA
	8	S	PA	CuZn-Ni	PA
 <b>M12 x 1</b> 	4	E	PA	CuZn-Ni	PA
	5	S	PA	PA	PA

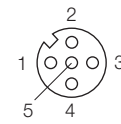
## Anschlussbelegung Pin Configuration

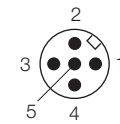
( C011 )	( C012 )	( C020 )	( C021 )
 	 	 	 

<sup>1)</sup> E = Eindringtechnik/pin penetration technology; S = Schraubtechnik/screw technology

Typenbezeichnung Type	Ident-Nr. Ident no.	Nennstrom Rated current [A]	Nennspannung Rated voltage [VAC/VDC]	Anschluss Connection	max. Kabelquerschnitt max. cable diameter [mm <sup>2</sup> ]	Klemmbereich clamping range [mm]	Umgebungstemperatur/ Temperature range [°C]		Schutzart Degree of protection
							Stecker Connector	Leitung Cable	
<b>HA8141-0</b>	6905407	4	32/32	( C011 )	0,34	4...5,1	-25...+85	-	IP67
<b>B8151-0</b>	6904601	4	30/36	( C020 )	0,75	3...6,5	-40...+80	-	IP67
<b>B8181-0</b>	6904605	4	60/60	( C033 )	0,75	4...6	-40... +85	-	
<b>HA8241-0</b>	6905401	4	32/32	( C011 )	0,34	4...5,1	-25...+85	-	IP67
<b>B8251-0</b>	6904602	4	125/125	( C020 )	0,75	3...6,5	-25...+85	-	IP67
<b>HAS8141-0</b>	6905406	4	32/32	( C012 )	0,34	4...5,1	-25...+85	-	IP67
<b>BS8151-0</b>	6904611	4	125/150	( C021 )	0,75	3...6,5	-40...+85	-	IP67
<b>BS8181-0</b>	6901004	4	60/60	( C034 )	0,5	6...8	-40... +85	-	
<b>HAS8241-0</b>	6905400	4	32/32	( C012 )	0,34	4...5,1	-25...+85	-	IP67
<b>BS8251-0</b>	6904612	4	125/150	( C021 )	0,75	3...6,5	-40...+85	-	IP67

**Anschlussbelegung  
Pin Configuration**

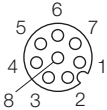
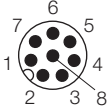
( C033 )	( C034 )		
			

**A5**

# Konfektionierbare Steckverbinder-Systeme (M12 x 1) – geschirmt Field wireable Connector Systems (M12 x 1) – shielded

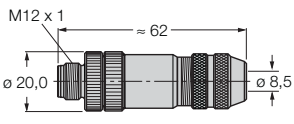
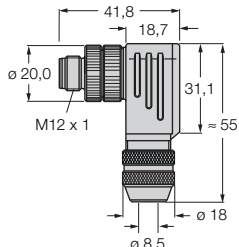
Abmessungen/Bauform Dimensions/Housing style  [mm]	Leiteranzahl Number of conductors	Anschluss- technik <sup>1)</sup> Connection technology <sup>1)</sup>	Werkstoffe/Materials		
			Kontaktträger Contact carrier	Überwurfmutter Coupling nut	Griffteil Grip
 <p><b>M12 x 1</b></p>	5	S	PBT	CuZn-Ni	PBT
 <p><b>M12 x 1</b></p>	5	S	PBT	CuZn-Ni	PBT

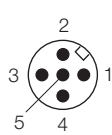
Anschlussbelegung Pin Configuration	( C021 )		
			

<sup>1)</sup> S = Schraubtechnik/screw technology



Typenbezeichnung Type	Ident-Nr. Ident no.	Nennstrom Rated current [A]	Nennspannung Rated voltage [VAC/VDC]	Anschluss Connection	max. Kabelquerschnitt max. cable diameter [mm <sup>2</sup> ]	Klemmbereich clamping range [mm]	Umgebungstemperatur/ Temperature range [°C]		Schutzart Degree of protection
							Stecker Connector	Leitung Cable	
<b>CMBS8151-0</b>	6930161	4	125/150	( C021 )	0,75	6...8	-40...+85	-	IP67
<b>CMBS8251-0</b>	6930216	4	125/150	( C021 )	0,75	6...8	-40...+85	-	IP67

# Konfektionierbare Steckverbinder-Systeme (M23 x 1) Field wireable Connector Systems (M23 x 1)

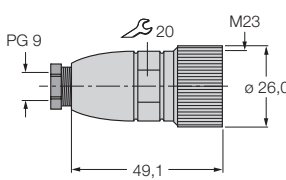
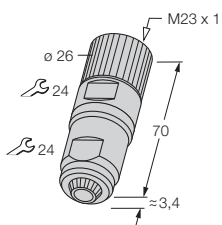
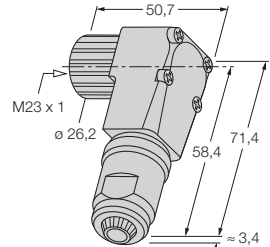
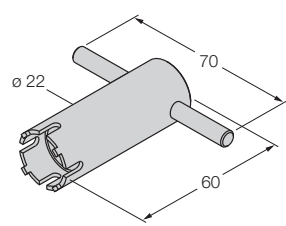
Abmessungen/Bauform Dimensions/Housing style  [mm]	Leiteranzahl Number of conductors	Anschluss- technik <sup>1)</sup> Connection technology <sup>1)</sup>	Werkstoffe/Materials		
			Kontaktträger Contact carrier	Überwurfmutter Coupling nut	Griffteil Grip
 <b>M23 x 1</b>	12	L	PBT	CuZn-Ni	CuZn-Ni
	19	L	PBT	CuZn-Ni	CuZn-Ni
	12	CP	PBT	CuZn-Ni	CuZn-Ni
	19	CP	PBT	CuZn-Ni	CuZn-Ni
 <b>M23 x 1</b>	17	CP	PBT	CuZn-Ni	CuZn-Ni
	17	CP	PBT	CuZn-Ni	CuZn-Ni
 <b>M23 x 1</b>	17	CP	PBT	CuZn-Ni	CuZn-Ni
	17	CP	PBT	CuZn-Ni	CuZn-Ni
 <b>Montagewerkzeug für M23-Steckver- binder/ Mounting tool for M23 connectors</b>					

## Anschlussbelegung Pin Configuration

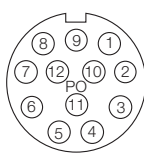
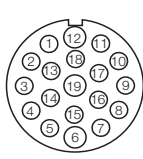
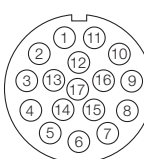
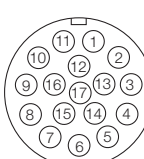
( C028 )	( C073 )	( C074 )	( C075 )
			

<sup>1)</sup> L = Löttechnik/Soldering technology, CP = Crimptechnik/Crimp technology

Typenbezeichnung Type	Ident-Nr. Ident no.	Nennstrom Rated current [A]	Nennspannung Rated voltage [VAC]	Anschluss Connection	max. Kabelquerschnitt max. cable diameter [mm <sup>2</sup> ]	Klemmbereich clamping range [mm]	Umgebungstemperatur/ Temperature range [°C]		Schutzart Degree of protection
							Stecker Connector	Leitung Cable	
<b>FW-M23ST12Q-G-LT-ME-XX-10</b>	6604070	7,5	125	( C028 )	1	4...8	-30...+115	–	IP67
<b>FW-M23ST19Q-G-LT-ME-XX-10</b>	6604208	4/8	125	( C073 )	1	4...8	-30...+115	–	IP67
<b>FW-M23ST12Q-G-CP-ME-XX-10</b>	6604093	7,5	125	( C028 )	1	4...8	-30...+115	–	IP67
<b>FW-M23ST19Q-G-CP-ME-XX-10</b>	6604051	4/8	125	( C073 )	1	4...8	-30...+115	–	IP67
<b>FW-M23ST17Q-G-CP-ME-SH-14.5</b>	6604067	9	125	( C074 )	1	...14,5	-40...+125	–	IP67
<b>FW-M23KU17Q-G-CP-ME-SH-14.5</b>	6604069	9	125	( C075 )	1	...14,5	-40...+125	–	IP67
<b>FW-M23ST17Q-W-CP-ME-SH-14.5</b>	6604068	9	125	( C074 )	1	...14,5	-40...+125	–	IP67
<b>FW-M23KU17Q-W-CP-ME-SH-14.5</b>	6604066	9	125	( C075 )	1	...14,5	-40...+125	–	IP67
<b>RC-Z2099</b>	6900233								

# Verteilersysteme – Aktuator-Sensor-Boxen/E/A-Y-Verteiler Junctions – Actuator-Sensor-Boxes/E/A-Y-Junctions

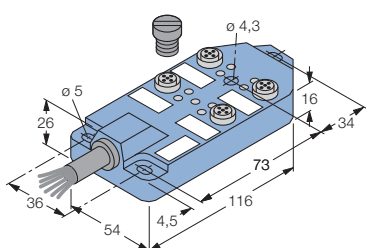
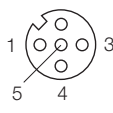
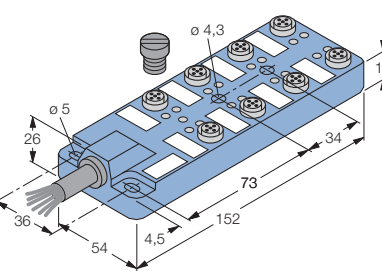
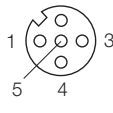
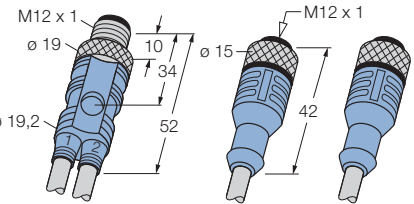
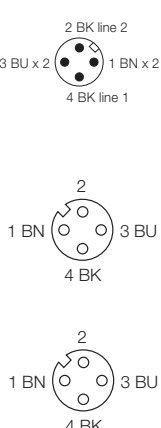
Abmessungen/Bauform Dimensions/Housing style  [mm]	Anschluss Pin configuration	Leitung/Cable					
		Querschnitt Cross section  [mm <sup>2</sup> ]	Adernaufbau Conductor construction  [mm]	Länge Length  [mm]	Qualität <sup>1)</sup> Quality <sup>1)</sup>	Farbe Colour	Durchmesser Diameter  [mm]
		4 x 0,34	43 x 0,1	2	PUR-H	BK	7,5
		3 x 1,0	128 x 0,1				
		8 x 0,34	43 x 0,1	5	PUR-H	BK	8,2
		3 x 1,0	128 x 0,1				
<p><b>M12 x 1 – M12 x 1</b></p> 		4 x 0,34	43 x 0,1	0,3/0,3	PVC	GY	5,2
		4 x 0,34	43 x 0,1	0,6/0,6	PVC	GY	5,2
		4 x 0,34	43 x 0,1	1/1	PVC	GY	5,2
		4 x 0,34	43 x 0,1	0,3/0,3	PUR	GY	5,2
		4 x 0,34	43 x 0,1	0,6/0,6	PUR	GY	5,2
		4 x 0,34	43 x 0,1	1/1	PUR	GY	5,2
		4 x 0,34	43 x 0,1	0,3/0,3	PVC-I	OR	5,2
		4 x 0,34	43 x 0,1	0,6/0,6	PVC-I	OR	5,2
		4 x 0,34	43 x 0,1	1/1	PVC-I	OR	5,2
		4 x 0,34	43 x 0,1	1/1	PVC-I	OR	5,2

1) PUR-H = Polyurethan, halogenfrei/Polyurethane, halogen-free

Typenbezeichnung Type	Ident-Nr. Ident no.	Anschluss Sensoren/ Aktuatoren Connection sensors/ actuators	Nennstrom Rated current  [A]	Nenn- spannung Rated voltage  [V]	Umgebungstemperatur Temperature range [°C]		LEDs
					Verteiler Junction	Leitung Cable	
<b>MB-4M12-5.4P2-2/S366</b>	8024425	M12 x 1	2 / $\Sigma$ 9	max. 30	-30...+ 90	-30...+ 90	5
<b>MB-8M12-5.4P2-5/S366</b>	8024420	M12 x 1	2 / $\Sigma$ 9	max. 30	-30...+ 90	-30...+ 90	9
<b>FSM4-2WAK3-0,3/0,3/P00</b>	8008065	M12 x 1	4	max. 250	-30...+ 90	-40...+ 80	
<b>FSM4-2WAK3-0,6/0,6/P00</b>	8008070	M12 x 1	4	max. 250	-30...+ 90	-40...+ 80	
<b>FSM4-2WAK3-1/1/P00</b>	8009560	M12 x 1	4	max. 250	-30...+ 90	-40...+ 80	
<b>FSM4-2WAK3-0,3/0,3/S90</b>	8008066	M12 x 1	4	max. 250	-30...+ 90	-40...+ 80	
<b>FSM4-2WAK3-0,6/0,6/S90</b>	8008071	M12 x 1	4	max. 250	-30...+ 90	-40...+ 80	
<b>FSM4-2WAK3-1/1/S90</b>	8009561	M12 x 1	4	max. 250	-30...+ 90	-40...+ 80	
<b>FSM4-2WAK3-0,3/0,3/XOR</b>	8008067	M12 x 1	4	max. 250	-30...+ 90	-40...+ 80	
<b>FSM4-2WAK3-0,6/0,6/XOR</b>	8008072	M12 x 1	4	max. 250	-30...+ 90	-40...+ 80	
<b>FSM4-2WAK3-1/1/XOR</b>	8009562	M12 x 1	4	max. 250	-30...+ 90	-40...+ 80	

# Verteilersysteme – Blockverteiler/E/A-Y-Verteiler Junctions – Block Junctions/E/A-Y-Junctions

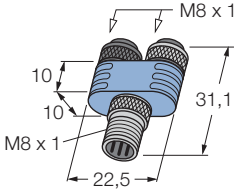
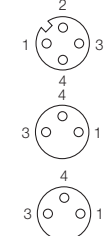
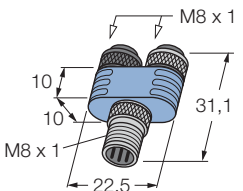
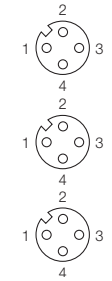
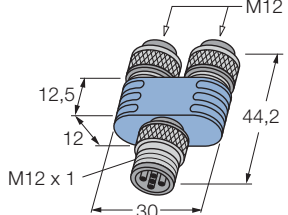
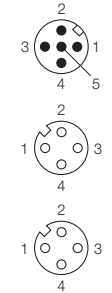
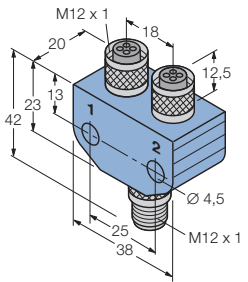
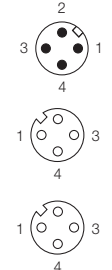
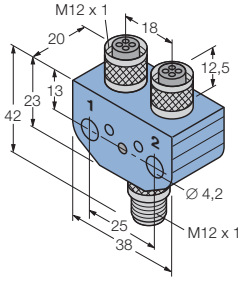
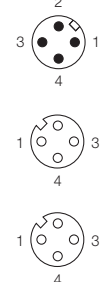
Abmessungen/Bauform Dimensions/Housing style [mm]	Anschluss Pin configuration	Leitung/Cable					
		Querschnitt Cross section [mm <sup>2</sup> ]	Adernaufbau Conductor construction [mm]	Länge Length [mm]	Qualität Quality	Farbe Colour	Durchmesser Diameter [mm]
 <p><b>M8 x 1 – M8 x 1</b></p>		-	-	-	-	-	-
 <p><b>M8 x 1 – M8 x 1</b></p>		-	-	-	-	-	-
 <p><b>M12 x 1 – M12 x 1</b></p>		-	-	-	-	-	-
 <p><b>M12 x 1 – M12 x 1</b></p>		-	-	-	-	-	-
 <p><b>M12 x 1 – M12 x 1</b></p>		-	-	-	-	-	-

1) Gleichzeitiger Anschluss von zwei konfektionierbaren Steckverbindern nicht möglich/  
Simultaneous connection of two field wireable connectors not possible

Typenbezeichnung Type	Ident-Nr. Ident no.	Anschluss Sensoren/ Aktuatoren Connection sensors/ actuators	Nennstrom Rated current  [A]	Nenn- spannung Rated voltage  [V]	Umgebungstemperatur Temperature range [°C]		LED	
					Verteiler Junction	Leitung Cable	U <sub>B</sub>	┘
<b>MB-SSP4-2SKP3<sup>2)</sup></b>	8025693	M8 x 1	2	max. 32	-30...+ 80	-	-	-
<b>MB-SSP4-2SKP4-S2133<sup>2)</sup></b>	8030478	M8 x 1	2	max. 32	-30...+ 80	-	-	-
<b>MB-SSP4-2SKP4P3-S2133<sup>2)</sup></b>	8030477	M8 x 1	2	max. 32	-30...+ 80	-	1	2
<b>FSM5-2FKM5.4/S55<sup>1)</sup></b>	8018720	M12 x 1	4	max. 60	-30...+ 90	-	-	-
<b>FSM5-2FKM5.4/S55/S1874<sup>1,2)</sup></b>	8021378	M12 x 1	4	max. 60	-30...+ 90	-	-	-
<b>FSM5-2FKM5.4/S55/S2292<sup>1)</sup></b>	8033228	M12 x 1	4	max. 60	-30...+ 90	-	-	-
<b>FSM4-2FKM3/S89</b>	8010464	M12 x 1	4	max. 250	-30...+ 90	-	-	-
<b>FSM4-2FKM3P3/S89</b>	8012652	M12 x 1	4	max. 30	-30...+ 90	-	-	3

<sup>2)</sup> Für BL67-M12-Basismodule geeignet/Suitable for BL67 M12-base modules

# Verschlußkappen 7/8" und M12 x 1 7/8" and M12 x 1 blanking plugs

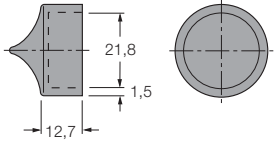
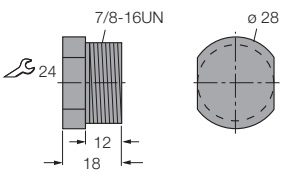
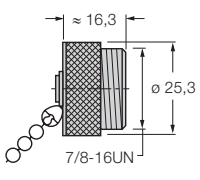
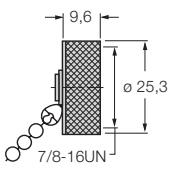
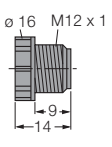
Abmessungen Dimensions	Anwendung Application	Material und Farbe Material and colour	Typenbezeichnung Type	Ident-Nr. Ident no.
	<p>Staubkappe für 7/8"-Einbauflansche, keine interne Verdrahtung, 50 Stück pro Beutel Protective dust cap for 7/8" mounting flange, no internal wiring, 50 pcs. per package</p>	<p>Polyamid schwarz Polyamide black</p>	<b>RSM-DUST-CAP</b>	6914862
	<p>Verschraubkappe für 7/8"-Kupplungen, keine interne Verdrahtung Screw cap for 7/8" female connectors, no internal wiring</p>	<p>Polyamid schwarz Polyamide black</p>	<b>VZ 8</b>	8018816
	<p>Verschraubkappe für 7/8"-Kupplungen, keine interne Verdrahtung, 150 mm Kette Screw cap for 7/8" female connectors, no internal wiring, chain 150 mm</p>	<p>nickelbeschichtetes Messing, schwarz nickel-plated brass black</p>	<b>RSM-CC</b>	6914829
	<p>Verschraubkappe für 7/8"-Stecker, keine interne Verdrahtung, 150 mm Kette Screw cap for 7/8" male connectors, no internal wiring, chain 150 mm</p>	<p>nickelbeschichtetes Messing, schwarz nickel-plated brass black</p>	<b>RKM-CC</b>	6914831
	<p>Verschraubkappe für M12 x 1- Kupplungen, keine interne Verdrahtung Screw cap for M12 x 1 female connectors, no internal wiring</p>	<p>Polyurethan schwarz Polyurethane black</p>	<b>VZ 3</b>	800004

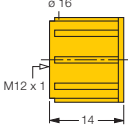
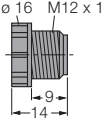

## Verschlusskappen M12 x 1 M12 x 1 blanking plugs

Abmessungen Dimensions	Anwendung Application	Material und Farbe Material and colour	Typenbezeichnung Type	Ident-Nr. Ident no.
	<p>Verschraubkappen für M12 x 1-Stecker (100 Stück pro Beutel) Screw cap for M12 x 1 male connectors (100 pieces per bag)</p>	<p>Polyutethan gelb Polyutethane yellow</p>	<b>VK-M12</b>	6999025
	<p>Verschraubkappen für M12 x 1-Kupplungen (100 Stück pro Beutel) Screw cap for M12 x 1 female connectors (100 pieces per bag)</p>	<p>Polyutethan schwarz Polyutethane black</p>	<b>VS-M12</b>	6999003

## Verschlusskappen M8 x 1 M8 x 1 blanking plugs

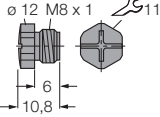
Abmessungen Dimensions	Anwendung Application	Material und Farbe Material and colour	Typenbezeichnung Type	Ident-Nr. Ident no.
	<p>Verschraubkappen für M8 x 1-Kupplungen Screw cap for M8 x 1 female connectors</p>	<p>Nylon schwarz Nylon black</p>	<b>ISK-M8</b>	8015075

# Type index

Type	Page	Type	Page	Type	Page
43	A1 – 4	BL20-2DO-24VDC-2A-P	400	BL20-PKZM0-XRM12	444
52	A1 – 4	BL20-2DO-R-CO	408	BL20-PKZM0-XRM32	444
451	A1 – 2	BL20-2DO-R-NC	406	BL20-QV/1	343
452	A1 – 2	BL20-2DO-R-NO	404	BL20-QV/2	343
572	A1 – 2	BL20-2RFID-A	434	BL20-QV/3	343
841	A1 – 2	BL20-2RFID-C	436	BL20-QV/4	343
843	A1 – 2	BL20-32DI-24VDC-P	380	BL20-QV/5	343
5711	A1 – 2	BL20-32DO-24VDC-0.5A-P	418	BL20-QV/6	343
5723	A1 – 2	BL20-4AI-U/I	394	BL20-QV/7	343
441/S2174	A1 – 2	BL20-4DI-24VDC-N	370	BL20-QV/8	343
4MBM8-4P2-7/8-M	127	BL20-4DI-24VDC-P	368	BL20-SCH-1	344
6ES7972-0BA12-0XA0	A3 – 5	BL20-4DI-NAMUR	372	BL20-SWIRE-CAB-000 (25pcs)	448
6ES7972-0BA50-0XA0	A3 – 5	BL20-4DO-24VDC-0.5A-P	410	BL20-SWIRE-CAB-008 (25pcs)	448
6ES7972-0BB50-0XA0	A3 – 5	BL20-ABPL	344	BL20-SWIRE-CAB-011 (25pcs)	448
6GK1500-0FC00	A3 – 5	BL20-ANBZ-BL	343	BL20-SWIRE-CAB-015 (5pcs)	448
6GK1901-1BB10-2AA0/FC-RJ45	A3 – 20	BL20-ANBZ-BL	343	BL20-SWIRE-CAB-025 (5pcs)	448
8MBM8-4P2-7/8-M	127	BL20-ANBZ-BR	343	BL20-SWIRE-CAB-050	448
B3.0/2-PKZ0	448	BL20-ANBZ-GN	343	BL20-SWIRE-CAB-100	448
B3.0/4-PKZ1	448	BL20-ANBZ-GN/GE-BED	343	BL20-SWIRE-CAB-200	448
B4148-0/9	A4 – 6	BL20-ANBZ-RT	343	BL20-SWIRE-DIL(5pcs)	444
B4151-0/13.5	A3 – 15	BL20-ANBZ-RT/BL-BED	343	BL20-SWIRE-PF	448
B4151-0/9	A3 – 14	BL20-ANBZ-SW	343	BL20-WEW-35/2-SW	344
B4151-0/9	A4 – 3	BL20-ANBZ-WS	343	BL20-ZBX-405	344
B4251-0/9	A3 – 14	BL20-BR-24VDC-D	356	BL67-16DO-0.1A-P	68
B4251-0/9	A4 – 3	BL20-E-16DI-24VDC-P	378	BL67-1CNT/ENC	100
B5131-0	A5 – 12	BL20-E-16DO-24VDC-0.5A-P	416	BL67-1CVI	102
B5133-0	A5 – 12	BL20-E-1SWIRE	438	BL67-1RS232	94
B5141-0	A5 – 12	BL20-E-8DI-24VDC-P	374	BL67-1RS485/422	96
B5143-0	A5 – 12	BL20-E-8DO-24VDC-0.5A-P	412	BL67-1SSI	98
B5231-0	A5 – 12	BL20-E-GW-CO	350	BL67-2AI-I	80
B5241-0	A5 – 12	BL20-E-GW-DP	347	BL67-2AI-PT	86
B8151-0	A5 – 14	BL20-FW5/101-150	343	BL67-2AI-TC	88
B8151-0/9	A3 – 15	BL20-FW5/1-50	343	BL67-2AI-V	82
B8181-0	A5 – 14	BL20-FW5/151-200	343	BL67-2AO-I	90
B8251-0	A5 – 14	BL20-FW5/51-100	343	BL67-2AO-V	92
B8251-0/9	A3 – 16	BL20-GWBR-CANOPEN	349	BL67-2RFID-A	104
BIC-44-E424	A3 – 20	BL20-GWBR-DNET	348	BL67-2RFID-C	106
BK25/3-PKZ0	448	BL20-GW-DPV1	346	BL67-4AI-V/I	84
BL20-16DI-24VDC-P	376	BL20-GW-EN	351	BL67-4DI4DO-PD	76
BL20-16DO-24VDC-0.5A-P	414	BL20-GW-EN-IP	352	BL67-4DI-N	58
BL20-1AI-I(0/4...20MA)	382	BL20-KLBU/S	344	BL67-4DI-P	50
BL20-1AI-U(-10/0...+10VDC)	384	BL20-KLBU/T	344	BL67-4DI-PD	54
BL20-1AO-I(0/4...20MA)	420	BL20-KO/10	343	BL67-4DO-0.5A-P	62
BL20-1CNT-24VDC	426	BL20-KO/11	343	BL67-4DO-2A-N	70
BL20-1RS232	428	BL20-KO/12	343	BL67-4DO-2A-P	64
BL20-1RS485/422	430	BL20-KO/13	343	BL67-8DI-N	60
BL20-1SSI	432	BL20-KO/14	343	BL67-8DI-P	52
BL20-2AI-I(0/4...20MA)	386	BL20-KO/16	343	BL67-8DI-PD	56
BL20-2AI-PT/NI-2/3	390	BL20-KO/17	343	BL67-8DO-0.5A-N	72
BL20-2AI-THERMO-PI	392	BL20-KO/2	343	BL67-8DO-0.5A-P	66
BL20-2AI-U(-10/0...+10VDC)	388	BL20-KO/6	343	BL67-8DO-R-NO	74
BL20-2AO-I(4...20MA)	422	BL20-KO/8	343	BL67-8XSG-PD	78
BL20-2AO-U(-10/0...+10VDC)	424	BL20-KO/9	343	BL67-GW-CO	40
BL20-2DI-120/230VAC-P	366	BL20-LABEL/BLOCK	343	BL67-GW-CO-T	41
BL20-2DI-24VDC-N	364	BL20-LABEL/SCHEIBE	343	BL67-GW-DN	39
BL20-2DI-24VDC-P	362	BL20-PF-120/230VAC-D	360	BL67-GW-DPV1	38
BL20-2DO-120/230VAC-0.5A	402	BL20-PF-24VDC-D	358	BL67-GW-EN	42
BL20-2DO-24VDC-0.5A-N	398	BL20-PG-EN	353	BL67-GW-EN-IP	44
BL20-2DO-24VDC-0.5A-P	396	BL20-PG-EN-IP	354	BL67-GW-EN-PN	43

Type	Page	Type	Page	Type	Page
BL67-PF-24VDC	48	EC-FKFDW4.54-0,5/16	A3 – 6	FSM4-2WAK3-0,3/0,3/S90	A5 – 20
BL67-PG-DP	45	EC-FSDW4.54-0,5/16	A3 – 6	FSM4-2WAK3-0,3/0,3/XOR	A5 – 20
BL67-PG-EN	46	EC-FSFDW4.54-0,5/16	A3 – 6	FSM4-2WAK3-0,6/0,6/P00	A5 – 20
BL67-PG-EN-IP	47	EL-0002	126	FSM4-2WAK3-0,6/0,6/S90	A5 – 20
BMSWS8251-8,5	A3 – 4	FDN20-16S	324	FSM4-2WAK3-0,6/0,6/XOR	A5 – 20
BMWS8251-8,5	A3 – 4	FDN20-16XSG	323	FSM4-2WAK3-1/1/P00	A5 – 20
BS4148-0/9	A4 – 6	FDN20-4S-4XSG	321	FSM4-2WAK3-1/1/S90	A5 – 20
BS4151-0/13.5	A3 – 15	FDN20-4S-4XSG-DIN	322	FSM4-2WAK3-1/1/XOR	A5 – 20
BS4151-0/9	A3 – 14	FDN20-4S-4XSG-E	320	FSM5-2FKM5.4/S55	A5 – 22
BS4151-0/9	A4 – 3	FDN-DN1	A3 – 10	FSM5-2FKM5.4/S55/S1874	A5 – 22
BS4251-0/9	A3 – 14	FDNL-CSG88-T	290	FSM5-2FKM5.4/S55/S2292	A5 – 22
BS4251-0/9	A4 – 3	FDNL-L0800-T	286	FSW4.54-0,5	A3 – 8
BS5131-0	A5 – 12	FDNL-L1600-T	289	FSW5L	A3 – 8
BS5133-0	A5 – 12	FDNL-N0800-T	285	FW-M12KU5D-G-SB-ME-SH-8	A3 – 20
BS5141-0	A5 – 12	FDNL-N1600-T	288	FW-M12KU5W-G-ZF-ME-SH-9	A3 – 4
BS5143-0	A5 – 12	FDNL-S0800-T	284	FW-M12ST5D-G-SB-ME-SH-8	A3 – 20
BS5231-0	A5 – 12	FDNL-S1600-T	287	FW-M12ST5W-G-ZF-ME-SH-9	A3 – 4
BS5241-0	A5 – 12	FDNP-CPG88-TT	297	FW-M23KU17Q-G-CP-ME-SH-14.5	A5 – 18
BS8151-0	A5 – 14	FDNP-L0404G-TT	295	FW-M23KU17Q-W-CP-ME-SH-14.5	A5 – 18
BS8151-0/9	A3 – 15	FDNP-L0808G-TT	298	FW-M23ST12Q-G-CP-ME-XX-10	A5 – 18
BS8181-0	A5 – 14	FDNP-L0808H-TT	300	FW-M23ST12Q-G-LT-ME-XX-10	A5 – 18
BS8251-0	A5 – 14	FDNP-P0808H-TT	299	FW-M23ST17Q-G-CP-ME-SH-14.5	A5 – 18
BS8251-0/9	A3 – 16	FDNP-P1204G-TT	301	FW-M23ST17Q-W-CP-ME-SH-14.5	A5 – 18
CBC5-5711-0,5M	A1 – 26	FDNP-S0008G-TT	292	FW-M23ST19Q-G-CP-ME-XX-10	A5 – 18
CBC5-5711-1M	A1 – 26	FDNP-S0008H-TT	293	FW-M23ST19Q-G-LT-ME-XX-10	A5 – 18
CBC5-5711-2M	A1 – 26	FDNP-S0404G-TT	294	FXDP-CSG88-0001	261
CBC5-572-0,5M	A1 – 26	FDNP-S0808G-TT	296	FXDP-IM16-0001	257
CBC5-572-1M	A1 – 26	FDNP-S0808G-TT	296	FXDP-IM8-0001	256
CBC5-572-2M	A1 – 26	FDNP-XSG16-TT	302	FXDP-IOM88-0001	260
CBC5-5723-0,5M	A1 – 26	FDP20-16S	319	FXDP-OM16-0001	259
CBC5-5723-1M	A1 – 26	FDP20-16XSG	318	FXDP-OM8-0001	258
CBC5-5723-2M	A1 – 26	FGDP-IM16-0001	264	FXDP-XSG16-0001	262
CBC5-5723-2M	A1 – 26	FGDP-IOM88-0001	265	FXEN-IM16-0001-IP	310
CMBS8151-0	A5 – 16	FK57	A3 – 17	FXEN-IM16-0001-IP-DN	311
CMBS8251-0	A5 – 16	FKDW4.54-0,5	A3 – 7	FXEN-IM16-0001-MB	308
CPV10-VI-IP8-8	198	FKFDW4.54-0,5	A3 – 7	FXEN-IM16-0001-PN	313
CPV14-VI-IP8-8	198	FKM-FS57-M12	A3 – 18	FXEN-XSG16-0001-IP	312
D9-451-0,5M-0,5M	A1 – 10	FKSDD-RJ45SF-44	A3 – 20	FXEN-XSG16-0001-MB	309
D9-451-1M-1M	A1 – 10	FKW4.54-0,5	A3 – 7	FXEN-XSG16-0001-PN	314
D9-451-2M-2M	A1 – 10	FKW5L	A3 – 7	H5231-0	A5 – 12
D9T451-0,5M	A1 – 12	FKW-FSW45-M12	A3 – 9	H5241-0	A5 – 12
D9T451-1M	A1 – 12	FLDP-IM16-0001	268	HA5131-0	A5 – 12
D9T451-2M	A1 – 12	FLDP-IM32-0001	269	HA5141-0	A5 – 12
DILM12-01(24VDC)	444	FLDP-IM8-0001	267	HA8141-0	A5 – 14
DILM12-10(24VDC)	444	FLDP-IOM1616-0001	276	HA8241-0	A5 – 14
DILM12-XMV	448	FLDP-IOM2012-0001	277	HAS5131-0	A5 – 12
DILM12-XMV	444	FLDP-IOM248-0001	279	HAS5141-0	A5 – 12
DILM17-01(RDC24)*	444	FLDP-IOM84-0001	273	HAS8141-0	A5 – 14
DILM17-10(RDC24)*	444	FLDP-IOM88-0001	274	HAS8241-0	A5 – 14
DILM25-01(RDC24)*	444	FLDP-IOM88-0002	275	H-B3-PKZ0(20pcs)	448
DILM25-10(RDC24)*	444	FLDP-OM16-0001	272	HS5231-0	A5 – 12
DILM32-01(RDC24)*	444	FLDP-OM8-0001	270	HS5241-0	A5 – 12
DILM32-10(RDC24)*	444	FLDP-OM8-0002	271	I/O-ASSISTANT-Kabel-BL20/BL67	342
DILM32-XMV	448	FS57	A3 – 17	I/O-ASSISTANT-KABEL-PICONET	125
DILM32-XMV	444	FSDW4.54-0,5	A3 – 8	IPSKP4-0,12-SSP4/S90	A2 – 10
DILM7-01(24VDC)	444	FSFDW4.54-0,5	A3 – 8		
DILM7-10(24VDC)	444	FSM-2FKM57	A3 – 11		
DILM9-01(24VDC)	444	FSM4-2FKM3/S89	A5 – 22		
DILM9-10(24VDC)	444	FSM4-2FKM3P3/S89	A5 – 22		
EC-FKDW4.54-0,5/16	A3 – 6	FSM4-2WAK3-0,3/0,3/P00	A5 – 20		

Type	Page	Type	Page	Type	Page
IPSKP4-0,12-SSP4/S90/S2154	124	PKZM0-0,63	444	RKM52-5-RSM52	A2 – 2
IPSKP4-0,15-SSP4/S90	A2 – 10	PKZM0-1	444	RKM52-6M	A2 – 2
IPSKP4-0,5-SSP4/S90	A2 – 10	PKZM0-1,6	444	RKM52-6-RSM52	A2 – 2
IPSKP4-10/S90	A2 – 10	PKZM0-1,6	444	RKM5711-10M	A1 – 18
IPSKP4-1-SSP4/S90	A2 – 10	PKZM0-10	444	RKM5711-15M	A1 – 18
IPSKP4-2/S90	A2 – 10	PKZM0-10	444	RKM5711-1M	A1 – 18
IPSKP4-2-SSP4/S90	A2 – 10	PKZM0-12	444	RKM5711-6M	A1 – 18
IPSKP4-5/S90	A2 – 10	PKZM0-16	444	RKM5723-10M	A1 – 22
IPSKP4-5-SSP4/S90	A2 – 10	PKZM0-16	444	RKM5723-15M	A1 – 22
IPSWKP4-0,15-SWSP4/S90	A2 – 10	PKZM0-2,5	444	RKM5723-6M	A1 – 22
IPSWKP4-0,5-SWSP4/S90	A2 – 10	PKZM0-25	444	RKM57-TR2	A3 – 13
IPSWKP4-10/S90	A2 – 10	PKZM0-32	444	RKM-CBC5-5711-0,5M	A1 – 26
IPSWKP4-1-SWSP4/S90	A2 – 10	PKZM0-4	444	RKM-CBC5-5711-1M	A1 – 26
IPSWKP4-2/S90	A2 – 10	PKZM0-4	444	RKM-CBC5-5711-2M	A1 – 26
IPSWKP4-2-SWSP4/S90	A2 – 10	PKZM0-6,3	444	RKM-CBC5-5723-0,5M	A1 – 26
IPSWKP4-5/S90	A2 – 10	RC-Z2099	A5 – 18	RKM-CBC5-5723-1M	A1 – 26
IPSWKP4-5-SWSP4/S90	A2 – 10	REP-DN	A3 – 10	RKM-CBC5-5723-2M	A1 – 26
ISK-M8	A5 – 25	REP-DP 0002	A3 – 2	RKM-CC	A5 – 24
JBBS-57-E411	A3 – 13	RJ45-FKSDD-441-0,5M/S2174	A2 – 2	RKSD-RJ45-441-0,5M/S2174	A2 – 2
JBBS-57-E811-VM	A3 – 13	RKC572-10M	A1 – 14	RKSW-2RSSW45-0001	A3 – 2
KABEL441-100M/S2174	A1 – 28	RKC572-15M	A1 – 14	RKSW451-10M	A1 – 6
KABEL451-150M	A1 – 6	RKC572-1M	A1 – 14	RKSW451-15M	A1 – 6
KABEL451-30M	A1 – 6	RKC572-2M	A1 – 14	RKSW451-1M	A1 – 6
KABEL451-500M	A1 – 6	RKC572-5M	A1 – 14	RKSW451-20M	A1 – 6
KABEL452-150M	A1 – 6	RKC572-6M	A1 – 14	RKSW451-2M	A1 – 6
KABEL452-300M	A1 – 6	RKC-CBC5-572-0,5M	A1 – 26	RKSW451-3M	A1 – 6
KABEL452-30M	A1 – 6	RKC-CBC5-572-1M	A1 – 26	RKSW451-6M	A1 – 6
KABEL5711-150M	A1 – 18	RKC-CBC5-572-2M	A1 – 26	RKSW-D9-RKSW-451-0,3M-0,3M	A1 – 10
KABEL5711-30M	A1 – 18	RKE57-TR2	A3 – 12	RKSW-D9-RKSW-451-0,5M-0,5M	A1 – 10
KABEL5711-500M	A1 – 18	RKF57	A3 – 17	RKSW-D9-RKSW-451-1M-1M	A1 – 10
KABEL572-150M	A1 – 14	RKF57	A4 – 4	RKSW-D9-RKSW-451-2M-2M	A1 – 10
KABEL572-30M	A1 – 14	RKFL46	A4 – 7	RKSW-D9T451-0,3M	A1 – 12
KABEL5723-150M	A1 – 22	RKM40-RKM40-L-RSM40	A4 – 5	RKSW-D9T451-0,5M	A1 – 12
KABEL5723-30M	A1 – 22	RKM43-0,3-RSM43	A2 – 6	RKSW-D9T451-1M	A1 – 12
KABEL5723-500M	A1 – 22	RKM43-0,5-RSM43	A2 – 6	RKSW-D9T451-2M	A1 – 12
KABEL572-500M	A1 – 14	RKM43-10M	A2 – 6	RKSW-D9T451-6M	A1 – 12
KABEL-DN-43-1000M	A2 – 6	RKM43-10-RSM43	A2 – 6	RKSW5.4.5[5]-2RSSWS	A3 – 2
KABEL-DN-43-100M	A2 – 6	RKM43-15M	A2 – 6	RSC572-0,3M	A1 – 14
KABEL-PDP-52-100M	A2 – 2	RKM43-15-RSM43	A2 – 6	RSC572-1,5M	A1 – 14
KABEL-PDP-52-500M	A2 – 2	RKM43-1-RSM43	A2 – 6	RSC572-10M	A1 – 14
LN1/2-14NPT/10	A4 – 4	RKM43-2-RSM43	A2 – 6	RSC572-15M	A1 – 14
LN1/2-14NPT/10	A4 – 7	RKM43-4-RSM43	A2 – 6	RSC572-2M	A1 – 14
Locknut G1/2"	A4 – 4	RKM43-6M	A2 – 6	RSC572-5M	A1 – 14
Locknut G1/2"	A4 – 7	RKM43-6-RSM43	A2 – 6	RSC572-6M	A1 – 14
LWL-KS-SFOC-0002	123	RKM52-0,3-RSM52	A2 – 2	RSC-CBC5-572-0,5M	A1 – 26
LWL-MG	124	RKM52-0,5-RSM52	A2 – 2	RSC-CBC5-572-1M	A1 – 26
LWL-SL-SFOC-0002	123	RKM52-10M	A2 – 2	RSC-CBC5-572-25M	A1 – 26
MB-4M12-5.4P2-2/S366	A5 – 20	RKM52-10-RSM52	A2 – 2	RSC-CBC5-572-2M	A1 – 26
MB-8M12-5.4P2-5/S366	A5 – 20	RKM52-15M	A2 – 2	RSC-CBC5-572-4M	A1 – 26
MB-SSP4-2SKP32	A5 – 22	RKM52-15-RSM52	A2 – 2	RSC-RKC572-0,3M	A1 – 14
MB-SSP4-2SKP4P3-S2133	A5 – 22	RKM52-1-RSM52	A2 – 2	RSC-RKC572-0,5M	A1 – 14
MB-SSP4-2SKP4-S2133	A5 – 22	RKM52-20-RSM52	A2 – 2	RSC-RKC572-10M	A1 – 14
NHI-E-10L-PKZ0 (5pcs)	444	RKM52-2M	A2 – 2	RSC-RKC572-15M	A1 – 14
PDP-TRA	A3 – 3	RKM52-2-RSM52	A2 – 2	RSC-RKC572-1M	A1 – 14
piconet®-Set-M12	125	RKM52-30M	A2 – 2	RSC-RKC572-20M	A1 – 14
piconet®-Set-M8	125	RKM52-30-RSM52	A2 – 2	RSC-RKC572-2M	A1 – 14
PKZM0-0,25	444	RKM52-3-RSM52	A2 – 2	RSC-RKC572-30M	A1 – 14
PKZM0-0,4	444	RKM52-4M	A2 – 2	RSC-RKC572-4M	A1 – 14
PKZM0-0,63	444	RKM52-4-RSM52	A2 – 2	RSC-RKC572-6M	A1 – 14

Type	Page	Type	Page	Type	Page
RSE57-TR2	A3 – 12	RSSD-RJ45-441-15M/S2174	A2 – 2	SDPB-0002D-1002	234
RSF57	A3 – 17	RSSD-RJ45-441-1M/S2174	A2 – 2	SDPB-0008D-0001	206
RSF57	A4 – 4	RSSD-RJ45-441-25M/S2174	A2 – 2	SDPB-0008D-0002	208
RSFL46	A4 – 7	RSSD-RJ45-441-2M/S2174	A2 – 2	SDPB-0008D-0003	208
RSF-RKF-40/22	A4 – 7	RSSD-RJ45-441-30M/S2174	A2 – 2	SDPB-0008D-0004	210
RSF-RKF-57/22	A3 – 18	RSSD-RJ45-441-40M/S2174	A2 – 2	SDPB-0008D-0005	210
RSF-RKF-57/22	A4 – 4	RSSD-RJ45-441-6M/S2174	A2 – 2	SDPB-0008D-0006	206
RSM-2RKM40	A4 – 5	RSSD-RSSD-441-0,5M/S2174	A2 – 2	SDPB-0008D-1001	206
RSM-2RKM50	A4 – 2	RSSD-RSSD-441-10M/S2174	A2 – 2	SDPB-0008D-1002	208
RSM-2RKM57	A3 – 10	RSSD-RSSD-441-20M/S2174	A2 – 2	SDPB-0008D-1003	208
RSM43-10M	A2 – 6	RSSD-RSSD-441-2M/S2174	A2 – 2	SDPB-0008D-1004	210
RSM43-15M	A2 – 6	RSSD-RSSD-441-30M/S2174	A2 – 2	SDPB-0008D-1005	210
RSM43-6M	A2 – 6	RSSD-RSSD-441-6M/S2174	A2 – 2	SDPB-0008D-1006	206
RSM52-10M	A2 – 2	RSSW451-10M	A1 – 6	SDPB-0202D-0003	236
RSM52-15M	A2 – 2	RSSW451-15M	A1 – 6	SDPB-0202D-1003	236
RSM52-2M	A2 – 2	RSSW451-1M	A1 – 6	SDPB-0404D-0001	214
RSM52-30M	A2 – 2	RSSW451-20M	A1 – 6	SDPB-0404D-0002	214
RSM52-4M	A2 – 2	RSSW451-2M	A1 – 6	SDPB-0404D-0003	212
RSM52-6M	A2 – 2	RSSW451-3M	A1 – 6	SDPB-0404D-0004	212
RSM5711-10M	A1 – 18	RSSW451-6M	A1 – 6	SDPB-0404D-0005	218
RSM5711-15M	A1 – 18	RSSW-D9-RKSW-451-0,3M-0,3M	A1 – 10	SDPB-0404D-0006	218
RSM5711-1M	A1 – 18	RSSW-D9-RKSW-451-0,5M-0,5M	A1 – 10	SDPB-0404D-0007	216
RSM5711-3M	A1 – 18	RSSW-D9-RKSW-451-0,5M-1,5M	A1 – 10	SDPB-0404D-0008	216
RSM5711-6M	A1 – 18	RSSW-D9-RKSW-451-1,5M-1,5M	A1 – 10	SDPB-0404D-1001	214
RSM5723-10M	A1 – 22	RSSW-D9-RKSW-451-1M-1M	A1 – 10	SDPB-0404D-1002	214
RSM5723-15M	A1 – 22	RSSW-D9-RKSW-451-2M-2M	A1 – 10	SDPB-0404D-1003	212
RSM5723-6M	A1 – 22	RSSW-D9-RKSW-451-3M-3M	A1 – 10	SDPB-0404D-1004	212
RSM57-TR2	A3 – 12	RSSW-D9T451-0,3M	A1 – 12	SDPB-0404D-1005	218
RSM-CBC5-5711-0,5M	A1 – 26	RSSW-D9T451-0,5M	A1 – 12	SDPB-0404D-1006	218
RSM-CBC5-5711-1M	A1 – 26	RSSW-D9T451-1M	A1 – 12	SDPB-0404D-1007	216
RSM-CBC5-5711-2M	A1 – 26	RSSW-D9T451-2M	A1 – 12	SDPB-0404D-1008	216
RSM-CBC5-5723-0,5M	A1 – 26	RSSW-RKSW451-0,2M	A1 – 6	SDPB-04A-0007	230
RSM-CBC5-5723-1M	A1 – 26	RSSW-RKSW451-0,3M	A1 – 6	SDPB-04A-0009	232
RSM-CBC5-5723-2M	A1 – 26	RSSW-RKSW451-0,5M	A1 – 6	SDPB-04A-1007	230
RSM-CC	A5 – 24	RSSW-RKSW451-1,5M	A1 – 6	SDPB-04A-1009	232
RSM-DUST-CAP	A5 – 24	RSSW-RKSW451-10M	A1 – 6	SDPB-0800D-0002	204
RSM-FKM-RKM57	A3 – 10	RSSW-RKSW451-12M	A1 – 6	SDPB-0800D-0004	202
RSM-RKM5711-0,3M	A1 – 18	RSSW-RKSW451-15M	A1 – 6	SDPB-0800D-0007	202
RSM-RKM5711-0,5M	A1 – 18	RSSW-RKSW451-1M	A1 – 6	SDPB-0800D-0008	204
RSM-RKM5711-10M	A1 – 18	RSSW-RKSW451-2M	A1 – 6	SDPB-0800D-1002	204
RSM-RKM5711-15M	A1 – 18	RSSW-RKSW451-30M	A1 – 6	SDPB-0800D-1004	202
RSM-RKM5711-1M	A1 – 18	RSSW-RKSW451-3M	A1 – 6	SDPB-0800D-1007	202
RSM-RKM5711-2M	A1 – 18	RSSW-RKSW451-4M	A1 – 6	SDPB-0800D-1008	204
RSM-RKM5711-30M	A1 – 18	RSSW-RKSW451-5M	A1 – 6	SDPB-0808D-0001	220
RSM-RKM5711-3M	A1 – 18	RSSW-RKSW451-6M	A1 – 6	SDPB-0808D-1001	220
RSM-RKM5711-4M	A1 – 18	RSSW-RKSW451-7M	A1 – 6	SDPB-10S-0001	238
RSM-RKM5711-6M	A1 – 18	RSSW-RKSW451-8M	A1 – 6	SDPB-10S-0002	240
RSM-RKM5723-0,3M	A1 – 22	S89/VB2-Befestigungsset	A3 – 3	SDPB-10S-0003	242
RSM-RKM5723-0,5M	A1 – 22	S-BKT1	126	SDPB-10S-0004	244
RSM-RKM5723-10M	A1 – 22	S-BKT2	126	SDPB-10S-0005	246
RSM-RKM5723-15M	A1 – 22	SCOL-0404D-0003	136	SDPB-10S-1001	238
RSM-RKM5723-1M	A1 – 22	SCOL-0404D-0004	136	SDPB-10S-1002	240
RSM-RKM5723-2M	A1 – 22	SCOL-0404D-1003	136	SDPB-10S-1003	242
RSM-RKM5723-30M	A1 – 22	SCOL-0404D-1004	136	SDPB-10S-1004	244
RSM-RKM5723-4M	A1 – 22	SDNL-0404D-0003	134	SDPB-10S-1005	246
RSM-RKM5723-6M	A1 – 22	SDNL-0404D-0004	134	SDPB-40A-0004	228
RSS4.5-PDP-TR	A3 – 3	SDNL-0404D-1003	134	SDPB-40A-0005	222
RSSD-RJ45-441-0,5M/S2174	A2 – 2	SDNL-0404D-1004	134	SDPB-40A-0007	224
RSSD-RJ45-441-10M/S2174	A2 – 2	SDPB-0002D-0002	234	SDPB-40A-0009	226

Type	Page	Type	Page	Type	Page
SDPB-40A-1004	228	SNNE-0404D-0007	164	VZ 3	A5 – 24
SDPB-40A-1005	222	SNNE-0404D-0008	164	VZ 8	A5 – 24
SDPB-40A-1007	224	SNNE-04A-0007	180	WAK3-1,5-SSP3/S90	A5 – 8
SDPB-40A-1009	226	SNNE-04A-0009	182	WAK3-10-SSP3/S90	A5 – 8
SDPL-0404D-0003	132	SNNE-0800D-0002	150	WAK3-1-SSP3/S90	A5 – 8
SDPL-0404D-0004	132	SNNE-0800D-0004	148	WAK3-1-SWSP3/S90	A5 – 6
SDPL-0404D-1003	132	SNNE-0800D-0007	148	WAK3-2-SSP3/S90	A5 – 8
SDPL-0404D-1004	132	SNNE-0800D-0008	150	WAK3-2-SWSP3/S90	A5 – 6
SE-44M-E924	A3 – 20	SNNE-0808D-0001	168	WAK3-5-SSP3/S90	A5 – 8
SE-44X-E5241	A3 – 19	SNNE-0808D-0003	170	WAK3-5-SWSP3/S90	A5 – 6
SE-44X-E9241	A3 – 19	SNNE-10S-0001	188	WAK4.5-1-WAS4.5/S57	A5 – 10
SENL-0404D-0001	140	SNNE-10S-0002	190	WAK4.5-20-WAS4.5/S57	A5 – 10
SENL-0404D-0002	140	SNNE-10S-0003	192	WAK4.5-2-WAS4.5/S57	A5 – 10
SENL-0404D-0003	140	SNNE-10S-0004	194	WAK4.5-5-WAS4.5/S57	A5 – 10
SENL-0404D-0004	140	SNNE-10S-0005	196	WAK4-2-WAS4/S90	A5 – 8
SFOB-0001	124	SNNE-40A-0004	178	WAK4-2-WAS4/XOR	A5 – 8
SFOC-0002-10	123	SNNE-40A-0005	172	WAK4-5-WAS4/P00	A5 – 8
SFOF-500M-ROLLE	123	SNNE-40A-0007	174	WAK4-5-WAS4/S90	A5 – 8
SFOF-xM	123	SNNE-40A-0009	176	WAK4-5-WAS4/XOR	A5 – 8
SFOL-0,25M	122	SNNE-BL I/O 3,5-10/LED-SET	125	WAS4.5-10/S57	A5 – 10
SFOL-0,2M	122	SNNE-BL I/O 3,5-30/LED-SET	125	WAS4.5-2/S57	A5 – 10
SFOL-0,3M	122	SNNE-RAIL500	124	WAS4.5-5/S57	A5 – 10
SFOL-0,5M	122	SPNL-0404D-0003	144	WAS4-1/S90	A5 – 8
SFOL-10M	122	SPNL-0404D-0004	144	WAS4-10/S90	A5 – 8
SFOL-15M	122	SSP3-10/S90	A5 – 2	WAS4-2/S90	A5 – 8
SFOL-1M	122	SSP3-2/S90	A5 – 2	WAS4-5/S90	A5 – 8
SFOL-2M	122	SSP3-5/S90	A5 – 2	WAS5-THERMO	126
SFOL-3M	122	SSP4-10/S90	A5 – 6	WKC572-10M	A1 – 16
SFOL-5M	122	SSP4-2/S90	A5 – 6	WKC572-15M	A1 – 16
SIBL-0404D-0003	138	SSP4-5/S90	A5 – 6	WKC572-1M	A1 – 16
SIBL-0404D-0004	138	SSPC 3K	A5 – 12	WKC572-2M	A1 – 16
SIPL-0404D-0003	142	SUB-D-IP67	125	WKC572-5M	A1 – 16
SIPL-0404D-0004	142	SW-I/O-ASSISTANT	125	WKC572-6M	A1 – 16
SKP3-1,5-SSP3/S90	A5 – 4	SWKP3-1,5-SSP3/S90	A5 – 4	WKM43-0,3-WSM43	A2 – 8
SKP3-1,5-SWSP3/S90	A5 – 4	SWKP3-10/S90	A5 – 2	WKM43-0,5-WSM43	A2 – 8
SKP3-10/S90	A5 – 2	SWKP3-1-SSP3/S90	A5 – 4	WKM43-10M	A2 – 8
SKP3-1-SSP3/S90	A5 – 4	SWKP3-1-SWSP3/S90	A5 – 6	WKM43-10-WSM43	A2 – 8
SKP3-1-SWSP3/S90	A5 – 4	SWKP3-2/S90	A5 – 2	WKM43-15M	A2 – 8
SKP3-2/S90	A5 – 2	SWKP3-2-SSP3/S90	A5 – 4	WKM43-15-WSM43	A2 – 8
SKP3-2-SSP3/S90	A5 – 4	SWKP3-2-SWSP3/S90	A5 – 6	WKM43-1-WSM43	A2 – 8
SKP3-2-SWSP3/S90	A5 – 4	SWKP3-5/S90	A5 – 2	WKM43-2-WSM43	A2 – 8
SKP3-5/S90	A5 – 2	SWKP3-5-SSP3/S90	A5 – 4	WKM43-4-WSM43	A2 – 8
SKP3-5-SSP3/S90	A5 – 4	SWKP3-5-SWSP3/S90	A5 – 6	WKM43-6M	A2 – 8
SKP3-5-SWSP3/S90	A5 – 4	SWSP3-10/S90	A5 – 2	WKM43-6-WSM43	A2 – 8
SNNE-0002D-0002	184	SWSP3-2/S90	A5 – 2	WKM52-0,3-WSM52	A2 – 4
SNNE-0008D-0001	152	SWSP3-5/S90	A5 – 2	WKM52-0,5-WSM52	A2 – 4
SNNE-0008D-0002	154	SWSP4-10/S90	A5 – 6	WKM52-0.5M	A2 – 4
SNNE-0008D-0003	154	SWSP4-2/S90	A5 – 6	WKM52-10M	A2 – 4
SNNE-0008D-0004	156	SWSP4-5/S90	A5 – 6	WKM52-10-WSM52	A2 – 4
SNNE-0008D-0005	156	VB2-FKM-FKM-FSM57	A3 – 11	WKM52-15M	A2 – 4
SNNE-0008D-0006	152	VB2-FKM-FKM-RSC572-1M	A3 – 12	WKM52-15-WSM52	A2 – 4
SNNE-0016D-0002	158	VB2-FKM-RKC-RSC572-0,5M-0,5M	A3 – 11	WKM52-1-WSM52	A2 – 4
SNNE-0202D-0003	186	VB2-FSW/RSSW-RKSW455-0.5M-0.5M	A3 – 3	WKM52-2M	A2 – 4
SNNE-0404D-0001	162	VB2-FSW-FKW-FSW-45	A3 – 2	WKM52-2-WSM52	A2 – 4
SNNE-0404D-0002	162	VB2-RKC572-1M-FKM-FSM	A3 – 11	WKM52-30-WSM52	A2 – 4
SNNE-0404D-0003	160	VK-M12	A5 – 25	WKM52-4M	A2 – 4
SNNE-0404D-0004	160	VS-M12	A5 – 25	WKM52-4-WSM52	A2 – 4
SNNE-0404D-0005	166			WKM52-6M	A2 – 4
SNNE-0404D-0006	166			WKM52-6-WSM52	A2 – 4

Type	Page	Type	Page
WKM5711-10M	A1 – 20	WSSW-WKSW451-15M	A1 – 8
WKM5711-15M	A1 – 20	WSSW-WKSW451-1M	A1 – 8
WKM5711-6M	A1 – 20	WSSW-WKSW451-2M	A1 – 8
WKM5723-10M	A1 – 24	WSSW-WKSW451-30M	A1 – 8
WKM5723-15M	A1 – 24	WSSW-WKSW451-4M	A1 – 8
WKM5723-6M	A1 – 24	WSSW-WKSW451-6M	A1 – 8
WKSW451-10M	A1 – 8	WWAK3-1-SSP3/S90	A5 – 6
WKSW451-15M	A1 – 8	WWAK3-1-SWSP3/S90	A5 – 6
WKSW451-2M	A1 – 8	WWAK3-2-SSP3/S90	A5 – 6
WKSW451-6M	A1 – 8	WWAK3-2-SWSP3/S90	A5 – 6
WSC572-10M	A1 – 16	WWAK3-5-SSP3/S90	A5 – 6
WSC572-15M	A1 – 16	WWAK3-5-SWSP3/S90	A5 – 6
WSC572-2M	A1 – 16	WWAS4-10/S90	A5 – 8
WSC572-6M	A1 – 16	WWAS4-2/S90	A5 – 8
WSC-WKC572-0,3M	A1 – 16	WWAS4-5/S90	A5 – 8
WSC-WKC572-0,5M	A1 – 16	ZBW5	344
WSC-WKC572-10M	A1 – 16		
WSC-WKC572-15M	A1 – 16		
WSC-WKC572-1M	A1 – 16		
WSC-WKC572-2M	A1 – 16		
WSC-WKC572-30M	A1 – 16		
WSC-WKC572-4M	A1 – 16		
WSC-WKC572-6M	A1 – 16		
WSM43-10M	A2 – 8		
WSM43-15M	A2 – 8		
WSM43-6M	A2 – 8		
WSM52-10M	A2 – 4		
WSM52-15M	A2 – 4		
WSM52-6M	A2 – 4		
WSM5711-10M	A1 – 20		
WSM5711-15M	A1 – 20		
WSM5711-6M	A1 – 20		
WSM5723-10M	A1 – 24		
WSM5723-15M	A1 – 24		
WSM5723-6M	A1 – 24		
WSM-WKM5711-0,3M	A1 – 20		
WSM-WKM5711-0,5M	A1 – 20		
WSM-WKM5711-10M	A1 – 20		
WSM-WKM5711-15M	A1 – 20		
WSM-WKM5711-1M	A1 – 20		
WSM-WKM5711-2M	A1 – 20		
WSM-WKM5711-30M	A1 – 20		
WSM-WKM5711-4M	A1 – 20		
WSM-WKM5711-6M	A1 – 20		
WSM-WKM5723-0,3M	A1 – 24		
WSM-WKM5723-0,5M	A1 – 24		
WSM-WKM5723-10M	A1 – 24		
WSM-WKM5723-15M	A1 – 24		
WSM-WKM5723-1M	A1 – 24		
WSM-WKM5723-2M	A1 – 24		
WSM-WKM5723-30M	A1 – 24		
WSM-WKM5723-4M	A1 – 24		
WSM-WKM5723-6M	A1 – 24		
WSSW451-10M	A1 – 8		
WSSW451-15M	A1 – 8		
WSSW451-6M	A1 – 8		
WSSW-WKSW451-0,3M	A1 – 8		
WSSW-WKSW451-0,5M	A1 – 8		
WSSW-WKSW451-10M	A1 – 8		

### TURCK WORLD-WIDE HEADQUARTERS

#### GERMANY

Hans Turck GmbH & Co. KG  
Witzlebenstraße 7  
45472 Mülheim an der Ruhr  
P. O. Box 45466 Mülheim an der Ruhr  
Tel. +49 208 4952-0  
Fax +49 208 4952-264  
E-Mail more@turck.com

#### BAHRAIN

TURCK Middle East S.P.  
P.O. Box 18370  
Manama - Kingdom of Bahrain  
Tel. +973 17 814920  
Fax +973 17 814925  
E-Mail turckmiddleeast@turck.com

#### BELGIUM

Multiprox N. V.  
P. B. 71  
Lion d'Orweg 12  
9300 Aalst  
Tel. +32 53 766566  
Fax +32 53 783977  
E-Mail mail@multiprox.be

#### CZECH REPUBLIC

TURCK s.r.o.  
Hradecká 1151  
500 03 Hradec Králové 3  
Tel. +420 49 5518-766  
Fax +420 49 5518-767  
E-Mail czech@turck.com

#### PR OF CHINA

TURCK (Tianjin) Sensor Co. Ltd.  
18,4th Xinghuazhi Road,  
Xiqing Economic  
Development Area,  
300381 Tianjin  
Tel. +86 22 83988-188  
83988-199  
Fax +86 22 83988-111  
E-Mail turcktj@public1.tpt.tj.cn

#### FRANCE

TURCK BANNER S.A.S  
3, Rue de Courtalin  
Magny-Le-Hongre  
77703 Marne-La-Vallée Cedex 4  
Tel. +33 1 6043-6070  
Fax +33 1 6043-1018  
E-Mail info@turckbanner.fr

#### GREAT BRITAIN

TURCK BANNER LIMITED  
Blenheim House  
Hurricane Way  
Wickford, Essex SS11 8YT  
Tel. +44 1268 578888  
Fax +44 1268 763648  
E-Mail info@turckbanner.co.uk

#### HUNGARY

TURCK Hungary kft.  
Könyves Kalman Krt.76  
1087 Budapest  
Tel. +36 1 4770-740  
Fax +36 1 4770-741  
E-Mail hungary@turck.com

#### INDIA

TURCK India Automation Pvt Ltd.  
A-603/604, ICC Trade Towers,  
6th Floor, Senapati Bapat Road,  
Pune - 411016,  
Maharashtra - India  
Tel. +91 20 25630039  
25630040  
Fax +91 20 25630040  
E-Mail sales.india@turck.com

#### ITALY

TURCK BANNER S. R. L.  
Via S.Domenico, 5  
20010 Bareggio (MI)  
Tel. +39 02 90364-291  
Fax +39 02 90364-838  
E-Mail info@turckbanner.it

#### JAPAN

TURCK Japan Corporation  
#202 MBD Bldg. 2F, 3-3-23,  
Minami-Aoyama,  
Minato-ku, 107-0062, Tokyo,  
Japan  
Tel. +81 3 57722820  
Fax +81 3 34082571  
E-Mail info@turck.jp

#### KOREA

TURCK Korea Co. Ltd.  
Room No 406, Gyeonggi  
Technopark  
1271-11, Sa 1-Dong,  
Sangnok-Gu, Ansan-city,  
Gyeonggi-Do, Korea  
Tel. +82 31 5004-555  
Fax +82 31 5004-558  
E-Mail sensor@sensor.co.kr

#### MEXICO

TURCK Mexico S. DE R.L. DE C.V.  
Carr. Saltillo-Zacatecas km 4.5 s/n  
Parque Industrial "La Angostura"  
Saltillo, COAH. 25070  
Tel. +52 844 4826-924  
Fax +52 844 4826-926  
E-Mail ventasmexico@turck.com

#### THE NETHERLANDS

TURCK B. V.  
Postbus 297  
8000 AG Zwolle  
Tel. +31 38 4227-750  
Fax +31 38 4227-451  
E-Mail info@turck.nl

#### POLAND

TURCK sp.z o.o  
Zeromskiego 1  
45-053 Opole  
Tel. +48 77 4434-800  
Fax +48 77 4434-801  
E-Mail poland@turck.com

#### ROMANIA

TURCK Automation Romania SRL  
Str. Iuliu Tetrat nr. 18 Sector 1  
011914 Bukarest  
Tel. +40 21 2300279  
2300594  
Fax +40 21 2314087  
E-Mail: romania@turck.com

#### RUSSIA

TURCK Rus O.O.O.  
Altufyevskoe shosse, 1/7  
127106 Moskau  
Tel. +7 495 2342661  
Fax +7 495 2342665  
E-Mail russia@turck.com

#### SINGAPORE

TURCK Singapore Pte. Ltd.  
25 International Business Park  
#03-22/23 German Centre  
609916 Singapore  
Tel. +65 65628716  
Fax +65 65628719  
E-Mail singapore@turck.com

#### USA

TURCK Inc.  
3000 Campus Drive  
Minneapolis, MN 55441-2656  
Tel. +1 763 553-9224  
553-7300  
Fax +1 763 553-0708  
E-Mail mailbag@turck.com

[www.turck.com](http://www.turck.com)

D301053 1107

